

# **Stellingen**

behorende bij het proefschrift

# **Closed-Loop Identification Issues in the Process Industry**

Alexander C. van der Klauw  
Delft, 9 januari 1995

1. Met het oog op regelaarontwerp is de verkleining van de variantie van de frequentiefunctie een geschikt doel voor het ontwerpen van eeningangssignaal voor identificatie.

*Dit proefschrift*

2. Gelet op de beïnvloedbaarheid van de modellfout verdient de Generalized Identification methode de voorkeur boven andere gesloten-lus identificatiemethoden.

*Dit proefschrift*

3. Modelvalidatie zou niet alleen gericht moeten zijn op het nagaan of een model een proces goed beschrijft, maar ook op de vraag of het model een goede regelaar oplevert.

*Dit proefschrift*

4. Het kan niet worden bewezen dat het iteratieve schema van identificatie en regelaarontwerp, zoals gepresenteerd in Figuur 4.1 van dit proefschrift, convergeert.

*Dit proefschrift*

5. Vaak hebben economische systemen een niet-minimumfase gedrag (inverse responsie). Hierdoor zijn de korte-termijn gevolgen van bestuurlijke regelacties conflicterend met de uiteindelijke doelstellingen, en vaak impopulair. Gezien de korte regeerperiode zal een kabinet niet snel de neiging hebben de planning uit te voeren, waardoor de doelstellingen niet worden gehaald.

6. Het toegenomen aantal gevallen van nekletsel (bijv. whip-lash) bij auto-ongevallen is mede een gevolg van de gordelspanner, die de autogordel abrupt spant. Het verdient dan ook aanbeveling onderzoek te doen naar een geregelde gordelspanner, die op gecontroleerde wijze de gordel vrijgeeft. Hier ligt een duidelijke taak voor regeltechnici.

7. De introductie van geavanceerde regeltechniek in de praktijk wordt belemmerd doordat de operator niet voldoende inzicht krijgt in de werking van de regelaar. Toekomstig onderzoek dient dan ook mede gericht te zijn op de ontwikkeling van interfaces tussen de operator en het regelsysteem.
8. De regeltechniek ontleent haar bestaansrecht aan onzekerheid.
9. Het is opvallend hoe langzaam multi-media in het onderwijs van een technische faculteit als Elektrotechniek worden geïntroduceerd.
10. Door de economische ontwikkelingen in Azië dreigt Afrika op een nog grotere economische achterstand te worden gezet.
11. De fusie van zelfstandige gymnasia met grotere scholengemeenschappen louter op grond van kostenreductie gaat voorbij aan de waarde van deze vorm van onderwijs voor de gemeenschap.
12. Men is nooit te oud om te leren, maar soms wel te jong.
13. De verregaande bescherming van de eigen beroepsgroep en haar monopolie geeft notarissen de mogelijkheid het begrip "klant is koning" te negeren.

# **Closed-Loop Identification Issues in the Process Industry**

Alexander C. van der Klauw

# Closed-Loop Identification Issues in the Process Industry

PROEFSCHRIFT

ter verkrijging van de graad van doctor  
aan de Technische Universiteit Delft,  
op gezag van de Rector Magnificus Prof. ir. K.F. Wakker,  
in het openbaar te verdedigen ten overstaan van een commissie,  
door het College van Dekanen aangewezen,  
op maandag 9 januari 1995 te 16.00 uur

door

Alexander Christiaan van der KLAUW,

elektrotechnisch ingenieur,

geboren te Enschede

Dit proefschrift is goedgekeurd door de promotor:

**Prof.dr.ir. P.P.J. van den Bosch**

Toegevoegd promotor:

**Dr.ir. P.M.J. Van den Hof**

Leden van de promotiecommissie:

|                                    |                                   |
|------------------------------------|-----------------------------------|
| Rector Magnificus                  | Technische Universiteit Delft     |
| Prof. dr. ir. J. Biemond           | Technische Universiteit Delft     |
| Prof. dr. ir. P.P.J. van den Bosch | Technische Universiteit Eindhoven |
| Prof. dr. ir. P. Eykhoff           | Technische Universiteit Eindhoven |
| Prof. ir. J. Grievink              | Technische Universiteit Delft     |
| Dr. J. Richalet                    | ADERSA                            |
| Dr. ir. P.M.J. Van den Hof         | Technische Universiteit Delft     |
| Prof. ir. H.B. Verbruggen          | Technische Universiteit Delft     |

CIP-DATA KONINKLIJKE BIBLIOTHEEK, DEN HAAG

Klauw, Alexander Christiaan van der

*Closed-loop identification issues in the process industry /*  
Alexander Christiaan van der Klauw. - [S.l. : s.n.]. - Ill.  
Thesis Technische Universiteit Delft. - With index, ref. -  
With summary in Dutch.

ISBN 90-9007804-5

Subject headings: system identification / mathematical modelling.







---

## *Summary*

Control system design in the process industry often involves model-based controllers. To achieve a satisfactory performance, in terms of, e.g., output quality and energy consumption, controllers are designed on the basis of models of the plants to be controlled.

These models are, in general, mathematical black-box models. This means that there is no physical interpretation of the structure of the model and the parameters. They are obtained from measurements of inputs and outputs of the plant, by applying an identification method, such as the Prediction Error Method (PEM), which minimizes a function of the difference between a model output and the plant output. To extract enough information about the dynamics of the plant, the input signal must be designed such that the plant is sufficiently excited.

In the standard PEM approach, it is assumed that the input signal can be chosen freely by the user, such that it is uncorrelated with the disturbances, that act on the plant. Necessarily, the identification experiment, with which the data is obtained, must then be carried out in open loop (with the controller switched off).

However, in the process industry it is generally not possible to carry out an experiment in open loop, and it should be conducted in closed loop. The controller must stay active during most experiments, to guarantee the safety of the plant, its operators and the environment. Moreover, as an identification experiment implies the excitation of the plant by some input signal, the production loses quality, which makes an open-loop identification experiment expensive.

In this thesis it is investigated whether a model can be identified from closed-loop data, such that a (re)designed controller yields a higher performance of the closed-loop system. Taking into account the identification objective, which is the design or improvement of controllers, and the application area, which is the process industry with its specific properties, several issues, related to the stated problem, can be distinguished.

The first issue is closed-loop identification. This is concerned with the problem of how to obtain a model from closed-loop data. A review of existing closed-loop identification methods is given, and a unifying method is presented, which generalizes the methods

that are based on the Prediction Error Method. The proposed Generalized Identification method can provide consistent models, if the model set contains the process.

This situation does not occur in practice, so a bias (model error) will always exist. The Generalized Identification method provides a means to explicitly influence the bias distribution over the frequency domain, by applying appropriate filters to the input-output data. This enables the user to match the bias with specifications from the subsequent controller design step, such as a small bias near the desired closed-loop bandwidth.

The second issue that is addressed is the parametrization problem. The parametrization or model structure of a black-box model is arbitrary, but it determines the conditioning of the parameter estimation problem, and therefore it determines the results of the identification method.

Some known results on dead time estimation and parametrizations with orthonormal basis functions are given, and an algorithm is presented to select a suitable model structure for multivariable systems.

A reparametrization of Single-Input Single-Output (SISO) models yields an orthogonal basis in the regressor space. This result has already been employed in on-line lattice identification algorithms for linear parametrizations. These algorithms are extended to apply to more general parametrizations as well. The proposed lattice algorithms have the same advantages as the existing algorithms, in that they provide models of different order simultaneously, and require fewer calculations than nonlattice implementations.

The third problem at issue concerns control-relevant identification. Considering that the identification objective is to provide a model which is suited for controller design, how can this be taken into account already in the identification procedure?

This area of research has emerged only recently, and several iterative schemes of identification and controller design have been proposed in the literature. They have in common that a model is identified from closed-loop data, subsequently a model-based controller is designed, and implemented to evaluate the achieved performance. If this is not satisfactory, a new iteration is started.

To reduce the number of iterations, and therefore the number of experiments that need to be carried out, an additional iterative loop is added to the existing schemes. In this loop a new model is built from the same data as the previous model, but with different filters, that depend on the designed controller. These filters give control over the bias of the model, and hence the bias can be shaped in such a way that a better controller results. A possible choice of filters is proposed for the iterative scheme of closed-loop identification and LQ controller design, and suitable stop criteria are introduced to decide when to terminate the iterations.

The fourth issue that is considered is input design. The bias of a model is shaped by applying appropriate filters to the data, and the variance of the model is reduced by injecting an appropriately designed excitation signal.

The approach that is followed relies on the relationship between the variance of a model, and the Hessian of the PEM identification criterion. Scalar functions of the Hessian with respect to the model parameters are used to design an excitation signal.

From a controller design viewpoint, the uncertainty of the frequency function estimate is more appropriate to evaluate the quality of a model than the uncertainty of the parameters. Controller properties, such as robustness, are often specified in the frequency domain, and therefore it seems more relevant to try to reduce or influence the variance of the frequency function estimate. This approach results in a new optimal input design method, that is based on the Hessian of the identification criterion with respect to points of the frequency function. This method is developed for both open-loop and closed-loop identification.

The exact location of the excitation signal in the closed loop appears not to influence the identification results, and therefore it can be chosen according to the requirements and restrictions of the process.

Finally, an industrial experiment is conducted. An excitation signal is applied to a multivariable distillation column operating in closed loop, and the resulting data is used to identify models. Due to the short data length in relation to the large number of model parameters, the results cannot be verified with cross-validation. Suggestions are given as to how a future experiment can improve the reliability of the identification results.



---

## *Preface*

The research that is reported on in this dissertation has been financed by the Dutch Technology Foundation (STW), grant DEL92.1980. The project title was *Closed-loop identification in the process industry*, and the purpose was to investigate the possibilities of closed-loop identification to provide models, suited for controller (re)design.

This is a wide problem area, and together with the STW User's Committee we have iteratively refined the problem statement, and defined the research area. This again illustrates the all-important role of feedback, as it is regarded by the control community.

Different aspects of closed-loop identification have been recognized as worthy of investigation, and some of these have been attacked with more or less success.

The result of the investigations is lying in front of you in the form of this thesis. Several different aspects of closed-loop identification have been treated. You can expect a broad discussion, rather than an in-depth analysis.



---

# Contents

|  |            |
|--|------------|
| <b>Summary</b>   | <b>vii</b> |
| <b>Preface</b>   | <b>xi</b>  |
| <b>1 Introduction</b>  | <b>1</b>   |
| 1.1 Identification and control in the process industry . . . . . | 1          |
| 1.2 Problem formulation . . . . .                                | 4          |
| 1.3 Outline . . . . .  | 7          |
| <b>2 Closed-loop identification</b>                              | <b>9</b>   |
| 2.1 Open-loop identification . . . . .                           | 9          |
| 2.1.1 Nonparametric identification . . . . .                     | 10         |
| 2.1.2 Parametric identification . . . . .                        | 12         |
| 2.2 Closed-loop identification problem . . . . .                 | 19         |
| 2.3 Nonparametric identification . . . . .                       | 21         |
| 2.4 Parametric identification . . . . .                          | 22         |
| 2.4.1 Direct Identification method . . . . .                     | 23         |
| 2.4.2 Indirect Identification method . . . . .                   | 25         |
| 2.4.3 Joint Input-Output method . . . . .                        | 26         |
| 2.4.4 Instrumental Variable method . . . . .                     | 29         |
| 2.4.5 Two-Step method . . . . .                                  | 31         |
| 2.5 Generalized closed-loop identification method . . . . .      | 33         |
| 2.6 Conclusions . . . . .  | 36         |
| <b>3 Parametrization aspects</b>                                 | <b>39</b>  |
| 3.1 Introduction . . . . .                                       | 39         |
| 3.2 Dead-time estimation . . . . .                               | 40         |
| 3.3 Orthogonal FIR parametrization . . . . .                     | 41         |
| 3.4 MIMO model structure selection . . . . .                     | 43         |
| 3.4.1 Uniquely identifiable parametrizations . . . . .           | 43         |
| 3.4.2 Model structure selection procedure . . . . .              | 45         |
| 3.4.3 Simulation example . . . . .                               | 49         |

|          |   |            |
|----------|---|------------|
| 3.5      | Lattice algorithms for on-line SISO identification . . . . .          | 51         |
| 3.5.1    | Introduction . . . . .  | 51         |
| 3.5.2    | Recursive identification . . . . .                                    | 52         |
| 3.5.3    | Orthogonalization of the regressor space . . . . .                    | 56         |
| 3.5.4    | General lattice algorithms . . . . .                                  | 60         |
| 3.5.5    | Simplified lattice algorithms for specific parametrizations . . . . . | 61         |
| 3.5.6    | Convergence of LELS . . . . .   | 64         |
| 3.5.7    | Simulation results . . . . .  | 69         |
| 3.5.8    | On-line closed-loop identification . . . . .                          | 71         |
| 3.6      | Conclusions . . . . .   | 72         |
| <b>4</b> | <b>Control-relevant identification</b>                                | <b>75</b>  |
| 4.1      | Introduction . . . . .  | 75         |
| 4.2      | Iterative identification and controller design . . . . .              | 76         |
| 4.3      | The Zang scheme for LQ control design . . . . .                       | 79         |
| 4.4      | Improved identification in the Zang scheme . . . . .                  | 81         |
| 4.5      | Extended iterative scheme . . . . .                                   | 85         |
| 4.6      | When to stop the iteration . . . . .                                  | 87         |
| 4.7      | Conclusions . . . . .   | 88         |
| <b>5</b> | <b>Input design and model validation</b>                              | <b>91</b>  |
| 5.1      | Introduction . . . . .  | 91         |
| 5.2      | The use of the Hessian for input design . . . . .                     | 94         |
| 5.3      | Input protocols . . . . .   | 101        |
| 5.3.1    | Multisine . . . . .   | 101        |
| 5.3.2    | Filtered white noise . . . . .  | 102        |
| 5.3.3    | Generalized Binary Noise (GBN) . . . . .                              | 102        |
| 5.4      | Optimal input design for parameter variance reduction . . . . .       | 104        |
| 5.5      | Input design for frequency function variance reduction . . . . .      | 105        |
| 5.5.1    | Derivation of the Hessian . . . . .                                   | 106        |
| 5.5.2    | FIR input design example . . . . .                                    | 109        |
| 5.5.3    | OE input design example . . . . .                                     | 115        |
| 5.6      | Closed-loop frequency-domain design . . . . .                         | 117        |
| 5.7      | Choice of weighting functions . . . . .                               | 120        |
| 5.8      | Closed-loop excitation considerations . . . . .                       | 122        |
| 5.9      | Model validation . . . . .  | 125        |
| 5.10     | Conclusions . . . . .   | 127        |
| <b>6</b> | <b>Distillation column experiment</b>                                 | <b>129</b> |
| 6.1      | Introduction . . . . .  | 129        |
| 6.2      | Process description . . . . .   | 130        |



---

|          |   |            |
|----------|---|------------|
| 6.3      | Experiment design . . . . .   | 133        |
| 6.4      | Identification results . . . . .                                    | 137        |
| 6.4.1    | Data preprocessing . . . . .  | 137        |
| 6.4.2    | Dead-time estimation . . . . .                                      | 140        |
| 6.4.3    | Identified models . . . . .   | 140        |
| 6.4.4    | Discussion . . . . .  | 153        |
| 6.5      | Conclusions . . . . .   | 154        |
| <b>7</b> | <b>Conclusions</b>  | <b>157</b> |
| 7.1      | Contributions of the thesis . . . . .                               | 157        |
| 7.2      | Recommendations for future research . . . . .                       | 159        |
| <b>A</b> | <b>Matrix calculus</b>  | <b>161</b> |
| A.1      | Matrix definitions . . . . .  | 161        |
| A.2      | Matrix calculus . . . . .   | 162        |
| A.3      | Matrix Inversion Lemma . . . . .                                    | 163        |
| A.4      | Two-norm . . . . .  | 163        |
|          | <b>Literature</b>   | <b>165</b> |
|          | <b>List of symbols and abbreviations</b>                            | <b>177</b> |
|          | <b>Gesloten-lus identificatie onderwerpen in de procesindustrie</b> | <b>183</b> |
|          | <b>Acknowledgements</b>   | <b>187</b> |
|          | <b>Curriculum Vitae</b>   | <b>189</b> |
|          | <b>Index</b>  | <b>191</b> |



# *Chapter 1*

---

## *Introduction*

### *1.1 Identification and control in the process industry*

A production site in the process industry consists of many production units (process plants), each of which contains a large number of complex unit operations (e.g., distillation columns, reactors, compressors). These unit operations – or processes, as they are called in the control literature – are required to produce semimanufactured or finished products, according to predefined specifications. To meet these specifications, a control system is required to deal with uncertainties in the process behavior, such as changing outside temperature or uncertain composition of raw material.

The control system is often set up in a hierarchical structure. A number of low-level controllers control flows, pressures, temperatures and the like. Typically these are local controllers, often of the PID type, connected to, e.g., valves. The initial tuning of the controllers is usually done by means of simulation. Fine tuning is done on line.

A higher level of controllers determines the set points of the low-level controllers. These controllers handle a complete unit operation. They are multivariable (Multiple-Inputs-Multiple-Outputs, MIMO) in general. To control the uncertainties in the process, these controllers need more knowledge of the process behavior than the low-level controllers. Therefore they are usually based on a model that describes the process behavior.

The controllers are tuned in accordance with some performance specifications, such as the quality of the output product. Taking a distillation column as an example, one could think of the purity of the distillate as a measure of quality. Note that quality must be measurable, otherwise it cannot be evaluated by a controller.

There might be a still higher level of controllers, to optimize the overall production performance of a complete plant, or a subdivision thereof. These controllers are typically used to plan and schedule production over the entire production plant. They take into account, for example, the orders, the average time a product spends in the different units, and the costs of raw material, energy and labor.

Currently, a lot of effort is being put into improving the performance of production plants. Economic and environmental constraints impose more stringent demands on productivity, efficiency and flexibility. Higher quality standards are demanded, at lower cost and with less harmful emission. As a consequence of all this, control theory has become increasingly important, in order to provide still better and more sophisticated controllers, which in turn requires more from (experimental) modeling.

The achievable control performance is limited by the process characteristics (e.g., non-minimum phase behavior), the control strategy (PID, predictive, adaptive, etc.) and, in the case of model-based controllers, by the quality of the model on which the controller is based.

This model is a mathematical model that in some sense describes the dynamic behavior of the plant to be controlled. It is intuitively clear that if a controller is based on a model that does not describe a process well, the control performance that can be achieved is lower than if it is based on a model that is a better description of the process. This motivates the interest in modeling dynamical systems.

We distinguish several types of mathematical models: white-box, black-box and gray-box models.

A white-box model is built proceeding from knowledge of the physical properties of the process. Through laws of conservation (mass, energy, etc.), the equations are derived that describe the behavior of the process. Accurate knowledge of the process is required, and generally these models are complex and detailed.

A black-box model is built from data records, which consist of samples of the process inputs and outputs. A mathematical relation is conjectured between these inputs and outputs, and the parameters that determine this relationship are estimated from the data records, using e.g. Prediction Error Methods (Ljung, 1987). This procedure is often called *identification*. In general, the model parameters have no physical meaning.

A gray-box model is built from data records as well, but some prior knowledge is included in the identification phase. Typically, prior knowledge is concerned with specific regions in which the parameter values lie, or with a physical interpretation of the model structure.

Black-box models are suited for controller design, because control design techniques generally require a mathematical model, only describing the input-output behavior of a process (Åström and Wittenmark, 1989; Morari and Zafriou, 1989). There is no need for physical interpretation of these models. Therefore, we investigate the possibility to obtain black-box models from data records. The intended model application is the improvement or redesign of model-based controllers.

A general setup of a closed-loop configuration is schematically shown in Figure 1.1. The arrows indicate a flow of information. The plant behavior is influenced by a control signal that is generated by a controller, and by all kinds of disturbances, such as the outside temperature or the composition of raw material.

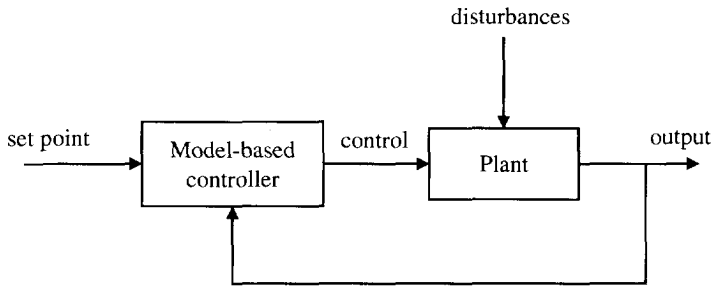

Figure 1.1. General setup of a plant with a model-based controller

The plant output is the variable that needs to be controlled, such as the quality of the product. The output is measured and fed back to the controller. There it is compared with a given set point, specifying the desired value of the output. Based on the difference between plant output and set point, and a model of the plant, a new control signal is calculated. This is then applied to the plant.

As stated before, the model on which a controller is based, is obtained with identification, from a data set of input and output measurements. To obtain these data sets, experiments must be carried out. An experiment usually consists of injecting a test signal at the plant input, and observing the effect at the plant output. The test signal must be designed to excite the plant dynamics, in order for them to become apparent in the data set. An identification procedure combines the data in the data set to build a model.

To be applicable, the experiment and the identification procedure must take into account the characteristics of the process industry:

1. processes are multivariable (MIMO);
2. processes are complex and of high order;
3. there can be long time delays in the processes;
4. processes are nonlinear, but their behavior can often be linearized around an operating point;
5. processes are relatively slow compared to changing external conditions (weather, raw material quality);
6. experiments are expensive;
7. experiments cannot be carried out in open loop, as opposed to what is assumed in much of the identification literature (e.g., Ljung, 1987; Söderström and Stoica, 1989).

The first three items imply that an identification procedure should be capable of identifying complex multivariable models with large time delays. These models can be linear in general, as indicated by the fourth item.

The fifth point mentioned implies that changing external conditions can influence the operating point, and hence the plant's behavior. Since a model should describe this plant's behavior, the behavior should not change during an experiment. The experiment length is therefore limited.

Experiments are expensive (sixth item) because a test signal always causes a quality deterioration. Consequently, the number of experiments that can be done is limited, for economic reasons.

The seventh item has to do with both economic and safety reasons. First of all, if a plant is open-loop unstable it is impossible to do an open-loop experiment without damage to the plant and its environment. But even if the plant is open-loop stable, a controller must stay active during an experiment to react to disturbances. Only this can guarantee the safety of the plant and its environment. Finally, if the plant is not controlled the output will generally not satisfy the quality demands, thus resulting in a loss of production and high experimental costs.

It is frequently considered a disadvantage that the controller must stay active during the experiment, for the controller counteracts the test signal. The advantage of closed-loop experiments, however, is that the data is obtained during normal operation, and hence the process is more likely to be at, and stay in, its operating point. The model is then valid for normal operating conditions.

The implications of the closed-loop operation for system identification are dealt with in a later chapter.

## 1.2 Problem formulation

As stated in the previous section, we want to find a model of the plant shown in Figure 1.1 with which the model-based controller can be improved or redesigned. To arrive at a more precise problem formulation, we define the elements of Figure 1.1 in a more control-theoretical way. The loop can be reshaped into the block diagram shown in Figure 1.2. It is assumed that the plant can be described by a Linear Time-Invariant Finite-Dimensional (LTIFD) proper transfer function matrix  $G_0(z)$ , which is not necessarily BIBO stable<sup>1</sup>. The number of plant inputs is  $m$ , and the number of plant outputs is  $p$ . The input vector is  $u_t \in \mathbb{R}^m$ , and the output vector is  $y_t \in \mathbb{R}^p$ . Hence  $G_0 \in \mathbb{R}^{p \times m}(z)$ , the field of rational functions of  $z \in \mathbb{C}$ , with real coefficients.

In general, we use the argument  $z \in \mathbb{C}$  for transfer function matrices. The argument is

<sup>1</sup>In this thesis only the BIBO stability of systems is considered

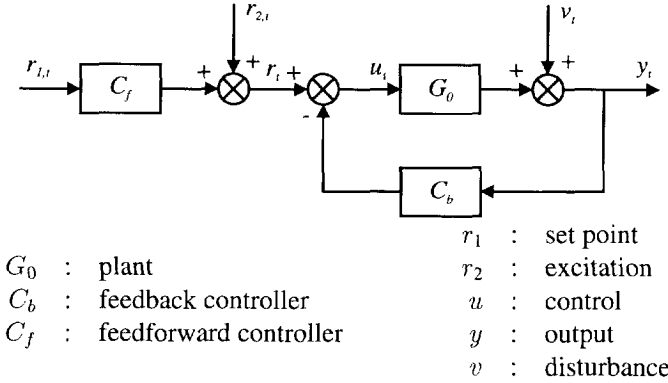

Figure 1.2. Block diagram of the production unit shown in Figure 1.1

replaced by  $q$ , the forward shift operator ( $qu_t = u_{t+1}$ ), if we use the transfer function matrices as a mapping from an input time vector to an output time vector. The frequency function of  $G_0$  is denoted by  $G_0(e^{i\omega})$ , where  $z$  has been substituted by  $e^{i\omega}$ . For readability, the argument is omitted if it is clear from the context whether we mean  $z$ ,  $q$  or  $e^{i\omega}$ .

The controller is assumed to consist of two parts: a feedforward part  $C_f \in \mathbb{R}^{m \times p}(z)$  and a feedback part  $C_b \in \mathbb{R}^{m \times p}(z)$ .

The set point or reference signal is denoted by  $r_{1,t} \in \mathbb{R}^p$ .  $r_{2,t} \in \mathbb{R}^m$  is an external input signal, which can be used for identification purposes, and which might or might not be present. The vector  $r_t \in \mathbb{R}^m$  is the combination of  $r_{1,t}$  and  $r_{2,t}$ :

$$r_t = C_f(q)r_{1,t} + r_{2,t}. \quad (1.1)$$

The disturbances are all lumped into  $v_t \in \mathbb{R}^p$ . All signals are assumed to be quasi-stationary, and it is assumed that  $v$  and  $r$  are uncorrelated:

$$\bar{\mathbb{E}}\{(r_t - \bar{\mathbb{E}}\{r_t\})(v_{t-\tau} - \bar{\mathbb{E}}\{v_{t-\tau}\})\} = 0 \quad \forall \tau \in \mathbb{Z} \quad (1.2)$$

where  $\bar{\mathbb{E}}$  is the *generalized expectation operator* (Ljung, 1987), defined by

$$\bar{\mathbb{E}}\{x_t\} = \lim_{N \rightarrow \infty} \frac{1}{N} \sum_{t=1}^N \mathbb{E}\{x_t\} \quad (1.3)$$

with  $\mathbb{E}$  the standard expectation operator, and  $x$  a quasi-stationary signal.

Using  $\bar{\mathbb{E}}$  instead of  $\mathbb{E}$  ensures that all definitions of stochastic quantities (e.g., covariance,

spectrum) apply to both stochastic and deterministic signals, as long as they are quasi-stationary.

The problem discussed in this thesis can be formulated as: can we obtain a model  $\hat{G}$  of the plant  $G_0$  shown in Figure 1.2, with which the control performance can be enhanced through redesign of  $C_f$  and  $C_b$ , while taking into account the specific characteristics of the process industry, mentioned on page 3?

This problem statement covers a broad area of research, since there are many aspects that influence the identification result. Only some of these aspects are discussed.

The fact that the models are identified from closed-loop data must be taken into account explicitly. Application of standard open-loop identification techniques, such as the Prediction Error Method (Ljung, 1987), to closed-loop data can cause problems that do not occur with open-loop data (Gustavsson *et al.*, 1977, 1981; Söderström and Stoica, 1989). Several methods have been presented in literature to identify a model from closed-loop data. Many of these have the underlying assumption that the model can describe the process exactly. Under this assumption, asymptotic properties of closed-loop identification methods have been investigated, and many of these methods were found to give consistent results (Gustavsson *et al.*, 1977, 1981).

However, recent developments in approximate modeling (e.g., Wahlberg and Ljung, 1986; Van den Hof and Jansen, 1987; Schrama, 1992a) have raised the issue of *bias*. It is realized that a model can never describe a process exactly, and that there will always be a model mismatch (bias). The closed-loop identification problem can then be formulated not in terms of the possibility to obtain an unbiased estimate, but in terms of the possibility to explicitly control the bias distribution, in order to include control design aspects in the identification procedure. A closed-loop identification procedure that provides this explicit control is Van den Hof and Schrama's Two-Step method (1992, 1993).

Another issue that determines the result of identification is the parametrization. Since black-box models are estimated, there is no physical interpretation of the parametrization. It is an additional freedom, which should be used with care.

Particular problems involve the selection of a model structure for multivariable systems, and dead time estimation. For on-line identification, lattice algorithms (Morf *et al.*, 1977, 1978, 1979; Ljung and Söderström, 1983) are of special interest. A change of parametrization provides numerically robust algorithms. However, currently these algorithms exist for simple parametrizations only, and an extension toward more general model structures is needed.

Only recently *control-relevant identification* has emerged as an important research topic. Identification of a process is never a goal in itself. There is always an intended model application. In general this is either the better understanding of the process behavior, or the design of a controller with which the process behavior can be influenced. Both model applications have different requirements for the model.



It can be argued that a specific controller has specific needs regarding, e.g., the accuracy of a model in a certain frequency band. This design aspect should be taken into account in the identification procedure, and to do this it is necessary to have explicit control over the distribution of the model error. The identification procedure then reflects the intended model application of control design.

Several schemes of iterative identification and controller design have been developed. Examples are those proposed by Bitmead and Zang (1991), Zang *et al.* (1991), Schrama (1992a/b), Shook *et al.* (1992), Gevers (1993), Åström (1993) and Van den Hof and Schrama (1994). However, to date, no general results are known regarding the convergence of the iteration. Moreover, these schemes require each designed controller to be implemented, which can result in a large number of experiments. Since the experiments in the process industry are expensive, a strategy must be found to avoid this.

Another aspect that determines the identification result is the test signal that is used to excite the system. On the one hand, this signal should be designed so that there is only a small model uncertainty. This can be achieved by extracting a maximum amount of information about the important dynamics from the process. On the other hand, this signal should not deteriorate the process operation too much, because that would increase the experiment cost. Hence we have a classical trade-off, which suggests the use of optimization methods to design an input signal. The model uncertainty can then be distributed according to, e.g., control design specifications.

Depending on the aim of the modeler, there are two possible approaches to input design. Mehra's approach (1974, 1981) is aimed at reducing the uncertainty or variance of the estimated parameters without taking into account subsequent control design. However, since performance properties generally depend on frequency function characteristics (e.g., robustness margins), an input design method that considers the uncertainty of the frequency function seems more appropriate, if controller design is the intended model application. Yuan and Ljung (1984) and Gevers and Ljung (1986) propose such a method, but they assume that the model order tends to infinity. For finite order models, an input design method needs to be developed, both for open-loop and for closed-loop identification.

The evaluation of the identification result is done by model validation. Although classically the quality of a model is determined by how well it describes the process behavior, the ultimate validation in the view of controller design is the achieved performance of the designed controller.

## 1.3 Outline

This thesis is divided into 7 chapters dealing with the various issues raised in the previous section.

Chapter 2 addresses the problem of closed-loop identification. Desired characteristics of a closed-loop identification method are formulated, and they are compared to those of existing methods. A method is proposed that generalizes many closed-loop identification methods. Special attention is paid to approximate identification, and to the problem of influencing the bias of the approximate model in an explicit way, so as to incorporate specific knowledge of the controller design phase in the identification phase.

In Chapter 3, the parametrization problem is discussed. Dead-time estimation and a parametrization based on orthonormal basis functions are discussed as state-of-the-art solutions. A simple but effective procedure is proposed to select a suitable model structure for multivariable models. Finally, existing lattice algorithms for on-line identification, which can only handle simple parametrizations, are extended toward more general model structures for SISO models.

In Chapter 4, we address the problem of control-relevant identification: can the identification step be done in such a way that the construction of a model is directed toward the design of a better controller? An extension to existing iterative schemes of identification and controller design is proposed, with which the number of experiments needed can be reduced.

In Chapter 5, a solution to the input design problem for finite-dimensional models is proposed. The approach that we take is related to *global identification* (Richalet, 1991), which estimates both a model and an uncertainty interval around it. The proposed procedures aim at reshaping, and possibly reducing, this uncertainty interval. The model validation problem is touched upon, but not solved.

To put into practice the insights, gained in Chapters 2 to 5, an industrial case is studied in Chapter 6. A distillation column is identified from closed-loop data, and some conclusions can be drawn regarding the usefulness of the developed techniques.

Chapter 7 presents the conclusions of the thesis, and some recommendations for future research.

# Chapter 2

---

## Closed-loop identification

This chapter deals with the problem of finding a model  $\hat{G}$  of  $G_0$  in the configuration shown in Figure 1.2, given the measurements of  $y$ , and  $u$ , and  $r$  if present.

First some general remarks are made on open-loop identification. Having set notation and definitions, the closed-loop identification problem can be stated more formally in Section 2.2. Requirements are formulated for closed-loop identification methods, and in Section 2.4 several methods are analyzed to check whether they fulfill these requirements. Finally, in Section 2.5 a closed-loop identification method is proposed that unifies most of the known methods, and that satisfies the formulated requirements.

### 2.1 Open-loop identification

In open-loop identification it is assumed that the plant to be identified can be described as depicted in Figure 2.1. The input-output behavior is denoted by  $G_0 \in \mathbb{R}^{p \times m}(z)$ , and the

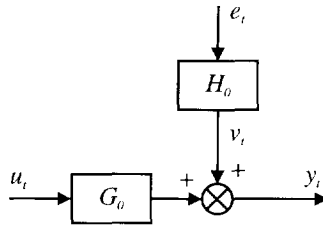

Figure 2.1. Open-loop system configuration

noise behavior is denoted by  $H_0 \in \mathbb{R}^{p \times p}(z)$ . It is assumed that  $G_0$  is LTIFD and BIBO stable, and that  $H_0$  is LTIFD, BIBO stable and inversely BIBO stable (remember that only BIBO stability is considered).

The process input is denoted by  $u_t \in \mathbb{R}^m$ , and the process output is denoted by  $y_t \in \mathbb{R}^p$ . Both  $y$  and  $u$  are measurable, and a data set of  $N$  samples of  $y$  and  $u$  is denoted as  $\{y_t, u_t\}_N$ .

The disturbances, denoted by  $v_t \in \mathbb{R}^p$ , are lumped to the output and are assumed to have rational spectral density. The sequence  $\{e_t \in \mathbb{R}^p\}$  is a Zero Mean White Noise (ZMWN) sequence.

All signals are quasi-stationary, and are assumed to have zero mean. Moreover, it is assumed that  $u$  and  $e$  are uncorrelated:  $\bar{\mathbb{E}}\{u_t e_{t-\tau}\} = 0$  for all  $\tau \in \mathbb{Z}$ .

By definition, the collection  $(G_0(z), H_0(z))$  is called the *system*, denoted by  $\mathcal{S}$ .

A model of  $\mathcal{S}$  describes the dynamical relationship between the measured  $u_t$  and  $y_t$ , and can therefore be viewed as a compact description of the data set. Hence, identification can be seen as *data reduction*. To extract enough information about the dynamics of the system from the data set, the input signal needs to be sufficiently rich or *persistently exciting* (Ljung, 1987).

There are two possible open-loop identification problems:

1. Given  $\{y_t, u_t\}_N$ , how can we find a model  $\hat{G}$  of  $G_0$ ?
2. Given  $\{y_t, u_t\}_N$ , how can we find a model  $(\hat{G}, \hat{H})$  of  $(G_0, H_0)$ ?

Clearly, the second problem is harder to solve. Depending on the intended model application, one or the other of these questions has to be answered.

There are several approaches to tackling the open-loop identification problem. They can be divided into two categories:

1. nonparametric identification methods
2. parametric identification methods.

Both cases are dealt with subsequently.

### 2.1.1 Nonparametric identification

A nonparametric identification method provides a model of  $G_0$  only. No parametrized structure in the model is assumed, and there is only a small data reduction. Consequently, the variance of the estimate is high. Windowing techniques are usually applied to smooth the estimate, at the cost of introducing a bias.

We mention *spectral analysis* (Priestley, 1981) as an example of nonparametric identification, by which method an estimate of  $G_0$  is obtained in the frequency domain. The amplitude and the phase of the frequency response (matrix) are calculated for a finite number of frequencies.

Spectral analysis is based on the relation between the cross-spectrum of input and output,  $\Phi_{yu}(\omega)$ , and the input spectrum  $\Phi_u(\omega)$ . Since  $e$  and  $u$  are assumed to be uncorrelated,  $v$  and  $u$  are uncorrelated, and hence  $\Phi_{vu}(\omega) = 0$ . We have

$$\Phi_{yu}(\omega) = G_0(e^{i\omega})\Phi_u(\omega) \Leftrightarrow G_0(e^{i\omega}) = \Phi_{yu}(\omega)\Phi_u^{-1}(\omega) \quad (2.1)$$

where the latter equation, of course, only holds if  $\Phi_u(\omega)$  is invertible, requiring a sufficiently rich (persistently exciting) input signal.

If  $\Phi_{yu}(\omega)$  and  $\Phi_u(\omega)$  are estimated from data, an estimate  $\hat{G}_N$  of  $G_0$  is

$$\hat{G}_N(e^{i\omega}) = \hat{\Phi}_{yu,N}(\omega)\hat{\Phi}_{u,N}^{-1}(\omega) \quad (2.2)$$

where the hat  $\hat{\cdot}$  denotes that the values are estimated from data. The subscript  $N$  shows the dependence on the number of data,  $N$ .

Under weak conditions (Priestley, 1981) it is possible to obtain consistent estimates of the spectra  $\Phi_u$  and  $\Phi_{yu}$ :

$$\lim_{N \rightarrow \infty} \hat{\Phi}_{u,N}(\omega) = \Phi_u(\omega) \quad \text{w.p. 1} \quad (2.3a)$$

$$\lim_{N \rightarrow \infty} \hat{\Phi}_{yu,N}(\omega) = \Phi_{yu}(\omega) \quad \text{w.p. 1} \quad (2.3b)$$

where *w.p. 1* means *with probability one*, and therefore spectral analysis yields a consistent estimate of  $G_0$ :

$$\lim_{N \rightarrow \infty} \hat{G}_N(e^{i\omega}) = G_0(e^{i\omega}) \quad \text{w.p. 1.} \quad (2.4)$$

However, there is no data reduction, for with  $N$  data points,  $N$  parameters are estimated ( $N/2$  amplitudes and  $N/2$  phases). This results in an unbiased estimate with a high variance. Windowing techniques are used to smooth the result, at the cost of the introduction of a bias. Windowing is based on the absence of correlation between the estimates for neighboring frequencies. By using windows, correlation is introduced, and the variance is reduced.

Nonparametric models usually have too high an order to be used for, e.g., control design. However, they serve a good purpose in model validation where a parametric model, on which a controller will be based, can be compared to a nonparametric, unbiased model.

### 2.1.2 Parametric identification

For simulation and control design purposes, usually a low order model is required, with few parameters. The model is then *parametrized* with parameter vector  $\theta$ , where the *parametrization*  $\Pi$  is a mapping from the parameter vector  $\theta$  to the specific model  $(G(z, \theta), H(z, \theta))$ :

$$\Pi : \Theta \mapsto (\mathbb{R}^{p \times m}(z) \times \mathbb{R}^{p \times p}(z)) \quad (2.5)$$

where  $\Theta \subset \mathbb{R}^d$  is the parameter space ( $\theta \in \Theta$ ), or, equivalently

$$\Pi : \theta \mapsto (G(z, \theta), H(z, \theta)). \quad (2.6)$$

If no noise model is determined, this simplifies to

$$\Pi : \theta \mapsto G(z, \theta). \quad (2.7)$$

A parametrization imposes a certain structure on the model. Hence it is also termed a *model structure*. In some cases, physical knowledge might suggest a certain parametrization. However, in black-box identification the model structure has no physical interpretation, and it is determined from the data.

As an example of a black-box SISO parametrization, we mention first order ARX, with a dead time of one sample. The parameter vector and corresponding model are

$$\theta = \begin{pmatrix} a \\ b \end{pmatrix} \xrightarrow{\Pi} (G(z, \theta), H(z, \theta)) = \left( \frac{bz^{-1}}{1 + az^{-1}}, \frac{1}{1 + az^{-1}} \right). \quad (2.8)$$

The choice of a suitable parametrization is nontrivial. In Chapter 3, we discuss the choice of a parametrization for MIMO systems.

A model structure also defines a *model set*, which is the *image* of the parametrization ( $\text{im}(\Pi)$ ). Depending on whether or not a noise model is estimated, we distinguish the model sets  $\mathcal{M}$  and  $\mathcal{G}$ , respectively.

The model set  $\mathcal{M}$  is the set of all possible process and noise models:

$$\mathcal{M} = \text{im}(\Pi) = \{(G(z, \theta), H(z, \theta)) | \theta \in \Theta\}. \quad (2.9)$$

An *independently parametrized* process and noise model have no parameters in common. Such a set is defined as

$$\mathcal{M} = \{(G(z, \theta_g), H(z, \theta_h)) | \theta_g \in \Theta_g, \theta_h \in \Theta_h, \Theta = \Theta_g \times \Theta_h\}. \quad (2.10)$$

The model set  $\mathcal{G}$  is the set of all possible process models:

$$\mathcal{G} = \{G(z, \theta) | \theta \in \Theta\}. \quad (2.11)$$

In this case, the noise model is kept constant (e.g.,  $I_p$  in the case of an OE parametrization, with  $I_p$  the  $p \times p$  identity matrix).

Once a parametrization has been chosen, a parametric identification method can provide a parameter estimate  $\hat{\theta}_N$  from a data set of length  $N$ . The corresponding model with parameter vector  $\hat{\theta}_N$  is denoted by  $(G(\hat{\theta}_N), H(\hat{\theta}_N))$ , or simply by  $(\hat{G}, \hat{H})$ .

Suppose that there is a *true* parameter vector  $\theta_0$ , such that  $G(\theta_0, z) = G_0(z)$  and  $H(\theta_0, z) = H_0(z)$  for almost all  $z$ . In this case we have that  $\mathcal{S} \in \mathcal{M}$ . Note that

$$\mathcal{S} \in \mathcal{M} \Rightarrow G_0 \in \mathcal{G}. \quad (2.12)$$

The converse, however, is not true.

Of course, if  $\mathcal{S} \in \mathcal{M}$ , we want an identification method or *estimator* to provide us with the estimate  $\hat{\theta}_N = \theta_0$ , at least if  $N \rightarrow \infty$ . This is an asymptotic property of estimators, termed *consistency*:

**Definition 2.1** *An estimator is consistent if*

$$\lim_{N \rightarrow \infty} \hat{\theta}_N = \theta_0 \quad w.p. 1. \quad (2.13)$$

If an estimator is consistent,  $(\hat{G}, \hat{H})$  tends to  $(G_0, H_0)$ , asymptotically.

Of course,  $\mathcal{S} \in \mathcal{M}$  does not occur in practice, but it gives the opportunity to analyze the asymptotic properties of estimators.

In the remaining part of this section we discuss two parametric identification methods:

1. The Prediction Error Method (PEM), which is described by, among others, Ljung (1987), Söderström and Stoica (1989), and Van den Bosch and Van der Klauw (1994);

2. The Instrumental Variable method (IV), which is described by, among others, Söderström and Stoica (1983).

Of course, there are other open-loop identification methods, such as Subspace Model Identification (SMI) (Moonen *et al.*, 1989; Moonen and Vandewalle, 1990; Van Overschee and De Moor, 1991, 1993, 1994a/b; Verhaegen and Dewilde, 1992a/b). Although SMI is a very promising identification technique, it is still in development. There are not as many analysis results available yet as for PEM and IV. For example, for PEM and IV asymptotic expressions can be derived, showing the bias distribution of the models. For approximate modeling, these expressions give insight into the influence of different choices of design variables on the final model.

For SMI these approximation criteria are not available, mainly because the algorithms cannot be rewritten as one optimization problem. Research is still going on to interpret the SMI algorithms and their properties, and to develop the methods further (Van Overschee and De Moor, 1994a/b). For these reasons SMI is not considered in this research.

The following short descriptions of PEM and IV are provided to define notation, and merely summarize what can be found in the literature mentioned above. It is assumed that the data set  $\{y_t, u_t\}_N$  is obtained in an open-loop situation, as depicted in Figure 2.1.

### **Prediction Error Method**

The Prediction Error Method (PEM) is based on the assumption that a model  $(\hat{G}, \hat{H})$  predicts the behavior of the system  $(G_0, H_0)$ . Consequently, the one-step-ahead prediction  $\hat{y}_t$  depends on  $(\hat{G}, \hat{H})$ . It is defined as the conditional expectation of  $y_t$ , given measurements of input and output signals up to and including time instant  $t - 1$ :

$$\hat{y}_t = \bar{\mathbb{E}}\{y_t | y_{t-1}, u_{t-1}, y_{t-2}, u_{t-2}, \dots\}. \quad (2.14)$$

Given a model structure  $\mathcal{M}$  with parameter vector  $\theta$ ,  $\hat{y}_t = \hat{y}_t(\theta)$  is given by (see, e.g., Ljung, 1987)

$$\hat{y}_t(\theta) = H^{-1}(q, \theta)G(q, \theta)u_t + [I_p - H^{-1}(q, \theta)]y_t. \quad (2.15)$$

This can be written in regression form (Ljung, 1987) as

$$\hat{y}_t(\theta) = \phi'_t(\theta)\theta \quad (2.16)$$



where  $'$  denotes the transpose of a matrix, and where  $\phi_t$  is the *regression matrix*, containing past values of  $y$  and  $u$ , and filtered versions thereof that depend on  $\theta$ .

For linear parametrizations (FIR, ARX),  $\phi$  is independent of  $\theta$ .

The prediction error  $\varepsilon_t(\theta)$  of a model  $(G(\theta), H(\theta))$  is defined as

$$\varepsilon_t(\theta) = y_t - \hat{y}_t(\theta) = H^{-1}(q, \theta)[y_t - G(q, \theta)u_t]. \quad (2.17)$$

Note that, for a linear parametrization,  $\phi_t$  is equal to the negative gradient of  $\varepsilon_t$ :

$$\phi_t = - \left[ \frac{\partial \varepsilon_t(\theta)}{\partial \theta} \right]'. \quad (2.18)$$

A parameter estimate  $\hat{\theta}_N$  is found by minimizing a function of the prediction error, usually the sum of squares of a filtered version of the prediction error,  $\varepsilon_{L,t}(\theta)$ :

$$\varepsilon_{L,t}(\theta) = L(q)\varepsilon_t(\theta) \quad (2.19)$$

with  $L \in \mathbb{R}^{p \times p}(z)$  a stable LTIFD filter.

Hence

$$\hat{\theta}_N = \arg \min_{\theta \in \Theta} V_N(\theta) \quad (2.20a)$$

$$V_N(\theta) = \frac{1}{N} \sum_{t=1}^N \varepsilon'_{L,t}(\theta) \varepsilon_{L,t}(\theta) = \text{tr} \frac{1}{N} \sum_{t=1}^N \varepsilon_{L,t}(\theta) \varepsilon'_{L,t}(\theta) \quad (2.20b)$$

where  $\text{tr}$  denotes the trace of a matrix, and  $V_N$  is the *identification criterion*.

For analysis purposes (e.g. consistency), we need some asymptotic expressions, showing what happens with the models when the number of data tends to infinity. In this case  $N \rightarrow \infty$  and  $1/N \sum_{t=1}^N \rightarrow \bar{\mathbb{E}}$  in (2.20b). It can be shown (Ljung, 1985; 1987) that asymptotically, under weak conditions, the loss function  $V_N(\theta)$  in (2.20b) tends uniformly to the limit function  $V_\infty(\theta)$ , with probability one:

$$V_\infty(\theta) = \frac{1}{2\pi} \text{tr} \int_{-\pi}^{\pi} LH^{-1}(\theta) \{ [G_0 - G(\theta)] \Phi_u [G_0 - G(\theta)]^* + \Phi_v \} \cdot \{ LH^{-1}(\theta) \}^* d\omega \quad (2.21)$$

where  $*$  denotes the conjugate transpose of a complex matrix.

This can be rewritten using the two-norm  $\|\cdot\|_2$  (see Appendix A) and the fact that  $\Phi_v = H_0\Phi_e H_0^*$  as

$$\begin{aligned} V_\infty(\theta) &= \left\| LH^{-1}(\theta)[G_0 - G(\theta)]\Phi_u^{1/2} \right\|_2^2 + \left\| LH^{-1}(\theta)H_0\Phi_e^{1/2} \right\|_2^2 \\ &= \left\| LH^{-1}(\theta) \begin{bmatrix} [G_0 - G(\theta)]\Phi_u^{1/2} & H_0\Phi_e^{1/2} \end{bmatrix} \right\|_2^2. \end{aligned} \quad (2.22)$$

Because  $V_N(\theta)$  tends to  $V_\infty(\theta)$  uniformly, the minimizing argument of  $V_N(\theta)$ , the parameter estimate  $\hat{\theta}_N$ , tends to the minimizing argument  $\theta_\infty$  of  $V_\infty(\theta)$ :

$$\lim_{N \rightarrow \infty} \hat{\theta}_N = \arg \min_{\theta \in \Theta} V_\infty(\theta) \quad \text{w.p.1} \quad \stackrel{\Delta}{=} \theta_\infty. \quad (2.23)$$

In general,  $\theta_\infty$  is a set, and (2.23) implies convergence into a set, which is to be interpreted as

$$\inf_{\theta \in \theta_\infty} |\hat{\theta}_N - \theta| \rightarrow 0 \quad \text{as } N \rightarrow \infty. \quad (2.24)$$

However, without loss of generality, we will assume  $\theta_\infty$  to consist of only one unique element.

From (2.22) we see that if  $S \in \mathcal{M}$ ,  $V_\infty(\theta_\infty)$  is minimal if  $\theta_\infty = \theta_0$  (implying that  $\hat{G} = G_0$  and  $\hat{H} = H_0$ ). Hence, PEM is a consistent estimator if  $S \in \mathcal{M}$ .

If  $S \notin \mathcal{M}$  but  $G_0 \in \mathcal{G}$ , and  $G$  and  $H$  are independently parametrized,  $V_\infty(\theta_\infty)$  is minimal if  $\hat{G} = G_0$ , irrespective of  $\hat{H}$ . Hence PEM can estimate  $\hat{G}$  consistently if  $G$  and  $H$  are independently parametrized, and  $G_0 \in \mathcal{G}$ . If  $G_0 \notin \mathcal{G}$ , the prefilter  $L$  directly influences the bias distribution through its presence in the frequency weighting.

If, however,  $G$  and  $H$  are not independently parametrized,  $V_\infty(\theta)$  is not necessarily minimal if  $\hat{G} = G_0$ , even if  $G_0 \in \mathcal{G}$ . The second term of (2.22) might have too large a contribution to  $V_\infty$ , and hence  $\hat{G}(\theta_\infty) \neq G_0$  in general. Also, due to the influence of  $\hat{H}$  on  $\hat{G}$ , the influence of the prefilter  $L$  on the bias  $G_0 - \hat{G}$  is less clear.

To summarize this analysis, for independently parametrized  $G$  and  $H$ , the prefilter  $L$  directly influences the bias distribution. Moreover, if  $G_0 \in \mathcal{G}$ , the process can be estimated consistently. Therefore we will only consider independent parametrizations in this thesis.

For linear parametrizations (2.20) simplifies to a Linear Least Squares (LLS) problem.

Suppose that a true parameter  $\theta_0$  exists, such that

$$y_t = \phi_t' \theta_0 + v_{0,t}. \quad (2.25)$$

Then the asymptotic parameter estimate  $\theta_\infty$  is given by (Ljung, 1987; Van den Bosch and Van der Klauw, 1994)

$$\theta_\infty = [\bar{\mathbb{E}}\phi_t\phi_t']^{-1} [\bar{\mathbb{E}}\phi_t\phi_t'\theta_0 + \bar{\mathbb{E}}\phi_tv_{0,t}]. \quad (2.26)$$

This result is only consistent ( $\theta_\infty = \theta_0$ ) if  $\bar{\mathbb{E}}\phi_tv_{0,t} = 0$ , and hence either  $v_0$  should be white noise, or the model must have an FIR structure ( $\phi$  contains  $u$  only). In all other cases, there will be a bias.

### Instrumental Variables

The bias for linear parametrizations in (2.26) can be eliminated by introducing the  $d \times p$ -matrix of *instrumental variables*  $\zeta_t$ . By replacing the gradient  $\phi_t$  by  $\zeta_t$  in (2.26), we obtain

$$\theta_\infty = [\bar{\mathbb{E}}\zeta_t\zeta_t']^{-1} [\bar{\mathbb{E}}\zeta_t\zeta_t'\theta_0 + \bar{\mathbb{E}}\zeta_tv_{0,t}]. \quad (2.27)$$

The requirements for an unbiased estimate are

$$\det \bar{\mathbb{E}}\zeta_t\zeta_t' \neq 0 \quad (2.28a)$$

$$\bar{\mathbb{E}}\zeta_tv_{0,t} = 0. \quad (2.28b)$$

The first requirement indicates that there must be sufficient correlation between  $\zeta$  and  $\phi$ . The second requirement indicates that the instruments must be chosen such that there is no correlation between  $\zeta$  and  $v_0$ .

A reasonable choice of instruments is a matrix of delayed input signals  $u$ . This choice leads to the *Basic IV* (Söderström ad Stoica, 1983).

*Bootstrap IV* (Söderström and Stoica, 1983) is an example of an iterative procedure in which the instruments are generated by a model obtained in a previous step. As an initial estimate, an ARX model is estimated with LLS.

The asymptotic IV estimate  $\theta_\infty$  is solved in the same manner as LLS. From (2.25) and (2.27) we obtain

$$\bar{\mathbb{E}}\{\zeta_t\phi_t'\}\theta_\infty = \bar{\mathbb{E}}\{\zeta_t y_t\} \quad (2.29)$$

and hence

$$\bar{\mathbb{E}}\{\zeta_t [y_t - \phi_t'\theta_\infty]\} = 0 \quad (2.30)$$

or, equivalently,

$$\bar{\mathbb{E}} \{ \zeta_t \varepsilon_t(\theta_\infty) \} = 0. \quad (2.31)$$

Since a linear parametrization is used, we have that

$$\varepsilon_t(\theta) = A(q^{-1}, \theta)y_t - B(q^{-1}, \theta)u_t \quad (2.32)$$

with  $A \in \mathbb{R}^{p \times p}[z^{-1}]$  and  $B \in \mathbb{R}^{p \times m}[z^{-1}]$ , where  $\mathbb{R}^{p \times m}[z^{-1}]$  is the ring of  $p \times m$  polynomial matrices in  $z^{-1}$ . Clearly,  $G(z, \theta) = A^{-1}(z^{-1}, \theta)B(z^{-1}, \theta)$ .

Hence we can rewrite (2.31) and (2.32) as

$$\theta_\infty = \underset{\theta}{\text{sol}} \{ f_{I, \infty}(\theta) = 0 \} \quad (2.33a)$$

$$f_{I, \infty}(\theta) = \bar{\mathbb{E}} \left\{ \zeta_t \left[ A(q^{-1}, \theta)y_t - B(q^{-1}, \theta)u_t \right] \right\}. \quad (2.33b)$$

It can be shown, using Parseval's relationship, that the function  $f_{I, \infty}(\theta)$  in (2.33b) is equivalent to

$$f_{I, \infty}(\theta) = \frac{1}{2\pi} \int_{-\pi}^{\pi} K_u(e^{i\omega}) \Phi_u(\omega) \cdot \left[ A(e^{i\omega}, \theta) \{ G_0(e^{i\omega}) - G(e^{i\omega}, \theta) \} \right]^* d\omega \quad (2.34)$$

where  $K_u \in \mathbb{R}^{p \times d \times m}(z)$  is a tensor of transfer functions, and where the  $j$ th column of  $\zeta_t$  is given by

$$\zeta_t^{(j)} = K_u^{(j)}(q)u_t \quad (2.35)$$

with  $K_u^{(j)} \in \mathbb{R}^{d \times m}(z)$ .

See Appendix A for more information on tensor calculus.

For Basic IV,  $K_u$  consists of delay operators. For Bootstrap IV,  $K_u$  depends on a previously determined model.

From (2.34) it is clear that an asymptotically unbiased estimate  $\hat{G}$  can be obtained from open-loop experiments.

Given an IV variant, the particular choice of the instruments can be formulated as an optimization problem. A scalar function of the covariance matrix of the parameter estimate can be minimized with respect to the instruments, thus resulting in an *Optimal IV* estimator (Söderström and Stoica, 1983).

## 2.2 Closed-loop identification problem

In this section the closed-loop identification problem is stated more precisely.

Again, consider the closed-loop configuration shown in Figure 1.2, which is redrawn in Figure 2.2 for convenience. It is assumed that either  $r_{1,t}$  or  $r_{2,t}$ , or both, are present and

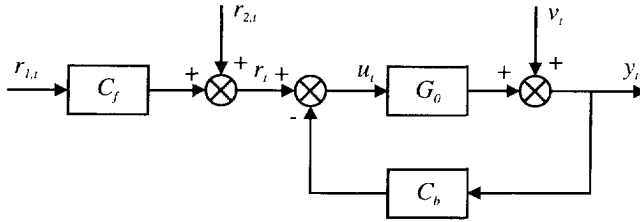

Figure 2.2. Closed-loop control configuration

measurable. Moreover,  $y_t$  and  $u_t$  are measurable.

The closed-loop identification problem is to estimate a model  $\hat{G}$  of  $G_0$  from the data set  $\{y_t, u_t\}_N$ , and possible measurements of  $r_{1,t}$  and  $r_{2,t}$ .

There are several requirements that the identification method has to fulfill.

**Requirement 2.2** A closed-loop identification method that estimates a model  $\hat{G}$  of  $G_0$  must have the following properties:

1. If  $G_0 \in \mathcal{G}$ , but  $\mathcal{S} \not\subseteq \mathcal{M}$ , the estimate  $\hat{G}$  must be consistent;
2. The model must be of low order, and hence it only approximates the real plant;
3. It should be possible to incorporate control design specifications into the identification procedure, if  $\hat{G}(z) \neq G_0(z)$ .

There are several standard assumptions which we make in this chapter.

**Assumption 2.3** It is assumed that

- The data set  $\{y_t, u_t\}_N$  is given and  $r_1$  and/or  $r_2$  are applied and measured, and are sufficiently exciting.

- *There is no algebraic loop in the system (Gustavsson et al., 1977, 1981; Van den Hof et al., 1992), which is guaranteed by*

$$G_0(\infty)C_b(\infty) = \mathbf{0}_{p \times p} \quad (2.36a)$$

$$C_b(\infty)G_0(\infty) = \mathbf{0}_{m \times m} \quad (2.36b)$$

with  $\mathbf{0}_{i \times j}$  the  $i \times j$  matrix of zeroes.

For SISO systems this comes down to a delay in either  $G_0$  or  $C_b$ , or, in other words, that either  $G_0$  or  $C_b$  must be strictly proper.

- *The closed loop is stable, or, in other words,  $C_b$  stabilizes  $G_0$ .*

It is not necessary for  $C_f$  to be stable. For a PID controller, the decomposition into  $C_f$  and  $C_b$  results in an integrator in both, which is clearly not BIBO stable. Nevertheless, this case can still be handled.

From a theoretical viewpoint we do not need the assumption that  $G_0$  is stable. However, the Prediction Error Method does not yield unstable models, and hence for unstable processes, always a stable approximation is found. The asymptotic expressions still apply, but the estimates are not consistent.

The equations that describe the dynamic behavior of the closed-loop system shown in Figure 2.2, are

$$[I_p + G_0 C_b] y_t = G_0 C_f r_{1,t} + G_0 r_{2,t} + v_t \quad (2.37a)$$

$$[I_m + C_b G_0] u_t = C_f r_{1,t} + r_{2,t} - C_b v_t. \quad (2.37b)$$

The output sensitivity function  $S_0^{(o)} \in \mathbb{R}^{p \times p}(z)$  and the input sensitivity function  $S_0^{(i)} \in \mathbb{R}^{m \times m}(z)$  are introduced:

$$S_0^{(o)} = [I_p + G_0 C_b]^{-1} \quad (2.38a)$$

$$S_0^{(i)} = [I_m + C_b G_0]^{-1}. \quad (2.38b)$$

Note that

$$C_b S_0^{(o)} = S_0^{(i)} C_b \quad ; \quad S_0^{(o)} G_0 = G_0 S_0^{(i)}. \quad (2.39)$$

Hence (2.37) can be written as

$$y_t = S_0^{(o)} G_0 C_f r_{1,t} + S_0^{(o)} G_0 r_{2,t} + S_0^{(o)} v_t$$

$$u_t = S_0^{(i)} C_f r_{1,t} + S_0^{(i)} r_{2,t} - S_0^{(i)} C_b v_t$$

which can be rewritten, using (2.39), as

$$y_t = G_0 S_0^{(i)} C_f r_{1,t} + G_0 S_0^{(i)} r_{2,t} + S_0^{(o)} v_t \quad (2.40a)$$

$$u_t = S_0^{(i)} C_f r_{1,t} + S_0^{(i)} r_{2,t} - C_b S_0^{(o)} v_t \quad (2.40b)$$

or, in matrix form

$$\begin{pmatrix} y_t \\ u_t \end{pmatrix} = \begin{bmatrix} G_0 \\ I_m \end{bmatrix} S_0^{(i)} \begin{bmatrix} C_f & I_p \end{bmatrix} \begin{pmatrix} r_{1,t} \\ r_{2,t} \end{pmatrix} + \begin{bmatrix} I_p \\ -C_b \end{bmatrix} S_0^{(o)} v_t. \quad (2.41)$$

Using the definition of  $r_t$  in (1.1), (2.41) reduces to

$$\begin{pmatrix} y_t \\ u_t \end{pmatrix} = \begin{bmatrix} G_0 \\ I_m \end{bmatrix} S_0^{(i)} r_t + \begin{bmatrix} I_p \\ -C_b \end{bmatrix} S_0^{(o)} v_t. \quad (2.42)$$

The spectrum of  $r_t$ ,  $\Phi_r(\omega)$ , is given by

$$\Phi_r(\omega) = C_f(e^{i\omega})\Phi_{r_1}(\omega)C_f^*(e^{i\omega}) + \Phi_{r_2}(\omega). \quad (2.43)$$

In the following sections, several identification methods that can be used for closed-loop identification are discussed. The asymptotic expressions that characterize the parameter estimates are derived, and the methods are evaluated in view of Requirement 2.2, starting from Assumption 2.3.

## 2.3 Nonparametric identification

As in the open-loop case, a nonparametric model can serve for model validation purposes.

It has been shown, e.g., by Söderström and Stoica (1989) that the direct application to closed-loop data of a nonparametric identification method, which does not assume a causal model structure, does not give satisfactory results. For example, for SISO systems, the application of spectral analysis (2.2) to the closed-loop data set  $\{y_t, u_t\}_N$  results in a model that is a compromise between the real process  $G_0$  and the inverse of the feedback controller,  $-1/C_b$ . In this case the spectral estimate is not consistent.

In this section, we show how to avoid this problem, by making use of the external input signal  $r_t$ . We know that

$$\Phi_{yr}(\omega) = G_0(e^{i\omega})S_0^{(i)}(e^{i\omega})\Phi_r(\omega) \quad (2.44a)$$

$$\Phi_{ur}(\omega) = S_0^{(i)}(e^{i\omega})\Phi_r(\omega) \quad (2.44b)$$

and hence

$$\Phi_{yr}(\omega)\Phi_{ur}^{-1}(\omega) = G_0(e^{i\omega})S_0^{(i)}(e^{i\omega})\Phi_r(\omega)\Phi_r^{-1}(\omega) [S_0^{(i)}(e^{i\omega})]^{-1} = G_0(e^{i\omega}) \quad (2.45)$$

for those frequencies where  $\Phi_r(\omega)$  is invertible.

A spectral estimate  $\hat{G}_N$  can then be obtained as (cf. (2.2))

$$\hat{G}_N(e^{i\omega}) = \hat{\Phi}_{yr,N}(\omega)\hat{\Phi}_{ur,N}^{-1}(\omega). \quad (2.46)$$

Referring to Requirement 2.2, we see that the estimate (2.46) is consistent, since, under weak conditions (Priestley, 1981)

$$\lim_{N \rightarrow \infty} \hat{\Phi}_{yr,N}(\omega) = \Phi_{yr}(\omega) \quad \text{w.p. 1} \quad (2.47a)$$

$$\lim_{N \rightarrow \infty} \hat{\Phi}_{ur,N}(\omega) = \Phi_{ur}(\omega) \quad \text{w.p. 1} \quad (2.47b)$$

and hence

$$\begin{aligned} \lim_{N \rightarrow \infty} \hat{G}_N(e^{i\omega}) &= \lim_{N \rightarrow \infty} \hat{\Phi}_{yr,N}(\omega)\hat{\Phi}_{ur,N}^{-1}(\omega) = \Phi_{yr}(\omega)\Phi_{ur}^{-1}(\omega) \\ &= G_0(e^{i\omega}) \quad \text{w.p. 1.} \end{aligned} \quad (2.48)$$

To summarize, the spectral estimate (2.46) is asymptotically unbiased, provided the spectra  $\Phi_{yr}(\omega)$  and  $\Phi_{ur}(\omega)$  can be estimated consistently. Again windowing techniques are applied to smooth the estimate, at the cost of introducing a (small) bias. Spectral analysis can be used both for model validation and for data inspection before the identification is done.

## 2.4 Parametric identification

Using a parametric identification method, a low order model can be obtained. It has been shown by, e.g., Gustavsson *et al.* (1977, 1981), that if the data is obtained in closed loop, it might occur that no unique parameter can be determined. This problem is solved, in general, by explicitly assuming the presence of a sufficiently exciting external input signal, as is stated in Assumption 2.3.

In this section, we discuss several closed-loop identification methods based on two parametric identification methods (PEM, IV). For each method asymptotic expressions are derived to evaluate the bias distribution. Conditions under which Requirement 2.2 is fulfilled are derived.



For a more extensive treatment of the different methods, we refer to the literature that is mentioned in each section. A general overview of closed-loop identification and its specific problems is provided by Gustavsson *et al.* (1977, 1981), although, of course, they describe the status of the research at that time. For example, the Two-Step method, discussed in Section 2.4.5, had not yet been developed.

### 2.4.1 Direct Identification method

The Direct Identification method (DI) consists of the straightforward application of a PEM to the data set  $\{y_t, u_t\}_N$ , neglecting the presence of feedback.

The model  $\hat{\theta}_N$  is obtained as

$$\hat{\theta}_N = \arg \min_{\theta \in \Theta} V_{\text{DI},N}(\theta) \quad (2.49a)$$

$$V_{\text{DI},N}(\theta) = \text{tr} \frac{1}{N} \sum_{t=1}^N [L(q)\varepsilon_{y,t}(\theta)][L(q)\varepsilon_{y,t}(\theta)]' \quad (2.49b)$$

$$\varepsilon_{y,t}(\theta) = H^{-1}(\theta)[y_t - G(\theta)u_t] \quad (2.49c)$$

with  $L \in \mathbb{R}^{p \times p}(z)$  a prediction error prefilter, just as in the open-loop case.

The difference between this and the open-loop situation is that  $u_t$  is now correlated with the noise. Filling in the loop dynamics (2.42), we obtain

$$\varepsilon_{y,t}(\theta) = H^{-1}(\theta)\{[G_0 - G(\theta)]S_0^{(i)}r_t + [I_p + G(\theta)C_b]S_0^{(o)}v_t\}. \quad (2.50)$$

Analogously to (2.38a), we define the model output sensitivity function  $S^{(o)}(\theta) \in \mathbb{R}^{p \times p}(z)$  as

$$S^{(o)}(\theta) = [I_p + G(\theta)C_b]^{-1} \quad (2.51)$$

and hence

$$\varepsilon_{y,t}(\theta) = H^{-1}(\theta)\{[G_0 - G(\theta)]S_0^{(i)}r_t + [S^{(o)}(\theta)]^{-1}S_0^{(o)}v_t\}. \quad (2.52)$$

Since  $r_t$  and  $v_t$  are independent, the asymptotic expression for  $V_{\text{DI},N}(\theta)$  becomes

$$V_{\text{DI},\infty}(\theta) = \left\| LH^{-1}(\theta)[G_0 - G(\theta)]S_0^{(i)}\Phi_r^{1/2} \quad LH^{-1}(\theta)[S^{(o)}(\theta)]^{-1}S_0^{(o)}\Phi_v^{1/2} \right\|_2^2. \quad (2.53)$$

It can be seen that (2.53) is minimal if the model  $(G(\theta_\infty), H(\theta_\infty))$  is equal to  $(G_0, H_0)$ , and hence  $\mathcal{S} \in \mathcal{M}$ .

However, if  $H(\theta_\infty) \neq H_0$ , the difference  $G_0 - G(\theta)$  is influenced by this discrepancy, and (2.53) is not necessarily minimal for  $G(\theta_\infty) = G_0$ . Hence, if  $G_0 \in \mathcal{G}$ , but  $\mathcal{S} \notin \mathcal{M}$ , DI will, in general, give a biased estimate.

Concerning the bias term, it is clear from (2.53) that the inclusion of a prediction error prefilter  $L$  does not give straightforward control over the bias distribution of the limit model  $\theta_\infty$ , since the bias distribution still depends on the noise model. Even if  $G$  and  $H$  are independently parametrized this holds true.

As a conclusion we state that DI does not fulfill Requirement 2.2. However, in spite of the disadvantages just mentioned, DI is still widely applied in practice, because of its simplicity.

An alternative parametrization can solve the consistency problem. If the transfer function between  $r$  and  $y$  is parametrized as

$$y_t = G(\theta)[I_m + C_b G(\theta)]^{-1} r_t + H(\theta) e_t \quad (2.54a)$$

$$= G(\theta) S^{(i)}(\theta) r_t + H(\theta) e_t \quad (2.54b)$$

with  $S^{(i)}(\theta)$  the model input sensitivity function, then the prediction error becomes

$$\varepsilon_{y,t} = H^{-1}(\theta) \{ [G_0 S_0^{(i)} - G(\theta) S^{(i)}(\theta)] r_t + S_0^{(o)} v_t \}. \quad (2.55)$$

The asymptotic expression for  $V_{DI,N}(\theta)$  then is

$$V_{DI,\infty}(\theta) = \left\| LH^{-1} [G_0 S_0^{(i)} - G(\theta) S^{(i)}(\theta)] \Phi_r^{1/2} \quad LH^{-1}(\theta) S_0^{(o)} \Phi_v^{1/2} \right\|_2^2. \quad (2.56)$$

If  $G_0 \in \mathcal{G}$  but  $\mathcal{S} \notin \mathcal{M}$ ,  $S_0^{(i)}$  can be estimated consistently, and hence  $G_0$  can be estimated consistently:  $G(\theta_\infty) = G_0$ .

Hence, by using a more complex parametrization the consistency problem is solved, at the cost of a computationally more involved optimization problem.

DI has been considered by many authors. Identifiability conditions have been derived by Ljung *et al.* (1974), Söderström *et al.* (1974, 1975), Wellstead (1978) and Anderson and Gevers (1982). Bias correction algorithms have been proposed by Aude and Sandoz (1986).

### 2.4.2 Indirect Identification method

The Indirect Identification method (II) consists of two sequential steps:

1. Identify the closed-loop transfer function between the external input  $r$  and the output  $y$ ,
2. Calculate  $\hat{G}$  from this estimate and the known feedback controller  $C_b$ .

#### Step 1

In the first step the closed-loop model  $(G_c(\hat{\theta}_N), H_c(\hat{\theta}_N))$  is estimated from  $\{y_t, r_t\}_N$ . The true closed-loop system  $(G_{c,0}, H_{c,0})$  is given by

$$G_{c,0}(z) = G_0(z)S_0^{(0)}(z) \quad (2.57a)$$

$$H_{c,0}(z) = S_0^{(0)}(z)H_0(z) \quad (2.57b)$$

which can be seen from (2.42).

The asymptotic expression for this first step is

$$V_{II,\infty}(\theta) = \left\| LH_c^{-1}(\theta)[G_0S_0^{(0)} - G_c(\theta)\Phi_r^{1/2} \quad LH_c^{-1}(\theta)S_0^{(0)}\Phi_v^{1/2} \right\|_2^2. \quad (2.58)$$

From this expression it follows that, if  $G_{c,0} \in \mathcal{G}_c$  (where  $\mathcal{G}_c$  is the set of closed-loop models) and  $G_c(\theta)$  and  $H_c(\theta)$  are independently parametrized,  $\hat{G}_c(z) = G_{c,0}(z)$  asymptotically, with probability one. The prefilter  $L$  serves to shape the bias distribution of  $\hat{G}_c$  if  $G_{c,0} \notin \mathcal{G}_c$ .

#### Step 2

We need a process model  $\hat{G}$ , which can be calculated from  $\hat{G}_c$  and  $\hat{H}_c$ . Analogously to (2.57), we define

$$G_c(\hat{\theta}_N) = G(\hat{\theta}_N)[I_m + C_bG(\hat{\theta}_N)]^{-1} \quad (2.59a)$$

$$H_c(\hat{\theta}_N) = [I_p + G(\hat{\theta}_N)C_b]^{-1}H(\hat{\theta}_N). \quad (2.59b)$$

A model  $(\hat{G}, \hat{H})$  is now obtained as

$$G(\hat{\theta}_N) = [I_p - G_c(\hat{\theta}_N)C_b]^{-1}G_c(\hat{\theta}_N) \quad (2.60a)$$

$$H(\hat{\theta}_N) = [I_p - G_c(\hat{\theta}_N)C_b]^{-1}H_c(\hat{\theta}_N). \quad (2.60b)$$

We see that if  $\hat{G}_c(z) = G_{c,0}(z)$ ,  $\hat{G}$  is calculated exactly. Consequently, II can give a consistent estimate  $\hat{G}$  if  $G_{c,0} \in \mathcal{G}_c$ .

The bias tuning of  $\hat{G}$ , however, if  $G_{c,0} \notin \mathcal{G}_c$ , is not straightforward: it is not clear how a prediction error prefilter in the first step influences the result of the second step.

Note that the difference between DI with the complex parametrization (2.56) and II (2.58) is that in DI the parametrization is induced beforehand, resulting in a complex optimization problem, whereas in II there is no *a priori* closed-loop parametrization. Therefore the problems in II will occur in the second step, where the model is calculated from the estimated closed-loop model.

In the second step the dynamics of the model sensitivity function should be canceled by the closed-loop model. In general this cancellation is not exact, due to the numerical accuracy and the finiteness of the data set. Therefore, usually a model reduction step is necessary to smooth the solution.

Properties of II have been considered by Ljung *et al.* (1974), Söderström *et al.* (1974, 1975), Graupe (1975), Gevers (1978), and by Zheng and Feng (1991).

### 2.4.3 Joint Input-Output method

The basic idea behind the Joint Input-Output method (JIO) is that the closed-loop system is viewed as a black box, with white-noise sources as input, and the process inputs and outputs as the output. Denoting this joint signal by  $z_t$ , we have

$$z_t = \begin{pmatrix} y_t \\ u_t \end{pmatrix}. \quad (2.61)$$

The inputs of the closed-loop system are, possibly fictitious, white-noise sources. Hence it is assumed that there are monic, stable and inversely stable transfer functions  $H_0 \in \mathbb{R}^{p \times p}(z)$  and  $K_0 \in \mathbb{R}^{m \times m}(z)$ , such that

$$v_t = H_0(q)\chi_{y,t} \quad , \quad r_t = K_0(q)\chi_{u,t} \quad (2.62)$$

with  $\chi_{y,t}$  and  $\chi_{u,t}$  white noise, with

$$\mathbb{E} \left\{ \begin{pmatrix} \chi_{y,i} \\ \chi_{u,i} \end{pmatrix} \begin{pmatrix} \chi'_{y,j} & \chi'_{u,j} \end{pmatrix} \right\} = Q\Delta_{ij} \quad (2.63)$$

with  $Q > 0$ , and  $\Delta_{ij}$  the unit pulse:

$$\Delta_{ij} = \begin{cases} 1 & \text{if } i = j \quad i, j \in \mathbb{Z} \\ 0 & \text{if } i \neq j \quad i, j \in \mathbb{Z} \end{cases} \quad (2.64)$$

For  $z_t$  the following holds.

$$z_t = W_0(q) \begin{pmatrix} \chi_{y,t} \\ \chi_{u,t} \end{pmatrix} \quad (2.65)$$

with

$$W_0 = \begin{bmatrix} W_{11} & W_{12} \\ W_{21} & W_{22} \end{bmatrix} = \begin{bmatrix} S_0^{(o)} H_0 & G_0 S_0^{(o)} K_0 \\ -C_b S_0^{(o)} H_0 & S_0^{(o)} K_0 \end{bmatrix}. \quad (2.66)$$

The filter  $W_0(z)$  is stable and inversely stable, since the closed loop is assumed to be stable (Assumption 2.3).

Manipulating the above equations, it can be shown that

$$G_0(z) = W_{12}(z)W_{22}^{-1}(z) \quad (2.67)$$

$$C_b(z) = -W_{21}(z)W_{11}^{-1}(z) \quad (2.68)$$

$$H_0(z) = W_{11}(z) - W_{12}(z)W_{22}^{-1}(z)W_{21}(z) \quad (2.69)$$

$$K_0(z) = W_{22}(z) - W_{21}(z)W_{11}^{-1}(z)W_{12}(z). \quad (2.70)$$

The JIO approach to closed-loop identification is to estimate the filter  $W_0(z)$ , and then calculate  $\hat{G}$  as

$$\hat{G}(z) = \hat{W}_{12}(z)\hat{W}_{22}^{-1}(z). \quad (2.71)$$

Note that not only  $\hat{G}$  can be calculated, but so can  $\hat{C}_b$ ,  $\hat{H}$  and  $\hat{K}$ , as estimates of  $C_b$ ,  $H_0$  and  $K_0$ , respectively.

There are three possible ways of obtaining an estimate  $\hat{W}$  of  $W_0$ :

1. Prediction Error Method, using the time series  $\{z_t\}_N$  to estimate  $\hat{W}$  as a "noise" model (Söderström and Stoica, 1989);

2. Spectral factorization, using the spectrum  $\Phi_z(\omega)$  to obtain  $\hat{W}$  (Anderson and Gevers, 1979);
3. Stochastic realization, using the autocovariance of  $z_t$  to obtain  $\hat{W}$  (Van der Klauw *et al.*, 1991).

In all cases, the estimate  $\hat{W}(z)$  will be monic:  $\hat{W}(\infty) = I_{p+m}$ . However,  $W_0(z)$  in (2.66) is not monic, since

$$W_0(\infty) = \begin{bmatrix} I_p & G_0(\infty) \\ -C_b(\infty) & I_m \end{bmatrix} \quad (2.72)$$

which is not equal to the identity matrix in general.

To make  $W_0$  monic, it is postmultiplied by  $W_0^{-1}(\infty)$ , resulting in  $\tilde{W}_0(z)$ :

$$\tilde{W}_0(z) = W_0(z)W_0^{-1}(\infty) = W_0(z) \begin{bmatrix} I_p & -G_0(\infty) \\ C_b(\infty) & I_m \end{bmatrix} \quad (2.73)$$

We then have

$$z_t = \tilde{W}_0(q)\tilde{\chi}_t \quad (2.74a)$$

$$\tilde{\chi}_t = W(\infty)\chi_t \quad (2.74b)$$

$$\tilde{Q} = W(\infty)QW'(\infty). \quad (2.74c)$$

The estimate  $\hat{W}$  is consistent if  $\hat{W} = \tilde{W}_0$ .

If we assume that the process  $G_0$  contains a delay, then

$$G_0(\infty) = \mathbf{0}_{p \times m} \quad (2.75)$$

In this case the estimate  $\hat{G}$  can be obtained as

$$\hat{G}(z) = \tilde{W}_{12}(z)\tilde{W}_{22}^{-1}(z). \quad (2.76)$$

When using stochastic realization, (2.76) is the controllable and observable part of  $\tilde{W}_{12}\tilde{W}_{22}^{-1}$  in state space notation (Van der Klauw *et al.*, 1991).

For the more general assumption (2.36) the calculation of  $\hat{G}$  is more difficult.

In the same way as for the II method, it can be shown that if the first step, the estimation of  $W_0$  or  $\tilde{W}_0$ , is consistent, then so will  $\hat{G}$  be. However, the final result  $\hat{G}$  appears to be very sensitive to errors made in  $\hat{W}$  (Van der Klauw *et al.*, 1991), and it is not clear in what way the resulting model could be influenced.

Summarizing the properties of JIO, we see that

- all input signals must be equivalent to a filtered white-noise signal;
- if there is no input noise, and no external input signal, JIO cannot be applied, since  $Q$  is then no longer positive definite;
- in the first step, a much larger model is identified than is strictly necessary, since we only want to find  $\hat{G}$ ;
- the model  $\hat{G}$  (2.76) is nothing but the filter between  $\chi_{u,t}$  and  $y_t$ , multiplied by the inverse filter between  $\chi_{u,t}$  and  $u_t$ . If there is a measurable external input signal  $r_t$ , as is assumed, it is equivalent to the filter between  $r_t$  and  $y_t$ , multiplied by the inverse filter between  $r_t$  and  $y_t$ , without the restriction that  $r_t$  is filtered white noise.

Because of the last item, and because of the sensitivity of  $\hat{G}$  with respect to the errors made in the first step, it is preferable to use a method that explicitly uses the measured signal  $r_t$ .

The JIO method has been treated by several authors. A general setting on feedback systems is provided by Caines and Chan (1975, 1976), Gevers and Anderson (1981), and by Anderson and Gevers (1983). Identifiability with JIO has been considered by Ng *et al.* (1977), Anderson and Gevers (1979, 1982), Sin and Goodwin (1980), and by Aling and Bosgra (1990).

Most of the literature considers the JIO method with spectral factorization. The stochastic realization approach has been discussed by Aling (1990) and by Van der Klauw *et al.* (1991). Techniques for solving the stochastic realization problem and the associated matrix Riccati equation are given by, e.g., Faurre (1976), Faurre *et al.* (1979), Lindquist and Picci (1979, 1985), Pappas *et al.* (1980), Pavon (1980), Van Dooren (1981), Lindquist and Pavon (1984), Van der Schaft and Willems (1984), and Aoki (1987).

#### 2.4.4 Instrumental Variable method

The Instrumental Variable method (IV) can be used for closed-loop identification as well (Söderström *et al.*, 1987; Van Osch, 1992). The problem is, as in the open-loop case, the choice of suitable instruments  $\zeta_t$ . Again a suitable instrumental variable is a signal (matrix)  $\zeta_t$ , such that (2.28) holds.

##### *Basic instruments*

Two different ways of generating basic instruments have been proposed:

1. past external inputs
2. delayed process inputs and process outputs.

In the first case, the tensor of instrumental variables consists of  $d$  past values of  $r_t$  only. The success of this variant is dependent on the signal-to-noise ratio of  $u_t$ .

In the second case, the tensor of instruments consists of values of  $y_t$  and  $u_t$ , delayed by  $n$  samples and more, where it is assumed that the noise  $v_t$  is the realization of white noise, filtered through a moving average filter of an order not exceeding  $n$ .

The asymptotic expressions  $f_{I,\infty}(\theta)$  are, in both cases, the  $d$ -vector

$$f_{I,\infty}(\theta) = \frac{1}{2\pi} \int_{-\pi}^{\pi} K_r(e^{i\omega}) \Phi_r(\omega) \cdot \left[ A(e^{i\omega}, \theta) \{ G_0(e^{i\omega}) - G(e^{i\omega}, \theta) \} S_0^{(0)}(e^{i\omega}) \right]^* d\omega. \quad (2.77)$$

In the first case,  $K_r$  consists of delay operators only. In the second case,  $K_r$  is an unknown tensor, dependent on  $G_0$ ,  $H_0$ ,  $C_b$  and  $C_f$ .

The calculation of basic instruments is very simple. However, in general, large data sets are necessary to obtain an unbiased model, since IV is based on stochastic, and therefore asymptotic, properties. The success of these IV methods depends on the degree of truth of the afore-mentioned assumptions.

### Noise-free instruments

To satisfy (2.28), the instruments should be highly correlated with the noise-free part of the data, and independent of the noisy part. Hence it makes sense to reconstruct the noise-free part of the data.

We mention two different ways of using reconstructed noise-free signals in closed-loop identification:

1. as instrumental variables
2. as substitution of the data, in a PEM.

In the first case, the instruments are calculated by identifying the transfer function matrices  $H_{yr}(z)$  between  $r_t$  and  $y_t$ , and  $H_{ur}(z)$  between  $r_t$  and  $u_t$ , since

$$y_t = G_0 S_0^{(i)} r_t + S_0^{(o)} v_t = H_{yr}(q) r_t + v_{y,t} \quad (2.78a)$$

$$u_t = S_0^{(i)} r_t - C_b S_0^{(o)} v_t = H_{ur}(q) r_t + v_{u,t}. \quad (2.78b)$$



Estimating the transfer function matrices, and denoting them by  $\hat{H}_{yr}$  and  $\hat{H}_{ur}$ , respectively, we obtain the noise-free estimates as

$$\hat{y}_t^r = \hat{H}_{yr} r_t \quad (2.79a)$$

$$\hat{u}_t^r = \hat{H}_{ur} r_t. \quad (2.79b)$$

These can be used as instrumental variables. The corresponding asymptotic expression for  $f_I(\theta)$  then becomes

$$f_{I,\infty}(\theta) = \frac{1}{2\pi} \int_{-\pi}^{\pi} K_r(e^{i\omega}, \hat{H}_{yr}, \hat{H}_{ur}) \Phi_r(\omega) \cdot [A(e^{i\omega}, \theta) \{G_0(e^{i\omega}) - G(e^{i\omega}, \theta)\} S_0^{(0)}(e^{i\omega})]^* d\omega. \quad (2.80)$$

Clearly,  $G_0$  can be estimated consistently if  $G_0 \in \mathcal{G}$ . However, again a large data set is needed.

In the second case, the noise-free signals  $\hat{y}_t$  and  $\hat{u}_t$  are used to replace the data  $\{y_t, u_t\}_N$ . Applying a PEM to the new data set  $\{\hat{y}_t^r, \hat{u}_t^r\}_N$ , a model  $\hat{G}$  can be calculated. The corresponding asymptotic expression for  $V_N(\theta)$  is

$$V_\infty(\theta) = \left\| \left[ \hat{H}_{yr} - G(\theta) S^{(0)} \right] \Phi_r^{1/2} \right\|_2^2. \quad (2.81)$$

If  $\hat{H}_{yr}$  is a consistent estimate, so can  $\hat{G}$  be. However, since the effects of modeling errors in the first step cannot be made explicit, this method is not preferred.

Instrumental Variable methods were originally designed for open-loop identification. Their use for closed-loop systems has been addressed by few authors. They all assume that there is an external excitation signal, from which the instruments can be calculated. Bauer and Unbehauen (1978) describe such an approach, and it is proved by Söderström and Stoica (1981) that the method gives consistent estimates under weak conditions. Söderström *et al.* (1987) analyze the distribution of IV estimates, and propose an optimal IV estimator (optimal in the sense that the parameter variance is minimized). Van Osch (1992) has developed several closed-loop IV variants for multivariable systems, and compares them to PEM-based methods by applying them to laboratory data.

### 2.4.5 Two-Step method

A recently developed closed-loop identification method, introduced by Van den Hof and Schrama (1992, 1993), is the Two-Step method (TS). It is based on the observation that,

from (2.42), we have

$$\begin{cases} u_t = S_0^{(i)} r_t - C_b S_0^{(o)} v_t = u_t^r - C_b S_0^{(o)} v_t \\ y_t = G_0 S_0^{(i)} r_t + S_0^{(o)} v_t = G_0 u_t^r + S_0^{(o)} v_t. \end{cases} \quad (2.82)$$

The nonmeasurable or *auxiliary* signal  $u^r$  can be reconstructed and subsequently be used for identification of  $G_0$ .

As the name suggests, the Two-Step method consists of two steps:

1. Identify  $S_0^{(i)}$  from  $\{u_t, r_t\}_N$ , and calculate the noise-free input signal  $\hat{u}_t^r = \hat{S}^{(i)} r_t$ ;
2. Identify  $\hat{G}$  as the transfer function matrix between  $\hat{u}_t^r$  and  $y_t$ .

In the first step  $S^{(i)}$  is parametrized with parameter vector  $\beta$ . Since no noise model is needed, and since process and noise model should be independently parametrized for  $\hat{S}^{(i)}$  to be consistent,  $S^{(i)}$  can have, for example, an FIR, OE or ORTFIR (ORTHOgonal FIR, Heuberger (1991) and Section 3.3) parametrization, possibly extended with a fixed noise model.

Since, in general, control design does not require a noise model,  $\hat{G}$  can be parametrized as an OE model.

Suppose that a fixed noise model  $H_u(z)$  is used in the first step. This is equivalent to filtering the prediction error with a prefilter  $H_u^{-1}(z)$ . Then the asymptotic expression for  $V_N(\beta)$  is (Van den Hof and Schrama, 1993)

$$V_\infty(\beta) = \left\| H_u^{-1} \left[ S_0^{(i)} - S^{(i)}(\beta) \right] \Phi_r^{1/2} \quad H_u^{-1} C_b S_0^{(o)} \Phi_v^{1/2} \right\|_2^2. \quad (2.83)$$

If the second step is parametrized with parameter vector  $\theta$ , and if a fixed noise model  $H_y(z)$  is used, the asymptotic expression for  $V_N(\theta)$  in the second step becomes

$$V_\infty(\theta) = \left\| H_y^{-1} \left[ G_0 S_0^{(i)} - G(\theta) S^{(i)}(\hat{\beta}) \right] \Phi_r^{1/2} \quad H_y^{-1} S_0^{(o)} \Phi_v^{1/2} \right\|_2^2. \quad (2.84)$$

Noting that the first part of (2.84) can be rewritten as (Van den Hof and Schrama, 1993)

$$\left[ G_0 S_0^{(i)} - G(\theta) S^{(i)}(\hat{\beta}) \right] = \underbrace{[G_0 - G(\theta)] S_0^{(i)}}_{\text{second step}} + \underbrace{G(\theta) [S_0^{(i)} - S^{(i)}(\hat{\beta})]}_{\text{first step}} \quad (2.85)$$

we see that the final error consists of a part that stems from the first step, and a part that stems from the second step. Consequently, if the first step is executed very accurately, the error in the second step, the actual identification of  $\hat{G}$ , gives the largest contribution to the final total error.

The TS method is schematically shown in Figure 2.3, where the upper part denotes the real process, and the lower part denotes the model.

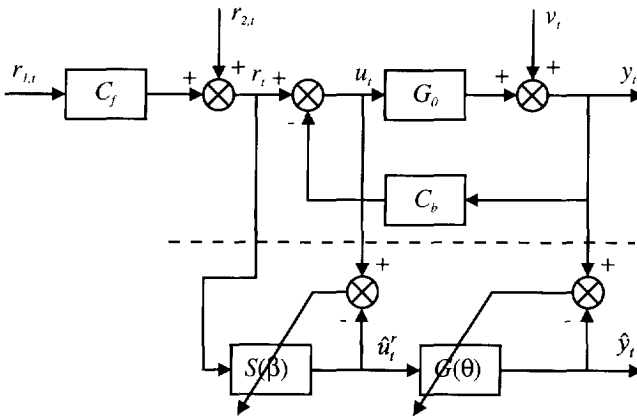

Figure 2.3. Schematic drawing of the Two-Step method (TS), with the upper part denoting the real system, and the lower part denoting the models involved

We see from (2.84) that, if the first step is consistent, then, if  $G_0 \in \mathcal{G}$ , but  $\mathcal{S} \notin \mathcal{M}$ ,  $\hat{G}$  can be estimated consistently as well, irrespective of the noise models  $H_y$  and  $H_u$ .

If  $G_0 \notin \mathcal{G}$ , we have a tunable bias expression (2.84), where  $H_y$  can be used to shape the bias distribution. However, the influence of the first step on the second step is not explicit.

## 2.5 Generalized closed-loop identification method

Doing both steps of the Two-Step method simultaneously results in a more complex optimization problem, but it also makes the mutual influence of both steps explicit. The resulting closed-loop identification method is a generalization of the Two-Step method, and it appears to unify the other PEM-based closed-loop identification methods, described in the previous sections, as well. These methods appear as special cases by making specific choices for the design variables in the identification algorithm. Therefore the

generalization enables a good comparison between the different closed-loop identification methods.

In this section, we propose this *Generalized Identification* method, and analyze its properties.

The loss function of the Generalized Identification method (GI) is  $V_{\text{GI},N}(\theta)$ , defined as

$$V_{\text{GI},N}(\theta) = \frac{1}{N} \sum_{t=1}^N \left\{ \{L_y[y_t - \hat{y}_t(\theta)]\}' \{L_y[y_t - \hat{y}_t(\theta)]\} + \lambda^2 \{L_u[u_t - \hat{u}_t(\theta)]\}' \{L_u[u_t - \hat{u}_t(\theta)]\} \right\} \quad (2.86)$$

with  $L_y \in \mathbb{R}^{p \times p}(z)$  and  $L_u \in \mathbb{R}^{m \times m}(z)$  monic stable matrix filters.

By defining  $z_t = (y_t' \ u_t')'$  as in (2.61),  $V_{\text{GI},N}(\theta)$  can be rewritten as

$$V_{\text{GI},N}(\theta) = \frac{1}{N} \sum_{t=1}^N \left\{ \{L[z_t - \hat{z}_t(\theta)]\}' \{L[z_t - \hat{z}_t(\theta)]\} \right\} \quad (2.87)$$

with

$$L = \begin{bmatrix} L_y & \mathbf{0}_{p \times m} \\ \mathbf{0}_{m \times p} & \lambda L_u \end{bmatrix} \quad (2.88)$$

It can be seen that GI generalizes several of the discussed closed-loop identification methods by choosing specific parametrizations of  $\hat{y}$  and  $\hat{u}$  and filters  $L_y$  and  $L_u$ . This is illustrated here.

**DI 1:** Consider the choice

$$\hat{u}_t(\theta) = u_t \quad (2.89a)$$

$$\hat{y}_t(\theta) = G(\theta)u_t. \quad (2.89b)$$

The term  $u - \hat{u}$  in (2.86) is zero, so this choice results in DI.

**DI 2:** If we choose

$$\hat{u}_t(\theta) = [I_m + C_b G(\theta)]^{-1} r_t \quad (2.90a)$$

$$\hat{y}_t(\theta) = G(\theta)\hat{u}_t(\theta) \quad (2.90b)$$

and  $\lambda = 0$ , we obtain DI with the alternative parametrization of Section 2.4.1.

**II:** By choosing

$$\hat{u}_t(\theta) = u_t \quad (2.91a)$$

$$\hat{y}_t(\theta) = G_c(\theta)r_t \quad (2.91b)$$

the term  $u - \hat{u}$  in (2.86) is zero, and  $\hat{G}_c$  is a model of the closed-loop system. Then  $\hat{G}$  can be calculated from  $\hat{G}_c$  and knowledge of  $C_b$ , which is equivalent to II.

**JIO:** Choosing  $L_y(z) = L_u(z) = 1$ , and

$$\hat{z}_t(\theta) = \begin{pmatrix} \hat{y}_t(\theta) \\ \hat{u}_t(\theta) \end{pmatrix} = W(\theta)\chi_t \quad (2.92a)$$

$$G(\hat{\theta}) = W_{12}(\hat{\theta})[W_{22}(\hat{\theta})]^{-1} \quad (2.92b)$$

with  $\chi_t$  white noise, GI is equivalent to JIO. This requires  $r_t$  to be a realization of filtered white noise.

**TS:** If we choose

$$\hat{u}_t(\beta) = S^{(i)}(\beta)r_t \quad (2.93a)$$

$$\hat{y}_t(\theta) = G(\theta)S^{(i)}(\hat{\beta})r_t \quad (2.93b)$$

we clearly obtain the TS method.

Hence, GI unifies DI, II, JIO and TS. However, GI does more: it enables the user to specify identification filters, and hence to tune the bias distribution according to specific needs, for example, induced by the control design procedure. Moreover, the influence of the estimation of  $\hat{S}^{(i)}$  on  $\hat{G}$  can be studied.

The general choice

$$\hat{u}_t(\beta) = S^{(i)}(\beta)r_t \quad (2.94a)$$

$$\hat{y}_t(\theta) = G(\theta)S^{(i)}(\beta)r_t \quad (2.94b)$$

results in a complex optimization problem, with

$$(\theta_\infty, \beta_\infty) = \arg \min_{\theta, \beta \in \Theta} V_{\text{GI}, \infty}(\theta, \beta) \quad (2.95)$$

and

$$\begin{aligned}
 V_{\text{GI},\infty}(\theta, \beta) &= \left\| \begin{bmatrix} L_y[G_0 S_0^{(i)} - G(\theta)S^{(i)}(\beta)]\Phi_r^{1/2} & L_y S_0^{(o)}\Phi_v^{1/2} \\ \lambda L_u[S_0^{(i)} - S^{(i)}(\beta)]\Phi_r^{1/2} & \lambda L_u C_b S_0^{(o)}\Phi_v^{1/2} \end{bmatrix} \right\|_2^2 \\
 &= \left\| \begin{bmatrix} L_y & 0 \\ 0 & \lambda L_u \end{bmatrix} \begin{bmatrix} G_0 S_0^{(i)} - G(\theta)S^{(i)}(\beta) & S_0^{(o)} \\ S_0^{(i)} - S^{(i)}(\beta) & C_b S_0^{(o)} \end{bmatrix} \begin{bmatrix} \Phi_r^{1/2} & 0 \\ 0 & \Phi_v^{1/2} \end{bmatrix} \right\|_2^2 \quad (2.96)
 \end{aligned}$$

Analyzing (2.96), we see that the minimizing argument of  $V_{\text{GI},\infty}$  is independent of the noise, since

$$\arg \min_{\theta, \beta \in \Theta} V_{\text{GI},\infty}(\theta, \beta) = \arg \min_{\theta, \beta \in \Theta} \left\| \begin{bmatrix} L_y[G_0 S_0^{(i)} - G(\theta)S^{(i)}(\beta)]\Phi_r^{1/2} \\ \lambda L_u[S_0^{(i)} - S^{(i)}(\beta)]\Phi_r^{1/2} \end{bmatrix} \right\|_2. \quad (2.97)$$

Hence there is no noise term involved in the determination of  $\theta_\infty$  and  $\beta_\infty$ .

From (2.97) we can conclude that the models  $\hat{G}$  and  $\hat{S}^{(i)}$  are consistent estimates, if  $G_0 \in \mathcal{G}$  and  $S_0^{(i)} \in \mathcal{G}_S$ , where  $\mathcal{G}_S$  is the set of sensitivity models. Otherwise the parameters will be a compromise between fitting  $S_0^{(i)}$  and fitting  $G_0 S_0^{(o)}$ .

The bias in the models is directly tunable through the filters  $L_y$  and  $L_u$ . The use of these filters to incorporate control design specifications is reported in Chapter 4.

The spectrum,  $\Phi_r$ , of the input signal has a direct influence on both the bias and the variance. This fact is used for input design in Chapter 5.

The use of the Generalized Identification method results in a nonlinear optimization problem. The parametrization of  $G$  is usually chosen as an OE, as in TS. The sensitivity function  $S$  is usually parametrized as an FIR or an ORTFIR model, the latter possessing the advantage of having fewer parameters, resulting in both a smaller bias and a smaller variance of the estimates (Van den Hof *et al.*, 1994). The ORTFIR parametrization is briefly discussed in the next chapter.

## 2.6 Conclusions

The closed-loop identification problem is concerned with determining a model from closed-loop data. All methods described in this chapter, spectral analysis, DI, II, JIO, IV, TS and GI, are capable of obtaining a model from closed-loop data. But not all methods fulfill Requirement 2.2.

Spectral analysis gives a rough estimate of  $G_0$ , and is therefore suitable for model validation and data inspection, but not for control design.

The requirement of consistent estimation in the case where  $G_0 \in \mathcal{G}$  but  $\mathcal{S} \notin \mathcal{M}$  implies that DI is no longer a candidate procedure. This stems from the fact that DI can estimate consistently only if the noise model is estimated correctly. Even if a BJ parametrization is used, this requires a noise model of too high an order.

Another requirement is that a tunable bias expression should result, such that possible information on the control design procedure can be incorporated. This is not possible with II and JIO.

IV and TS provide parametric models, and result in a tunable asymptotic bias expression. However, the exact way in which the first step of TS influences the second step is not explicit. Therefore we have proposed a generalized closed-loop identification method (GI) that performs both steps in one step. This results in a computationally more involved procedure, but the different choices to be made have a clearer effect on the final model.

It has been shown that the PEM-based methods appear as special cases of GI, by making specific choices for the design variables  $\lambda$ , the identification filters and the parametrization. This enables a comparison between the different methods.

Identification filters  $L_y$  and  $L_u$  make it possible to incorporate control design specifications in the identification procedure, in order to obtain a desired bias distribution. Hence, with GI it is possible to fulfill Requirement 2.2.





## Chapter 3

---

# Parametrization aspects

### 3.1 Introduction

The previous chapter was mainly on the estimation of parameters within a given model structure or *parametrization*. A parametrization  $\Pi$  was defined by (2.5)–(2.7) as a mapping from the parameter vector  $\theta$  to a model  $(G(z, \theta), H(z, \theta))$ .

For black-box identification, a parametrization is selected by the user. Since this choice influences the numerical conditioning of the associated parameter estimation problem, it is important that a suitable parametrization is selected.

For SISO systems, model structure selection involves the choice of the dead time, and the degree of all polynomials in the model.

For MIMO systems, model structure selection involves the choice of the dead times from all inputs to all outputs (*pm* dead times), and the degree of all polynomials in the matrices, if a Matrix Fraction Description (MFD) is used, or the nonzero entries in the state space matrices, if a state space representation is used.

In all cases, the structure of the model is uniquely specified by a set of integers, usually referred to as the *structure indices*.

The choice of a parametrization is the subject of this chapter. Estimation of dead time is discussed in Section 3.2. In Section 3.3 the Orthogonal FIR (ORTFIR) parametrization (Heuberger, 1991) is described, which was suggested in the previous chapter as a suitable parametrization for the sensitivity function in TS and GI.

In Section 3.4, a method is proposed which enables an easy determination of a suitable set of structure indices for multivariable systems. The discussion is restricted to the input-output model only, so the parametrization is seen as a mapping from  $\theta$  to  $G(z, \theta)$  only, as in (2.7).

In Section 3.5 a transformation of parametrization is proposed that results in *lattice algorithms*. These algorithms are derived for on-line identification. They already exist for AR and ARX model structures (Makhoul, 1977; Morf *et al.*, 1977, 1978, 1979; Lee *et al.*,

1981, 1982; Friedlander, 1983; Gevers and Wertz, 1983), but we extend them toward more general model structures for SISO systems. The change of parametrization appears to improve the conditioning of the parameter estimation problem. The resulting algorithms are illustrated with simulation examples.

Some conclusions are drawn in Section 3.6.

## 3.2 Dead-time estimation

Many industrial processes exhibit dead time. Possible causes of dead time, or *time delay*, are the physical dimensions of the process, which are such that, for example, it takes a while before a change in an input flow is noted at the output of a pipe; or the time it takes to evaluate a measurement, such that information is not available instantaneously.

If a system has a time delay of  $T_d$ , there is no correlation between the input at time  $t$  and the output at time  $t + \tau$ ,  $\tau < T_d$ . This indicates a zero value for the cross-covariance function of input and output, which can be used to estimate dead time (Ljung, 1987; Söderström and Stoica, 1989; Falkus, 1994). The *normalized* cross-covariance function  $r_{yu}(\tau)$  of input and output is defined as

$$r_{yu}(\tau) = \frac{R_{yu}(\tau)}{\sqrt{R_y(0)R_u(0)}} \quad (3.1)$$

where  $R_y(\tau)$  and  $R_u(\tau)$  are the covariance functions of  $y_t$  and  $u_t$ , respectively, and  $R_{yu}(\tau)$  is their cross-covariance matrix, estimated from  $N$  data points:

$$R_y(\tau) = \frac{1}{N} \sum_{t=1}^N y_t y_{t-\tau} \quad (3.2a)$$

$$R_u(\tau) = \frac{1}{N} \sum_{t=1}^N u_t u_{t-\tau} \quad (3.2b)$$

$$R_{yu}(\tau) = \frac{1}{N} \sum_{t=1}^N y_t u_{t-\tau}. \quad (3.2c)$$

If there is no correlation between  $y$  and  $u$ , it can be proven (Ljung, 1987) that

$$\sqrt{N}r_{yu}(\tau) \in \text{AsN}(0, P) \quad (3.3)$$

which means that the distribution of  $\sqrt{N}r_{yu}(\tau)$  tends asymptotically to a normal distribution with zero mean and variance  $P$ , which is given by

$$P = \frac{\sum_{k=-\infty}^{\infty} R_y(k)R_u(k)}{R_y(0)R_u(0)}. \quad (3.4)$$

The absence of correlation between  $y$  and  $u$ , or, in fact, the validity of (3.3), can be tested by a hypothesis test on  $r_{yu}(\tau)$ . Let  $N_\alpha$  be the  $\alpha$ -level of the  $\mathcal{N}(0, 1)$  distribution. Then the null hypothesis that there is no correlation between  $y$  and  $u$  for a given  $\tau$  is, with confidence  $1 - \alpha$ ,

$$H_0 : \quad |r_{yu}(\tau)| \leq \frac{\sqrt{P}}{\sqrt{N}} N_\alpha. \quad (3.5)$$

Frequently used values of  $\alpha$  are 0.05 and 0.01, with corresponding  $\alpha$ -levels  $N_{0.05} = 1.96$  and  $N_{0.01} = 2.58$ , resulting in confidence intervals of 95% and 99%, respectively.

The dead time can be determined by counting the number of lags, for which the null hypothesis (3.5) is accepted.

For multivariable systems, typically  $pm$  time delays have to be estimated. The hypothesis test should then be applied to each individual input-output pair. This results in a  $p \times m$  matrix of delays. For an example of the use of the hypothesis test, we refer the reader to Section 6.4, where the time delays of a distillation column are determined from measured data.

Dead time can be incorporated in a model structure by setting specific elements of the parameter vector to zero or one. However, for large time delays, it is better to compensate for dead time by shifting inputs and outputs, thus reducing the size of the parameter estimation problem.

Shifting of inputs and outputs can be done systematically by some algorithm (e.g., Falkus, 1994). For multivariable systems, in general, not more than  $m + p - 1$  time delays can be compensated, depending on their magnitudes, since this is the number of signals that can be shifted. The remaining delays must be incorporated in the model structure.

### 3.3 Orthogonal FIR parametrization

In system identification, the use of orthonormal basis functions as a basis to represent a system has received much attention of late (Heuberger, 1991; Wahlberg, 1991, 1994;

Heuberger *et al.*, 1993; Van den Hof *et al.*, 1994), because of the advantages they offer for system identification.

A classical FIR parametrization of a strictly proper scalar transfer function  $G(z)$  is a series expansion with (orthonormal) basis functions  $z^{-k}$ :

$$G(z) = \sum_{k=1}^{\infty} g_k z^{-k}. \quad (3.6)$$

This series expansion converges slowly in general. Hence, to accurately model  $G(z)$  with an FIR parametrization, a large number of parameters  $g_k$  must be determined, which results in a large variance of the estimates.

A series expansion of  $G(z)$  with generalized orthonormal basis functions  $V_k(z)$ ,  $k = 0, \dots, \infty$ , is written as

$$G(z) = \sum_{k=1}^{\infty} L_k V_k(z). \quad (3.7)$$

Heuberger *et al.* (1993) propose to use a scalar basis generating system  $G_b(z)$  with McMillan degree  $n_b$  which is inner ( $G_b(z)$  stable and  $G_b'(z^{-1})G_b(z) = 1$ ). They prove that if  $G_b(z)$  has a minimal balanced realization  $(A_b, B_b, C_b, D_b)$  and if the basis functions  $V_k(z)$  are generated as

$$V_k(z) = (zI - A_b)^{-1} B_b G_b^k(z), \quad (3.8)$$

the elements of  $V_k(z)$  form an orthonormal basis. Then the series expansion (3.7) is unique, with  $L_k \in \mathbb{R}^{1 \times n_b}$  and  $V_k \in \mathbb{R}^{n_b}(z)$ .

The basis (3.8) generalizes the classical basis functions, such as the pulse functions  $V_k(z) = z^{-k}$ , and the Laguerre and Kautz functions.

Using basis functions that contain dynamics can offer important advantages in identification and approximation problems. Heuberger *et al.* (1993) show that if the dynamics of the basis generating system  $G_b(z)$  approach the dynamics of the system to be modeled, the convergence rate of the series expansion (3.7) becomes very high. Then the number of coefficients to be determined to accurately model the system becomes smaller. Consequently, the variance of the parameter estimates is reduced.

The expressions in (3.7) and (3.8) are easily extended toward multivariable systems. We call (3.7) the *Orthogonal FIR* (ORTFIR) parametrization. It is a possible parametrization for the estimation of  $S$  in TS and GI.

## 3.4 MIMO model structure selection

In this section, a procedure is proposed to select a suitable model structure for the input-output model of multivariable systems. It is assumed that a model is identified by a PEM in a state space representation, since the identification in an MFD representation can give rise to nonproperness of input-output relations (Guidorzi, 1975; Gevers and Wertz, 1984). First we discuss the need for a *uniquely identifiable* parametrization, then the procedure is presented, and finally it is illustrated by a simulation example.

**Remark 3.1** If a Subspace Model Identification (SMI) algorithm is used to identify a multivariable system, a model is obtained by algebraic manipulations of the input-output data. A sequence of state vectors is calculated as the intersection of the space of past and future measurements. By manipulation of the input space, the output space, and the state space, the matrices of a state space representation are calculated. The model structure selection problem is then reduced to the choice of the model order, and the determination of dead time. There are no structure indices to be determined, since a structure is inferred from the data.

However, for the reasons mentioned in Chapter 2, we will not discuss the SMI algorithms, and we concentrate on the use of Prediction Error Methods.

### 3.4.1 Uniquely identifiable parametrizations

Consider the minimal state space representation

$$x_{t+1} = A_0 x_t + B_0 u_t \quad (3.9a)$$

$$w_t = C_0 x_t \quad (3.9b)$$

$$y_t = w_t + v_t \quad (3.9c)$$

with the input  $u_t \in \mathbb{R}^m$ , the output  $y_t \in \mathbb{R}^p$ , and the state vector  $x_t \in \mathbb{R}^n$ , where  $n$  is the McMillan degree of (3.9). The vector  $w_t \in \mathbb{R}^p$  represents a (nonmeasurable) noise-free output, and  $A_0 \in \mathbb{R}^{n \times n}$ ,  $B_0 \in \mathbb{R}^{n \times m}$ ,  $C_0 \in \mathbb{R}^{p \times n}$  are the state, input, and output matrix, respectively. It is assumed that the system is BIBO stable, and hence the eigenvalues of  $A_0$  are inside the unit circle.

Identification is concerned with determining a model  $(\hat{A}, \hat{B}, \hat{C})$  of the system  $(A_0, B_0, C_0)$ . To this end, the matrices  $A$ ,  $B$  and  $C$  are parametrized by a parameter vector  $\theta$ . The PEM identification criterion  $V_N(\theta)$  depends on  $(A(\theta), B(\theta), C(\theta))$ . The estimate  $\hat{\theta}$  is obtained by minimizing this criterion.

The estimate  $\hat{\theta}$  is based on observations of the inputs  $u$  and the outputs  $y$ , and since any system  $(TA_0T^{-1}, TB_0, C_0T^{-1})$  exhibits the same input-output behavior as (3.9), a model  $(\hat{A}, \hat{B}, \hat{C})$  is not unique. This nonuniqueness can cause problems in the Prediction Error Method, since it cannot distinguish between different models. The identification criterion is not unimodal (Van den Bosch and Van der Klauw, 1994), since it has several global minima.

The nonuniqueness problem can be solved by introducing constraints on the model structure, thereby creating *uniquely identifiable* parametrizations.

A parametrization is uniquely identifiable if equivalence in the input-output behavior implies equivalence in the parameter vector:

$$G(z, \theta_1) = G(z, \theta_2) \Rightarrow \theta_1 = \theta_2 \quad (3.10)$$

Hence, to make the parameter estimation problem uniquely solvable, a uniquely identifiable parametrization is needed.

Two types of uniquely identifiable parametrizations can be distinguished in literature: *canonical* and *overlapping*.

The set of transfer function matrices of McMillan degree  $n$  and given  $m$  and  $p$  can be divided into a finite number of disjoint subsets, each of which is characterized by a set of structure indices. Each subset is a canonical parametrization. The number of parameters, needed to describe the input-output behavior, is minimal.

Procedures to select a canonical parametrization have been described by Denham (1974), Guidorzi (1975, 1981), and by El-Sherief and Sinha (1979).

The disadvantage of canonical structures is their lack of flexibility. Once a parametrization has been chosen, one cannot switch to another without losing all the effort already put into the identification. This is a problem if a wrong structure has been selected.

The lack of flexibility of canonical structures has resulted in the development of overlapping or *pseudo-canonical* parametrizations (Glover and Willems, 1974; Guidorzi and Beghelli, 1982; Guidorzi *et al.*, 1982; Van Overbeek and Ljung, 1982; Corrêa and Glover, 1982, 1984a/b; Gevers and Tsoi, 1984; Gevers and Wertz, 1984; Beghelli *et al.*, 1987). Again the set of transfer function matrices of McMillan degree  $n$  and given  $m$  and  $p$  can be divided into a finite number of subsets, but now these subsets are overlapping. Different parametrizations are related by a basis transformation in the state space, and hence one can switch from one parametrization to the other, without losing the information obtained up to then.

If a system cannot be represented within a given parametrization, the transformation into that parametrization is singular. If a model of that system is identified within this parametrization, the parameter estimation problem is ill conditioned. Hence the need to

select not only a uniquely identifiable parametrization, but a parametrization within which the system can be represented.

The flexibility of overlapping parametrizations is exploited by Van Overbeek and Ljung (1982), who propose an algorithm that switches on-line from one parametrization to another, whenever it is detected that the conditioning of the parameter estimation problem crosses some bound. To keep track of the conditioning, a matrix is computed that is guaranteed to have a larger condition number than the Hessian of the identification criterion. This is done, because it is too time-consuming to compute the Hessian at every time step.

However, for off-line identification, a parametrization can be selected on the basis of the complete data set. Hence we do not need a complex algorithm to keep track of the condition number of the Hessian of the identification criterion. In the next section a procedure is proposed to select a suitable parametrization.

### 3.4.2 Model structure selection procedure

Consider a process, described by (3.9). From the state space representation, the unique Markov parameters  $H_i$  can be calculated.

$$H_i = C_0 A_0^{i-1} B_0 \quad i = 1, 2, \dots \quad (3.11)$$

The input-output behavior of the process is characterized by these Markov parameters, which are also known as the impulse response matrices, since

$$w_t = \sum_{i=1}^{\infty} H_i u_{t-i}. \quad (3.12)$$

Since the process is stable,  $H_i$  tends to zero for large  $i$ .

The Markov parameters can be collected in the Hankel matrix  $\mathcal{H}_{N,\infty}$ , with  $N$  a finite but large number ( $N > n$ ):

$$\mathcal{H}_{N,\infty} = \begin{bmatrix} H_1 & H_2 & H_3 & \cdots \\ H_2 & H_3 & H_4 & \cdots \\ H_3 & H_4 & H_5 & \cdots \\ \vdots & \vdots & \vdots & \\ H_N & H_{N+1} & H_{N+2} & \cdots \end{bmatrix}. \quad (3.13)$$

Since (3.9) is minimal,  $n$  is the minimum dimension of the state vector, and therefore (Ho and Kalman, 1966)

$$\text{rank } \mathcal{H}_{N,\infty} = n \quad \text{if } N \geq n. \quad (3.14)$$

Each Markov parameter  $H_i$  is of dimension  $p \times m$ . Row  $j$  ( $1 \leq j \leq p$ ) of  $H_i$  is associated with output  $j$ . Consequently, the rows of the Hankel matrix  $\mathcal{H}_{N,\infty}$  that are associated with output  $j$  have indices  $j, j + p, j + 2p, \dots, N - p + j$ .

If  $N$  is large enough, equality holds in (3.14), and it is possible to extract  $n$  independent rows of  $\mathcal{H}_{N,\infty}$  and reconstruct all Markov parameters from a finite portion of these rows (Glover and Willems, 1974).

Since each row of  $\mathcal{H}_{N,\infty}$  is associated with an output, the selection of  $n$  independent rows of  $\mathcal{H}_{N,\infty}$  corresponds to the selection of  $n$  independent output components.

To each basis selection a multi-index  $\mathcal{I} = \{i_1, \dots, i_n\}$  is associated, where the numbers  $i_1, \dots, i_n$ , arranged in increasing order, are the indices of the rows of  $\mathcal{H}_{N,\infty}$  that form the basis.

Of course, there are a large number of possible selections. In general, some selection rules apply, which reduces the number of possible selections. We only consider *nice* selections:

**Definition 3.1 (Gevers and Wertz, 1984)** A multi-index  $\mathcal{I} = \{i_1, \dots, i_n\}$  defining  $n$  independent rows of  $\mathcal{H}_{N,\infty}$  is called *nice* if it fulfills the following two conditions:

1.  $1, 2, \dots, p \in \mathcal{I}$ ,
2. if  $j \in \mathcal{I}, j > p$ , then  $j - p \in \mathcal{I}$ .

Definition 3.1 is equivalent to the selection rules introduced by Van Overbeek and Ljung (1982), and are sometimes called the *block selection rule* (1) and the *chain selection rule* (2) (Gevers and Tsoi, 1984).

**Example 3.1** Suppose that in a nice selection the multi-index is  $\mathcal{I} = \{1, 2, \dots, p, p + 1\}$ . Then the selected rows, associated with output  $j$ , are 1 and 2 for output 1, and 1 for the other outputs. △

For a nice selection, it is sufficient to know the number of rows selected per output. Therefore a model structure  $s = (r_1, r_2, \dots, r_p)$  only contains the integers  $r_j$ , indicating that the first  $r_j$  rows, associated with output  $j$ , are selected. The numbers  $r_j$  are called the *structure indices*.



**Example 3.2** The model structure for the multi-index  $\mathcal{I} = \{1, 2, \dots, p, p+1\}$  is  $s = (2, 1, \dots, 1)$ .  $\triangle$

Note that, since only nice selections are used, the structure indices are at least equal to one:  $r_j \geq 1$  for  $j = 1, \dots, p$ .

The total order  $n$  of the model is

$$n = \sum_{j=1}^{\ell} r_j. \quad (3.15)$$

**Remark 3.2** The *Kronecker invariants* (Kailath, 1980) are also known as the *canonical observability indices* (Guidorzi, 1975). The selected rows are the first  $n$  independent rows of  $\mathcal{H}_{N,\infty}$ .

Overlapping model structures are related by a coordinate transformation of the state vector. The similarity transformation  $T$  to obtain the structure  $(r_1, r_2, \dots, r_p)$  is given by

$$T = \begin{bmatrix} c_1 & A'c_1 & \cdots & [A^{r_1-1}]'c_1 & c_2 & \cdots & [A^{r_p-1}]'c_p \end{bmatrix} \quad (3.16)$$

where  $c_i'$  is the  $i$ -th row of matrix  $C$ .

If  $T$  is singular for a certain selection of indices, the system cannot be represented within that parametrization. The associated parameter estimation problem is then ill conditioned, and a different parametrization should be chosen.

The identification problem can now be formulated as a combined parameter estimation and model structure selection problem:

$$(\hat{\theta}, s^*) = \arg \min_{\substack{\theta \in \Theta \\ s \in \mathbb{N}^p}} V_N(\theta, s). \quad (3.17)$$

Because of the integer-valued  $s$ , (3.17) is hard to solve (except for linear parametrizations). A PEM identification should be done for each possible  $s$ , and the results should be evaluated to show which pair of  $(\hat{\theta}, s)$  minimizes (3.17). This procedure carries a heavy computational load.

Therefore we propose a procedure that might not give the optimal structure in the sense that  $V_N(\hat{\theta}, s^*)$  is minimal, but that provides a suitable model structure, which needs fewer computations (Van der Kuauw and Van den Bosch, 1993).

First observe that although solving (3.17) needs a lot of computations for nonlinear parametrizations, it can be done rather fast for linear parametrizations, since the PEM estimate  $\hat{\theta}$  can then be calculated analytically. However, the optimal model structure for an ARX model is not necessarily the optimal structure for an OE model, since, in the first case, the noise has an influence on the estimate.

To circumvent this problem, first  $p$  high order MISO OE models are identified, for each output. With these models, noise-free outputs  $y^u$  can be reconstructed. If we now apply MIMO ARX identification to the data set  $\{y_t^u, u_t\}$ , the noise no longer influences the model, and a model structure suitable for the ARX model is suitable for the OE model as well. Different models can now be calculated analytically for different sets of structure indices. These models can be evaluated using Akaike's Information Criterion (AIC) or Final Prediction Error (FPE), as described by, e.g., Ljung (1987). These criteria weigh the number of parameters in the identification criterion, such that a larger model order is penalized.

The resulting model structure is used to estimate a MIMO OE model (in a state space representation). This estimation can be initialized by the MIMO ARX model, corresponding to the selected model structure.

The procedure is summarized in the following algorithm.

**Algorithm 3.2 (Model structure selection algorithm)** *The joint problem of parameter estimation and model structure selection can be solved in several steps:*

1. For each output  $j$  ( $j = 1, \dots, p$ ), estimate high order MISO OE models  $\hat{\theta}_j$ :

$$\hat{\theta}_j = \arg \min_{\theta \in \Theta} \frac{1}{N} \sum_{t=1}^N (y_{j,t} - \hat{y}_{j,t}(\theta))^2 \quad j = 1, \dots, p \quad (3.18)$$

with

$$\hat{y}_{j,t} = G_j(\hat{\theta}_j)u_t. \quad (3.19)$$

2. Reconstruct noise-free outputs  $y_{j,t}^u$  with these models and the measured inputs  $u$ :

$$y_{j,t}^u = G_j(\hat{\theta}_j)u_t \quad , \quad y_t^u = \begin{pmatrix} y_{1,t}^u & \dots & y_{p,t}^u \end{pmatrix}' \quad (3.20)$$

3. Determine MIMO ARX models from the data set  $\{y_t^u, u_t\}_N$ , for each model structure to be investigated, and choose the one that minimizes the FPE (or AIC):

$$(\theta_{\text{init}}, s^*) = \arg \min_{\substack{\theta \in \Theta \\ s \in \mathbb{N}^p}} \text{FPE}(A(\theta, s)y_t^u - B(\theta, s)u_t) \quad (3.21)$$

where  $A$  and  $B$  are the polynomial matrices of an ARX model.

The estimate  $A^{-1}(\theta_{\text{init}}, s^*)B(\theta_{\text{init}}, s^*)$  is the initial estimate for the OE identification in the next step.

4. Estimate a MIMO OE model with the selected structure  $s^*$  and initial model  $\theta_{\text{init}}$ :

$$\hat{\theta} = \arg \min_{\theta \in \Theta} V_N(\theta, s^*). \quad (3.22)$$

### 3.4.3 Simulation example

To illustrate the proposed model structure selection procedure, Algorithm 3.2 is applied to data from the following system (see also El-Sherief and Sinha, 1979).

$$\begin{aligned} A &= \begin{bmatrix} 0 & 1 & 0 & 0 \\ -0.1 & 0.65 & 0 & 0 \\ 0 & 0 & 0 & 1 \\ -2/3 & 5/3 & -0.25 & 1 \end{bmatrix} & B &= \begin{bmatrix} 0 & 2 \\ 0.25 & 0.8 \\ 0 & 0 \\ 1 & 1 \end{bmatrix} \\ C &= \begin{bmatrix} 1 & 0 & 0 & 0 \\ 0 & 0 & 1 & 0 \end{bmatrix}. \end{aligned} \quad (3.23)$$

Data is generated with (3.23) with an S/N-ratio of 10 dB per output. The number of data is  $N = 3000$ .

Theoretically, the valid model structures of (3.23) are: (2, 2) and (1, 3). For the model structure (3, 1) the transformation matrix  $T$  in (3.16) is singular.

Two different model structure selection procedures are applied. First a model structure is selected by estimating MIMO ARX models of different structures from the original data (step 3 of Algorithm 3.2). Then a model structure is selected with Algorithm 3.2. The first method is faster, but it will be shown that Algorithm 3.2 gives a better result.

#### MIMO ARX model structure selection

MIMO ARX models are identified for different model structures. These models are calculated analytically with a PEM.

The structure index of each output is varied between 1 and 4, resulting in 16 combinations, and 16 MIMO ARX models, with corresponding value of the FPE criterion. These values are shown in Figure 3.1a as a function of the model order  $n$  (sum of the structure indices). Judging from Figure 3.1, the selected model order will be 5. This is known to be incorrect.

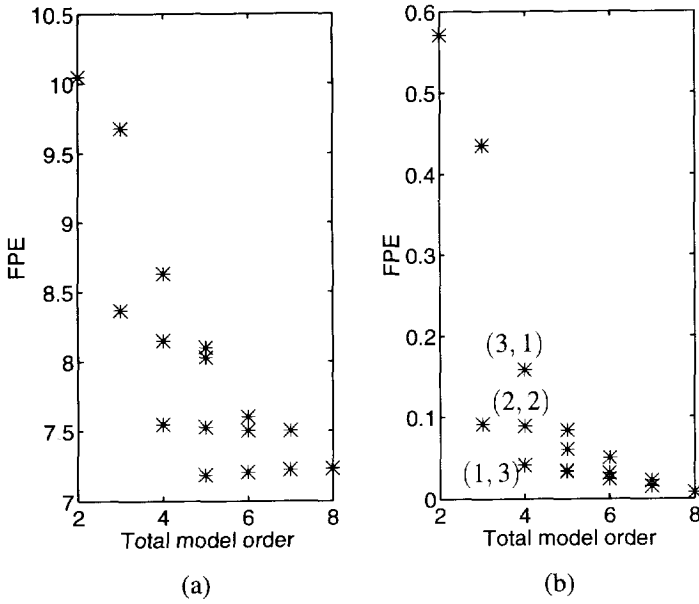

Figure 3.1. FPE criterion versus the model order  $n$  for a) MIMO ARX selection and b) Algorithm 3.2

### Algorithm 3.2

In accordance with (3.18), 2 MISO OE models are estimated. Their order is 4 (selected with the aid of MATLAB's `ivstruc` command). The noise-free outputs  $y_t^u$  (3.20) are calculated, and the FPE criterion (3.21) is calculated for the same 16 model structures as before. The values of the FPE criterion are shown in Figure 3.1b as a function of the model order  $n$ . From this figure we select the (1, 3)-structure. This is known to be correct.

Note that the incorrect (3, 1)-structure gives the highest value of the FPE criterion for  $n = 4$ .

Comparing both model structure selection algorithms, we see that Algorithm 3.2 gives a correct model structure, whereas the faster procedure without the intermediate MISO OE identification step yields a structure of too high an order.

## 3.5 Lattice algorithms for on-line SISO identification

### 3.5.1 Introduction

With the development of adaptive control, there has been a growing interest in on-line or recursive identification (e.g., Åström, 1989). This has resulted in the development of a number of algorithms, such as the Recursive Prediction Error Method (RPEM) (Ljung and Söderström, 1983), that provide a model that is updated as soon as a new measurement becomes available.

RPEM is obtained by rewriting the nonrecursive PEM algorithm. There are several possible implementations of RPEM. One implementation is used in Matlab's System Identification Toolbox (Ljung, 1993). Another possibility is the use of *lattice* algorithms. These algorithms are obtained by orthogonalization of the regressor space through Levinson's algorithm (Levinson, 1947). They are fast, numerically robust, and they provide models of several orders simultaneously. If a model of order  $M$  is estimated, we immediately obtain models of order  $1, 2, \dots, M - 1$  as well. This makes it possible to choose the model order on line.

Because of their numerical behavior, lattice algorithms are interesting alternatives for off-line identification as well.

Until now, lattice algorithms were mainly used in signal processing, since they were developed for AR, ARX and ARMA models only (Friedlander, 1983; Gevers and Wertz, 1983; Lee *et al.*, 1981, 1982; Makhoul, 1977; Morf *et al.*, 1977, 1978, 1979). Application in adaptive control was therefore restricted to ARX models (Goodwin and Sin, 1984; Yang and Huang, 1992).

Recently, these algorithms have been extended to more general SISO model structures (Polat, 1992; Van der Klauw *et al.*, 1993, 1994a). This chapter is based on these results. The extension to multivariable systems is currently under investigation.

First a brief overview of RPEM is given. Then, in Section 3.5.3, the orthogonalization of the regressor space is discussed. The lattice algorithm for general model structures is presented in Section 3.5.4, and in Section 3.5.5 some simplifications are proposed for specific parametrizations.

Convergence of the lattice algorithm for ARMAX model structures is proven in Section 3.5.6, and some simulation examples in Section 3.5.7 illustrate the advantages of the lattice algorithms. Finally, in Section 3.5.8, we discuss how the algorithms could be used for on-line closed-loop identification.

### 3.5.2 Recursive identification

Consider the following general Linear Time-Invariant strictly proper SISO model structure, with parameter vector  $\theta$ .

$$A(q^{-1}, \theta)y_t = \frac{B(q^{-1}, \theta)}{F(q^{-1}, \theta)}u_t + \frac{C(q^{-1}, \theta)}{D(q^{-1}, \theta)}e_t \quad (3.24)$$

with  $A, B, F, C$  and  $D \in \mathbb{R}[z^{-1}]$ , with order  $n$  and coefficients  $a_j, b_j, f_j, c_j$  and  $d_j$ ,  $j = 0 \dots n$ . Moreover,  $A, F, C$  and  $D$  are monic ( $a_0 = f_0 = c_0 = d_0 = 1$ ), and  $B$  has zero first element ( $b_0 = 0$ ). The number of polynomials in a model is denoted by  $\alpha$  ( $\alpha = 5$  in (3.24)), and the parameter vector  $\theta \in \mathbb{R}^{\alpha n}$  is defined as

$$\theta = \left( a_1 \ b_1 \ f_1 \ c_1 \ d_1 \ \dots \ a_n \ b_n \ f_n \ c_n \ d_n \right)'. \quad (3.25)$$

Since  $\theta$  is estimated recursively, the estimate has a time index  $t$ . The estimated polynomials have a time index as well, and are denoted by  $\hat{A}_t = A(\hat{\theta}_t)$ , etc.

We define the prediction error  $\varepsilon_t(\hat{\theta}_{t-1})$  as

$$\varepsilon_t \triangleq \varepsilon_t(\hat{\theta}_{t-1}) = y_t - \hat{y}_t(\hat{\theta}_{t-1})$$

where  $\hat{y}_t(\hat{\theta}_{t-1})$  is the one-step-ahead prediction of  $y_t$ , based on the model, obtained in the previous step.

If  $\varepsilon_t$  is calculated from  $\hat{\theta}_t$ , it is called the residual error, denoted by  $\bar{\varepsilon}_t$ .

$$\bar{\varepsilon}_t \triangleq \bar{\varepsilon}_t(\hat{\theta}_t) = y_t - \hat{y}_t(\hat{\theta}_t). \quad (3.26)$$

**Remark 3.3** For nonrecursive identification algorithms, the prediction error  $\varepsilon$  and the residual error  $\bar{\varepsilon}$  are equal.

To write  $\hat{y}_t$  in a regression form (Ljung, 1987), we introduce the following auxiliary signals.

$$\begin{aligned} w_t(\hat{\theta}_{t-1}) &= \frac{\hat{B}_{t-1}}{\hat{F}_{t-1}} u_t \\ v_t(\hat{\theta}_{t-1}) &= \hat{A}_{t-1} y_t - w_t(\hat{\theta}_{t-1}). \end{aligned}$$

The data, from which the model is built, is collected in the *data vector*  $z_t$ :

$$z_t \triangleq z_t(\hat{\theta}_{t-1}) = \left( -y_t \quad u_t \quad -w_t(\hat{\theta}_{t-1}) \quad \varepsilon_t(\hat{\theta}_{t-1}) \quad -v_t(\hat{\theta}_{t-1}) \right)'. \quad (3.27)$$

A model of order  $i$  is estimated from the data vectors in the previous  $i$  steps, collected in the  $i$ th-order *regression vector*  $\phi_{i,t}$ :

$$\phi_{i,t} = \left( z'_{t-1} \quad \cdots \quad z'_{t-i} \right)' \quad (3.28)$$

of dimension  $\alpha i \times 1$ . Note that  $\phi_{i,t}$  depends on  $\hat{\theta}_{t-1}$ .

If we define the  $i$ th-order parameter vector  $\theta_i$  as

$$\theta_i = \left( a_1 \quad b_1 \quad f_1 \quad c_1 \quad d_1 \quad \cdots \quad a_i \quad b_i \quad f_i \quad c_i \quad d_i \right)', \quad (3.29)$$

the  $i$ th-order one-step-ahead prediction  $\hat{y}_{i,t}(\hat{\theta}_{i,t-1})$  is

$$\hat{y}_{i,t}(\hat{\theta}_{i,t-1}) = \phi'_{i,t} \hat{\theta}_{i,t-1}.$$

**Remark 3.4** In most references the subscript  $i$  is not used, because the models are always of one specific order. We mention the order explicitly, because later the lattice algorithms will be recursive in order.

Ljung and Söderström (1983) derive a recursive algorithm to estimate  $\theta_i$  with a PEM. For comprehensibility, we briefly review the essence of this derivation.

The estimate  $\hat{\theta}_{i,t}$  is obtained by minimizing the PEM criterion  $V_t(\theta)$ :

$$\hat{\theta}_{i,t} = \arg \min_{\theta \in \Theta} V_t(\theta) \quad (3.30a)$$

$$V_t(\theta) = \sum_{k=1}^t \lambda^{t-k} \varepsilon_k^2(\theta) \quad (3.30b)$$

where  $\lambda$  is the forgetting factor ( $0 < \lambda \leq 1$ ).

The use of  $\lambda$  in (3.30b) results in an *exponential forgetting profile*, where older data is given less weight than newer data.

A Taylor expansion of  $V_t(\theta)$  around  $\hat{\theta}_{i,t-1}$  yields

$$\begin{aligned} V_t(\theta) &= V_t(\hat{\theta}_{i,t-1}) + V_{\theta,t}(\hat{\theta}_{i,t-1}) [\theta - \hat{\theta}_{i,t-1}] \\ &\quad + \frac{1}{2} [\theta - \hat{\theta}_{i,t-1}]' V_{\theta\theta,t}(\hat{\theta}_{i,t-1}) [\theta - \hat{\theta}_{i,t-1}] + o(|\theta - \hat{\theta}_{i,t-1}|^2) \end{aligned} \quad (3.31)$$

where  $V_{\theta,t}(\hat{\theta}_{i,t-1})$  is the derivative of  $V_t$  with respect to  $\theta$  (Appendix A), evaluated in  $\theta = \hat{\theta}_{i,t-1}$ ,  $V_{\theta\theta}$  is the Hessian, and  $o(x)$  is a function such that  $o(x)/|x| \rightarrow 0$  as  $|x| \rightarrow 0$ .

Minimization of (3.31) with respect to  $\theta$  gives

$$\hat{\theta}_{i,t} = \hat{\theta}_{i,t-1} - [V_{\theta\theta,t}(\hat{\theta}_{i,t-1})]^{-1} [V_{\theta,t}(\hat{\theta}_{i,t-1})]' + o(|\theta - \hat{\theta}_{i,t-1}|). \quad (3.32)$$

Recursive expressions for  $V_\theta$  and  $V_{\theta\theta}$  are derived by introducing the gradient  $\psi_t(\theta)$ , which is the negative derivative of  $\varepsilon_t(\theta)$  with respect to  $\theta$ , and which is defined as a column vector:

$$\psi_t(\theta) = \left[ -\frac{\partial}{\partial \theta} \varepsilon_t(\theta) \right]'. \quad (3.33)$$

Differentiating (3.30b) with respect to  $\theta$  we obtain

$$[V_{\theta,t}(\theta)]' = - \sum_{k=1}^t \lambda^{t-k} \psi_k(\theta) \varepsilon_k(\theta) = \lambda [V_{\theta,t-1}(\theta)]' - \psi_t(\theta) \varepsilon_t(\theta) \quad (3.34)$$

and differentiating once more yields

$$V_{\theta\theta,t}(\theta) = \lambda V_{\theta\theta,t-1}(\theta) + \psi_t(\theta) \psi_t'(\theta) + \frac{\partial^2 \varepsilon_t(\theta)}{\partial \theta^2} \varepsilon_t(\theta). \quad (3.35)$$

A number of approximations are then introduced.



- It is assumed that  $\hat{\theta}_{i,t}$  is to be found in a small neighborhood of  $\hat{\theta}_{i,t-1}$ , which is reasonable if  $t$  is large. In that case

$$o(|\theta - \hat{\theta}_{i,t-1}|) = 0 \quad (3.36)$$

and

$$V_{\theta\theta,t}(\hat{\theta}_{i,t}) = V_{\theta\theta,t}(\hat{\theta}_{i,t-1}). \quad (3.37)$$

- It is assumed that  $\hat{\theta}_{i,t-1}$  is indeed the optimal estimate at time  $t - 1$ , so that

$$V_{\theta,t-1}(\hat{\theta}_{i,t-1}) = 0. \quad (3.38)$$

- It is assumed that

$$\frac{\partial^2 \varepsilon_t}{\partial \theta^2}(\hat{\theta}_{i,t-1}) \varepsilon_t(\hat{\theta}_{i,t-1}) = 0 \quad (3.39)$$

or at least that its contribution to  $V_{\theta\theta,t}$  in (3.34) is an order of magnitude less than the second term.

Inserting the assumptions (3.38) and (3.39) into (3.34), and denoting by  $R_{i,t}$  an approximation of  $V_{\theta\theta,t}(\hat{\theta}_{i,t-1})$ , we obtain

$$R_{i,t} = \lambda R_{i,t-1} + \psi_t(\hat{\theta}_{i,t-1}) \psi_t'(\hat{\theta}_{i,t-1}). \quad (3.40)$$

Inserting assumption (3.38) into (3.35), we obtain

$$\begin{aligned} [V_{\theta,t}(\hat{\theta}_{i,t-1})]' &= \lambda [V_{\theta,t-1}(\hat{\theta}_{i,t-1})]' - \psi_t(\hat{\theta}_{i,t-1}) \varepsilon_t(\hat{\theta}_{i,t-1}) \\ &= -\psi_t(\hat{\theta}_{i,t-1}) \varepsilon_t(\hat{\theta}_{i,t-1}). \end{aligned} \quad (3.41)$$

Using these equations and assumption (3.36) in (3.32), we have

$$\hat{\theta}_{i,t} = \hat{\theta}_{i,t-1} + R_{i,t}^{-1} \psi(\hat{\theta}_{i,t-1}) \varepsilon_t(\hat{\theta}_{i,t-1}) \quad (3.42)$$

which is the general recursive equation for estimating  $\theta_i$ .

To calculate  $\hat{\theta}_i$  and  $R_i$ , the gradient  $\psi$  must be computed. Söderström and Ljung (1983, pp. 113/114) show that it consists of filtered versions of  $y$ ,  $u$ ,  $w$ ,  $\varepsilon$  and  $v$ :

$$\begin{aligned}\tilde{y}_t(\hat{\theta}_{t-1}) &= \frac{\hat{D}_{t-1}}{\hat{C}_{t-1}} y_t \\ \tilde{u}_t(\hat{\theta}_{t-1}) &= \frac{\hat{D}_{t-1}}{\hat{C}_{t-1} \hat{F}_{t-1}} u_t \\ \tilde{w}_t(\hat{\theta}_{t-1}) &= \frac{\hat{D}_{t-1}}{\hat{C}_{t-1} \hat{F}_{t-1}} w_t(\hat{\theta}_{t-1}) \\ \tilde{\varepsilon}_t(\hat{\theta}_{t-1}) &= \frac{1}{\hat{C}_{t-1}} \varepsilon_t(\hat{\theta}_{t-1}) \\ \tilde{v}_t(\hat{\theta}_{t-1}) &= \frac{1}{\hat{C}_{t-1}} v_t(\hat{\theta}_{t-1}).\end{aligned}$$

These filtered signals are calculated from  $\hat{\theta}_{i,t-1}$ , and are collected in the *filtered data vector*  $\tilde{z}_{i,t}$

$$\tilde{z}_{i,t} = \left( -\tilde{y}_t(\hat{\theta}_{t-1}) \quad \tilde{u}_t(\hat{\theta}_{t-1}) \quad -\tilde{w}_t(\hat{\theta}_{t-1}) \quad \tilde{\varepsilon}_t(\hat{\theta}_{t-1}) \quad -\tilde{v}_t(\hat{\theta}_{t-1}) \right)' \quad (3.43)$$

and the gradient vector is built from the last  $i$  filtered data vectors:

$$\psi_{i,t} = \left( \tilde{z}'_{i,t-1} \quad \cdots \quad \tilde{z}'_{i,t-i} \right)'$$

Then the covariance matrix  $R_{i,t}$  is given by

$$R_{i,t} = \sum_{k=1}^t \lambda^{t-k} \psi_{i,k} \psi'_{i,k} \quad (3.44)$$

which is equivalent to (3.40).

To summarize, the recursive estimation of  $\theta_i$  is done with (3.42), which is obtained from rewriting the nonrecursive PEM (3.30) in a recursive form.

### 3.5.3 Orthogonalization of the regressor space

If the model order is increased by one, the data vector  $z_{t-i-1}$  is added to  $\phi_{i,t}$  (3.28), and the parameters  $a_{i+1}, \dots, d_{i+1}$  are added to the parameter vector  $\theta_i$  (3.29). In general,

this implies that the complete parameter vector  $\theta_{i+1}$  is re-estimated;  $\hat{\theta}_i$  is not a part of  $\hat{\theta}_{i+1}$ , because the data vector  $z_{t-i-1}$  carries information about the parameters in  $\hat{\theta}_i$  as well. Hence  $\phi_{i+1,t}$  is not an orthogonal basis in the regressor space.

Levinson's algorithm (1947) can be used to orthogonalize the regressor space. Residual errors are defined that form an orthogonal basis, such that each additional residual error carries information about the additional parameters only. This approach is taken by Ljung and Söderström (1983) and by Ljung (1987) to derive lattice algorithms for AR models.

This section is based on the results of Polat (1992) and Van der Klauw *et al.* (1993, 1994a), who derive lattice algorithms for the general model structure (3.24).

The orthogonalization is based on the following lemma. Its proof is given by Gevers and Wertz (1983) for ARMA models, and by Polat (1992) for general model structures.

**Lemma 3.1** *There exist unique time-dependent matrices  $\Theta_{i,t}^e$ ,  $\Theta_{i,t}^r$ ,  $R_{i,t}^e$  and  $R_{i,t}^r$ , such that*

$$R_{i+1,t+1} \begin{bmatrix} I_\alpha \\ \Theta_{i,t}^e \end{bmatrix} = \begin{bmatrix} R_{i,t}^e \\ 0_{i\alpha \times \alpha} \end{bmatrix} \tag{3.45a}$$

$$R_{i+1,t+1} \begin{bmatrix} \Theta_{i,t}^r \\ I_\alpha \end{bmatrix} = \begin{bmatrix} 0_{i\alpha \times \alpha} \\ R_{i,t}^r \end{bmatrix} \tag{3.45b}$$

where  $R_{i,t}$  is defined by (3.44).

Polat (1992) shows that the matrices  $\Theta_i^e$  and  $\Theta_i^r$  can be interpreted as the parameters of the following forward and backward models, respectively.

$$\hat{z}_{i,t} = -\Theta_{i,t}^e \psi_{i,t} \tag{3.46a}$$

$$\hat{z}_{i,t-i} = -\Theta_{i,t}^r \psi_{i,t+1} \tag{3.46b}$$

where  $\hat{z}$  denotes the prediction of the filtered data vector.

It follows from (3.46a) and the definition of  $\hat{z}_{i,t}$  in (3.43) that the parameter vector  $\hat{\theta}_{i,t}$  is the first column of  $\Theta_{i,t}^e$ .

The forward residuals  $\bar{e}_{i,t}$  and the backward residuals  $\bar{r}_{i,t}$  are defined as

$$\begin{aligned} \bar{e}_{i,t} &= \tilde{z}_{i,t} + \Theta_{i,t}^e \psi_{i,t} \\ \bar{r}_{i,t} &= \tilde{z}_{i,t-i} + \Theta_{i,t}^r \psi_{i,t+1}. \end{aligned}$$

The backward residuals form an orthogonal basis in the sense that

$$\frac{1}{N} \sum_{t=1}^N \bar{r}_{n,t} \bar{r}'_{k,t} \begin{cases} \geq 0 & , n = k \\ = 0_{\alpha \times \alpha} & , n \neq k \end{cases} \tag{3.47}$$

It will be shown later that  $\hat{y}_t$  can be calculated from these residuals.

The orthogonality property (3.47) ensures that if an  $n$ th order model is estimated, all lower order models are produced as a by-product.

If  $\hat{y}$  can be calculated from  $\bar{r}$ , so can  $\varepsilon$ ,  $v$  and  $w$ . Thus we can derive fast recursive algorithms to estimate  $\hat{\theta}_i$  and all lower order models.

Before presenting these algorithms in the following sections, we need some more definitions and relationships, to establish the relationship between  $\hat{y}$ ,  $\bar{r}$  and the lattice parameter vector, which is defined later.

The forward prediction errors  $e_{i,t}$  and the backward prediction errors  $r_{i,t}$  are defined as

$$\begin{aligned} e_{i,t} &= \tilde{z}_t + \Theta_{i,t-1}^e \psi_{i,t} \\ r_{i,t} &= \tilde{z}_{t-i} + \Theta_{i,t-1}^r \psi_{i,t+1}. \end{aligned}$$

The relationship between forward and backward residuals and prediction errors is

$$\bar{e}_{i,t} = (1 - \beta_{i,t}) e_{i,t} \quad (3.48a)$$

$$\bar{r}_{i,t} = (1 - \beta_{i,t+1}) r_{i,t} \quad (3.48b)$$

with

$$\beta_{i,t} = \psi_{i,t}' [R_{i,t-1}^r]^{-1} \psi_{i,t}.$$

The matrices  $R_{i,t}^e$  and  $R_{i,t}^r$  in lemma 3.1 are the cross-covariance matrices of the forward and backward residuals and prediction errors, respectively:

$$R_{i,t}^e = \sum_{k=1}^t \lambda^{t-k} \bar{e}_{i,k} e_{i,k}' = \lambda R_{i,t-1}^e + (1 - \beta_{i,t}) e_{i,t} e_{i,t}' \quad (3.49a)$$

$$R_{i,t}^r = \sum_{k=1}^t \lambda^{t-k} \bar{r}_{i,k} r_{i,k}' = \lambda R_{i,t-1}^r + (1 - \beta_{i,t+1}) r_{i,t} r_{i,t}'. \quad (3.49b)$$

Direct application of (3.45a) and (3.45b) yields equations for  $\Theta_{i,t}^e$  and  $\Theta_{i,t}^r$ , recursive in time and order.

$$\Theta_{i,t}^e = \begin{bmatrix} \Theta_{i-1,t}^e \\ 0_{\alpha \times \alpha} \end{bmatrix} - \begin{bmatrix} \Theta_{i-1,t-1}^r \\ I_\alpha \end{bmatrix} K_{i-1,t}^e \quad (3.50a)$$

$$\Theta_{i,t}^r = \begin{bmatrix} 0_{\alpha \times \alpha} \\ \Theta_{i-1,t-1}^r \end{bmatrix} - \begin{bmatrix} I_\alpha \\ \Theta_{i-1,t}^e \end{bmatrix} K_{i-1,t}^r \quad (3.50b)$$

with the forward reflection coefficient matrix  $K_{i,t}^e$  and the backward reflection coefficient matrix  $K_{i,t}^r$  defined as

$$K_{i,t}^e = F_{i,t}' [R_{i,t-1}^r]^{-1} \quad (3.51a)$$

$$K_{i,t}^r = F_{i,t} [R_{i,t}^e]^{-1} \quad (3.51b)$$

with  $F_{i,t}$  the cross-covariance matrix of the backward residual and forward prediction errors:

$$F_{i,t} = \lambda F_{i,t-1} + \bar{r}_{i,t-1} e_{i,t}' = \lambda F_{i,t-1} + (1 - \beta_{i,t}) r_{i,t-1} e_{i,t}' \quad (3.52)$$

The forward reflection coefficient matrices  $K_i^e$  play the role of the parameter vector in lattice algorithms.

Note that

$$\hat{z}_{i,t} = \sum_{j=1}^i K_{j,t-1}^e \bar{r}_{j,t-1}, \quad i = 1, 2, \dots, n.$$

A prediction  $\hat{y}_t$  of  $y_t$  is obtained by taking the first element of  $\hat{z}_{i,t}$ . Defining  $\eta$  as an  $\alpha \times 1$  vector:  $\eta = (-1 \ 0 \ \dots \ 0)'$ , we have, for  $i = 1, 2, \dots, n$ :

$$\hat{y}_{i,t} = \eta' \hat{z}_{i,t} = \sum_{j=1}^i \eta' K_{j,t-1}^e \bar{r}_{j,t-1}. \quad (3.53)$$

Recalling that the backward residuals form an orthogonal basis in the regressor space, the lattice regressor  $\varphi_{i,t}$  is defined as

$$\varphi_{i,t} = (\bar{r}_{1,t-1}' \ \bar{r}_{2,t-1}' \ \dots \ \bar{r}_{i,t-1}' )'. \quad (3.54)$$

Defining the lattice parameter vector  $\vartheta_{i,t}$  as

$$\vartheta_{i,t} = [K_{1,t}^e \ K_{2,t}^e \ \dots \ K_{i,t}^e]' \eta \quad (3.55)$$

the prediction (3.53) becomes:

$$\hat{y}_{i,t} = \hat{\vartheta}_{i,t-1}' \varphi_{i,t} = \hat{y}_{i,t}(\hat{\vartheta}_{i,t-1}). \quad (3.56)$$

Equations (3.54)–(3.56) illustrate that  $\hat{y}_t(\hat{\theta}_{t-1}) = \hat{y}_t(\hat{\vartheta}_{t-1})$  is computed from the forward reflection coefficient matrices  $K_{i,t-1}^e$  and the backward residuals  $\bar{r}_{i,t}$ . Hence our definition of the lattice parameter vector (3.55) and the lattice regressor (3.54).

The implementation of the derived expressions results in a general lattice algorithm, which is presented in the next section. Simplifications for less general model structures than (3.24) yield simplified lattice algorithms.

### 3.5.4 General lattice algorithms

To implement the recursive lattice identification algorithms, recursive expressions are required for all variables that need to be calculated on line. The forward and backward prediction errors are calculated as

$$e_{i,t} = e_{i-1,t} - K_{i-1,t-1}^e r_{i-1,t-1} \quad (3.57a)$$

$$r_{i,t} = r_{i-1,t-1} - K_{i-1,t-1}^r e_{i-1,t}. \quad (3.57b)$$

For the forward and backward residual errors we obtain

$$\bar{e}_{i,t} = \bar{e}_{i-1,t} - K_{i-1,t}^e \bar{r}_{i-1,t-1} \quad (3.58a)$$

$$\bar{r}_{i,t} = \bar{r}_{i-1,t-1} - K_{i-1,t}^r \bar{e}_{i-1,t}. \quad (3.58b)$$

Finally, we need to calculate  $\beta$  recursively in order:

$$\beta_{i+1,t} = \beta_{i,t} + [1 - \beta_{i,t}]^2 r_{i,t-1}' [R_{i,t-1}^r]^{-1} r_{i,t-1} \quad (3.59a)$$

$$\beta_{1,t} = 0. \quad (3.59b)$$

We can now present the Lattice Prediction Error Method (LPEM) for general model structures (3.24).

**Algorithm 3.3 (LPEM)** *The parameters of (3.24) can be estimated recursively as follows.*

1. At time instant  $t = 0$ ; initialization: for  $i = 1, \dots, n$

$$K_{i,0}^e = 0_{\alpha \times \alpha} \quad R_{i,0}^e = \delta I_{\alpha}$$

$$K_{i,0}^r = 0_{\alpha \times \alpha} \quad R_{i,0}^r = \delta I_{\alpha}$$

$$r_{i,0} = 0_{\alpha \times 1} \quad F_{i,0} = 0_{\alpha \times \alpha}$$

$n$  is the maximum order of the model, and  $\delta$  is a small number.

2. At time instant  $t$ : get  $\{y_t, u_t\}$ , compute  $\tilde{z}_t$  on the basis of  $\hat{\theta}_{n,t-1}$ , and set  $r_{0,t} = e_{0,t} := \tilde{z}_t$

3. Calculate  $e_{i,t}$  and  $r_{i,t}$  for  $i = 1, \dots, n$ , according to (3.57a) and (3.57b).
4. Calculate  $\beta_i$  according to (3.59), and update  $R_{i,t}^e$ ,  $R_{i,t}^r$ ,  $F_{i,t}$ ,  $K_{i,t}^e$  and  $K_{i,t}^r$  for  $i = 1, \dots, n$ , according to (3.49a), (3.49b), (3.52), (3.51a) and (3.51b), respectively.
5. Compute, for  $i = 1, \dots, n$ , estimates of  $\Theta_{i,t}^e$  and  $\Theta_{i,t}^r$ , according to (3.50a) and (3.50b), with  $\Theta_{0,t}^e = \Theta_{0,t}^r = \emptyset$
6. Recover the parameter estimates:  $\hat{\theta}_{i,t}$  = first column of  $\Theta_{i,t}^e$
7.  $t := t + 1$ ; goto 2

**Remark 3.5** In step 1 of Algorithm 3.3, the matrices  $R_i^e$  and  $R_i^r$  are initialized with small numbers  $\delta$ . Since they are updated as in (3.49), a small initial value has a marginal effect on the development of  $R_i^e$  and  $R_i^r$ , and the initial values of  $K_i^e$  and  $K_i^r$  are only marginally important. They will change quickly in the transient phase.

A small initial value of  $R_i^e$  and  $R_i^r$  also reflects a large uncertainty in  $K_i^e$  and  $K_i^r$  at time  $t = 0$ .

A related algorithm is obtained by approximating the gradient  $\psi$  by the regressor  $\phi$ . This Lattice Pseudo Linear Regression (LPLR) algorithm has similarity with the RPLR algorithm. The complex calculation of  $\tilde{z}_t$  from  $z_t$  in step 2 of algorithm 3.3 is replaced by

#### Algorithm 3.4 (LPLR)

2. At time instant  $t$ : get  $\{y_t, u_t\}$ , compute  $z_t$  on the basis of  $\hat{\theta}_{n,t-1}$ , and set  $r_{0,t} = e_{0,t} := z_t$

### 3.5.5 Simplified lattice algorithms for specific parametrizations

In LPEM and LPLR, the parameter estimate  $\hat{\theta}$  is recovered explicitly, to enable the calculation of  $z$  (LPLR) and  $\bar{z}$  (LPEM). However, (3.56) suggests that to compute  $\hat{y}_t(\hat{\theta}_{t-1})$ , it is not necessary to know  $\hat{\theta}_{t-1}$  explicitly. It can be computed from the reflection coefficients  $K_i^e$  and the backward residuals  $\bar{r}$ . This simplifies the LPEM algorithm for ARMAX and OE model structures. For ARX models the existing lattice algorithms (e.g., Ljung and Söderström, 1983) result.

Finally, an implementation of the Bootstrap IV method by lattice algorithms is presented.

**LELS method**

The RPLR method is obtained by approximating the gradient  $\psi$  in RPEM by the regressor  $\phi$ . For ARMAX models this results in the Recursive Extended Least Squares (RELS) method.

The same applies to their lattice counterparts. In lattice form, the LPLR algorithm 3.4 is simplified to the Lattice Extended Least Squares (LELS) method.

For ARMAX structures, the data vector  $z_t$  is defined as  $z_t = \left( -y_t \quad u_t \quad \varepsilon_t(\hat{\theta}_{t-1}) \right)'$ , where the prediction error is the difference between the measured output  $y_t$  and the predicted output  $\hat{y}_t(\hat{\theta}_{t-1})$ , which can be replaced by  $\hat{y}_t(\hat{\vartheta}_{t-1})$ . The latter can be obtained directly from the forward reflection coefficients and the backward residual errors. This results in the LELS method.

**Algorithm 3.5 (LELS)** For ARMAX model structures the parameters can be estimated recursively as follows.

1. Initialization: step 1 of LPEM (and LPLR)
2. At time instant  $t$ : get  $\{y_t, u_t\}$ , and compute  $\hat{y}_t(\hat{\vartheta}_{t-1})$  from (3.56);  
set  $z_t = \left( -y_t \quad u_t \quad y_t - \hat{y}_t \right)'$ , and set  $r_{0,t} = e_{0,t} := z_t$
- 3–5 As steps 3 to 5 of LPEM
- 6  $t := t + 1$ ; goto 2

Of course, if one needs the parameter vector  $\hat{\theta}_{i,t}$ , it can be recovered as the first column of  $\Theta_{i,t}^e$ .

**LOE method**

Another lattice identification method, which does not need explicit parameter recovery, is the Lattice Output Error (LOE) method. In this case an OE model is identified.

In OE identification, the noise-free output  $\hat{w} = \hat{y}$  is used in the regression vector. This is available from (3.56). Using this prediction for the initialization of the backward prediction error, we obtain the LOE algorithm. With respect to the LELS algorithm 3.5, only step 2 is changed:

**Algorithm 3.6 (LOE)**



2. At time instant  $t$ :

get  $\{y_t, u_t\}$ , set  $z_t = \begin{pmatrix} -y_t & u_t \end{pmatrix}'$ , compute  $\hat{y}_t$  from (3.56), and set

$$r_{0,t} := \begin{pmatrix} -\hat{y}_t & u_t \end{pmatrix}'$$

$$e_{0,t} := \begin{pmatrix} -y_t & u_t \end{pmatrix}'$$

Again it is possible to recover the model parameter  $\hat{\theta}_{i,t}$  as the first column of  $\Theta_{i,t}^e$ , if it is of interest.

### **LBIV method**

The bootstrap Instrumental Variable method can also be implemented in a lattice structure. The instruments of a bootstrap IV method are the input  $u$  and the predicted output  $\hat{y}$ . Two lattice runs are necessary at each time instant. In the first run a model is estimated, with which the process output can be predicted. In the second run this prediction is used as instrument, replacing the gradient of the lattice algorithm.

### **Algorithm 3.7 (LBIV)**

*The Lattice Bootstrap Instrumental Variable method consists of two LPLR schemes, and is given as follows.*

1. Initialization: step 1 of LPEM

2. At time instant  $t$ : get  $\{y_t, u_t\}$ , set  $z_t = \begin{pmatrix} -y_t & u_t \end{pmatrix}'$ , and set

$$r_{0,t} := z_t$$

$$e_{0,t} := z_t$$

3. Do step 3 of LELS

4. Compute  $\hat{y}_t$  according to (3.56), set  $\hat{z}_t = \begin{pmatrix} -\hat{y}_t & u_t \end{pmatrix}'$ , and set

$$r_{0,t} := \hat{z}_t$$

$$e_{0,t} := \hat{z}_t$$

5. Do step 3 of LELS

6.  $t := t + 1$ ; goto 2

### 3.5.6 Convergence of LELS

An important question is that of the convergence of lattice algorithms. For LELS, convergence is proved in this section. For the other algorithms it cannot be proven yet, just as the nonlattice algorithms. However, in all the results of our simulation experiments, they do converge.

To investigate the convergence, use is made of the following theorem, given by Ljung and Söderström (1983, theorem 4.C.1, pp. 454/455).

**Theorem 3.1 (Theorem 4.C.1 of Ljung and Söderström, 1983)**

Let  $\{\varepsilon_t\}$  and  $\{\phi_t\}$  be sequences of scalars and vectors, respectively, such that

$$\lim_{N \rightarrow \infty} \sup \frac{1}{N} \sum_{t=1}^N |\phi_t|^2 < \infty. \quad (3.60)$$

Define the sequence  $\{\hat{\theta}_t\}$  by

$$\hat{\theta}_t = \hat{\theta}_{t-1} + \frac{1}{t} R_t^{-1} \phi_t \varepsilon_t \quad (3.61)$$

$$R_t = R_{t-1} + \frac{1}{t} [\phi_t \phi_t' - R_{t-1}]. \quad (3.62)$$

Let

$$\bar{\varepsilon}_t = \varepsilon_t \left[ 1 - \frac{1}{t} \phi_t' R_t^{-1} \phi_t \right] \quad (3.63)$$

and suppose that, for some value  $\theta_0$ ,

$$H(q)\bar{\varepsilon}_t = -\phi_t' [\hat{\theta}_t - \theta_0] + H(q)\xi_t \quad (3.64)$$

where

1.  $\{\xi_t\}$  is a sequence of random variables such that

$$\mathbb{E}[\xi_t | \mathcal{F}_{t-1}] = 0 \quad (3.65a)$$

$$\mathbb{E}[\xi_t^2 | \mathcal{F}_{t-1}] = \sigma^2 \quad (3.65b)$$

and

$$\varepsilon_t - \xi_t \in \mathcal{F}_{t-1} \quad (3.66)$$

where  $\mathcal{F}_{t-1}$  is the  $\sigma$ -algebra generated by

$$\xi_0, \dots, \xi_{t-1}, \phi_0, \dots, \phi_t.$$

2.  $H(q)$  is a causal, strictly stable transfer function, such that  $1/H(q) - \frac{1}{2}$  is strictly positive real, i.e.

$$\operatorname{Re} \left[ \left[ H(e^{i\omega}) \right]^{-1} - \frac{1}{2} \right] > 0 \quad \forall \omega, \quad -\pi < \omega \leq \pi \quad (3.67)$$

Then

$$[\hat{\theta}_t - \theta_0]' R_t [\hat{\theta}_t - \theta_0] \rightarrow 0 \quad \text{w.p.1 as } t \rightarrow \infty \quad (3.68)$$

and

$$\frac{1}{N} \sum_{t=1}^N [\bar{\varepsilon}_t - \xi_t]^2 \rightarrow 0 \quad \text{w.p.1 as } N \rightarrow \infty. \quad (3.69)$$

The proof of theorem 3.1 is given by Ljung and Söderström (1983).

Theorem 3.1 will be used to prove the convergence of the LELS estimate  $\hat{\vartheta}_t$ , stated in the following theorem:

**Theorem 3.2** Consider algorithm 3.5. The estimated parameter vector  $\hat{\vartheta}_{i,t}$  is given by (3.55), and the regression vector  $\varphi_{i,t}$  is given by (3.54). Let the covariance matrix  $R_{i,t}$  be defined as

$$R_{i,t} = \sum_{k=1}^t \lambda^{t-k} \varphi_{i,t} \varphi_{i,t}' \quad (3.70)$$

Suppose that the process can be described by an ARMAX model as

$$A_0(q)y_t = B_0(q)u_t + C_0(q)\xi_t \quad (3.71)$$

with  $\xi_i$  a ZMWN sequence, and suppose that  $1/C_0(q) - \frac{1}{2}$  is strictly positive real. Let  $\vartheta_0$  contain the parameters of the polynomials  $A_0$ ,  $B_0$  and  $C_0$ , transformed via an orthogonal basis transformation of the regressor space. Then the estimated parameter vector  $\hat{\vartheta}_{i,t}$  satisfies

$$[\hat{\vartheta}_{i,t} - \vartheta_0]' R_{i,t} [\hat{\vartheta}_{i,t} - \vartheta_0] \rightarrow 0 \quad \text{w.p.1 as } t \rightarrow \infty \quad \forall i \in \{1, 2, \dots, n\} \quad (3.72)$$

and

$$\frac{1}{N} \sum_{t=1}^N [\bar{\varepsilon}_{i,t} - \xi_i]^2 \rightarrow 0 \quad \text{w.p.1 as } N \rightarrow \infty \quad \forall i \in \{1, 2, \dots, n\}. \quad (3.73)$$

**Proof** It will be proven by analogy with Theorem 3.1 that the forward reflection coefficient matrix  $K_{i,t}^e$  converges asymptotically for all  $i$ . It follows then immediately that the whole parameter vector  $\vartheta_i$  in (3.55) converges asymptotically.

The forward reflection coefficient matrix is defined by (3.51a), and can be written in its transposed form as

$$K_{i,t}^{e'} = [R_{i,t-1}^r]^{-1} F_{i,t} \quad i = 1, 2, \dots, n \quad (3.74)$$

where  $R_{i,t}^r$  and  $F_{i,t}$  are defined by (3.49b) and (3.52), respectively.

Hence  $K_{i,t}^{e'}$  can be seen as the Least Squares solution of an estimation problem for the following model:

$$e_{i,t} = K_{i,t-1}^e r_{i,t-1} \quad i = 1, 2, \dots, n \quad (3.75)$$

with associated prediction error  $\varepsilon_{i,t}$ :

$$\varepsilon_{i,t} = [e_{i,t}' - r_{i,t-1}' K_{i,t-1}^{e'}] \eta \quad i = 1, 2, \dots, n. \quad (3.76)$$

From (3.49b) the following relation is obtained by a time shift:

$$R_{i,t-1}^r = \lambda R_{i,t-2}^r + \bar{r}_{i,t-1} r_{i,t-1} \quad i = 1, 2, \dots, n. \quad (3.77)$$

To show more explicitly the analogy with (3.62), we recall (3.54) and define

$$\varphi_t = \bar{r}_{i,t-1} \quad (3.78)$$

Now defining  $\bar{R}_t$  as

$$\bar{R}_t = \frac{1}{t} \sum_{k=1}^t \varphi_k \varphi_k' \quad (3.79)$$

it follows that  $\bar{R}_t \equiv \frac{1}{t} [R_{i,t-1}^r]^{-1}$ . Thus (3.77) can be rewritten as

$$\bar{R}_t = \lambda \bar{R}_{t-1} + \frac{1}{t} \left[ \frac{\varphi_t \varphi_t'}{1 - \beta_{i,t}} - \bar{R}_{t-1} \right]. \quad (3.80)$$

The forgetting factor  $\lambda$  ( $0 < \lambda \leq 1$ ) and the coefficient  $(1 - \beta_{i,t})$  ( $0 \leq \beta_{i,t} < 1$ ) do not influence the proof of Theorem 3.1, and therefore (3.80) is similar to (3.62).

Making use of the Matrix Inversion Lemma (A.13), we obtain from (3.77):

$$[R_{i,t-1}^r]^{-1} = \frac{1}{\lambda} [R_{i,t-2}^r]^{-1} - \frac{1}{\lambda} \frac{[R_{i,t-2}^r]^{-1} \bar{r}_{i,t-1} r'_{i,t-1} [R_{i,t-2}^r]^{-1}}{\lambda + r'_{i,t-1} [R_{i,t-2}^r]^{-1} \bar{r}_{i,t-1}}. \quad (3.81)$$

Since

$$\frac{[R_{i,t-2}^r]^{-1} \bar{r}_{i,t-1}}{\lambda + r'_{i,t-1} [R_{i,t-2}^r]^{-1} \bar{r}_{i,t-1}} = [R_{i,t-1}^r]^{-1} \bar{r}_{i,t-1} \quad (3.82)$$

a recursive equation for the parameter  $K_{i,t}^{e'} \eta$  is obtained:

$$K_{i,t}^{e'} \eta = K_{i,t-1}^{e'} \eta + [R_{i,t-1}^r]^{-1} \bar{r}_{i,t-1} \varepsilon_{i,t} \quad i = 1, 2, \dots, n. \quad (3.83)$$

Choosing  $\hat{v}_t = K_{i,t}^{e'} \eta$ , this can be rewritten as

$$\hat{v}_t = \hat{v}_{t-1} + \frac{1}{t} \bar{R}_t^{-1} \varphi_t \varepsilon_t \quad (3.84)$$

which is in analogy with (3.61).

To complete the analogy of theorem 3.1, we need two more relations, concerning the residual error  $\bar{\varepsilon}$ :

$$\bar{\varepsilon}_{i,t} = (1 - \beta_{i,t}) \varepsilon_{i,t} = \left( 1 - \frac{1}{t} \varphi_t' \bar{R}_t^{-1} \varphi_t \right) \varepsilon_{i,t} \quad i = 1, 2, \dots, n \quad (3.85)$$

which is the same as (3.63).

As a final step, we derive a relationship which is analogous to (3.64). Because of (3.71), a parameter vector  $\vartheta_0$  exists, such that

$$y_t = \vartheta_0' \varphi_{0,t} + \xi_t \quad (3.86)$$

in which  $\varphi_{0,t}$  is defined as

$$\varphi_{0,t} = ( -y_{t-1} \quad u_{t-1} \quad \xi_{t-1} \quad \cdots \quad -y_{t-n} \quad u_{t-n} \quad \xi_{t-n} )'. \quad (3.87)$$

Note that  $\varphi_{0,t}$  contains the noise terms  $\xi$  instead of the prediction errors  $\varepsilon$ . The residual error is then defined as

$$\begin{aligned} \bar{\varepsilon}_t &= y_t - \hat{\vartheta}_t' \varphi_t \\ &= \vartheta_0' \varphi_{0,t} - \hat{\vartheta}_t' \varphi_t + \xi_t \\ &= \vartheta_0' (\varphi_{0,t} - \varphi_t) + (\vartheta_0 - \hat{\vartheta}_t)' \varphi_t + \xi_t \\ &= [C_0(q) - 1] [\xi_t - \bar{\varepsilon}_t] + (\vartheta_0 - \hat{\vartheta}_t)' \varphi_t + \xi_t. \end{aligned} \quad (3.88)$$

This can be rewritten as

$$C_0(q)\bar{\varepsilon}_t = -\varphi_t' (\hat{\vartheta}_t - \vartheta_0) + C_0(q)\xi_t \quad (3.89)$$

which is clearly analogous to (3.64).

Since  $\{\xi_t\}$  is a ZMWN sequence, it satisfies (3.65)–(3.66).

Because of the similarities between the relationships derived above, and the equations in theorem 3.1, the theorem holds for  $K_{i,t}^{e'}$ ,  $\bar{r}_{i,t-1}$  and  $\bar{\varepsilon}_{i,t}$ . It then follows that  $K_{i,t}^{e'}$  converges asymptotically as (3.68), for all  $i \in \{1, 2, \dots, n\}$ .

Since the covariance matrix  $R_{i,t}$  is diagonal, convergence of  $K_{i,t}^{e'}$  does not influence convergence of  $K_{j,t}^{e'}$  ( $i \neq j$ ). This means that all subvectors of the parameter vector  $\hat{\vartheta}_{i,t}$  converge. It then follows that  $\hat{\vartheta}_{i,t}$  converges according to (3.72), which completes the proof.  $\blacksquare$

From the theorem, it follows that the LELS algorithm 3.5 is a recursive parameter estimation scheme, of which the parameters converge asymptotically if the process is in the model set (ARMAX) and the polynomial  $C_0(q)$  satisfies (3.67). No guarantees can be given if the process is not in the model set. This is also the case for other recursive estimation schemes, such as RELS. In fact, this is the case for all Prediction Error identification methods, which justifies the interest in approximate identification.

### 3.5.7 Simulation results

To analyze the behavior of the proposed lattice algorithms, they are compared with the direct implementations of RPEM in the Matlab System Identification Toolbox (Ljung, 1993). First we investigate the computational properties, then some simulation examples show the behavior with noisy data.

The computational properties of the algorithms can be measured in terms of the calculation time and memory size required. The calculation time is proportional to the number of *flops* (MATLAB's floating point operations) it takes to estimate a model. For lattice algorithms, it depends linearly on the model order  $n$ , and for nonlattice algorithms it depends quadratically on the model order.

To illustrate this, a comparison is made between RPEM, RELS, LPEM and LELS. AR-MAX models of different orders are estimated, and the number of flops is plotted in Figure 3.2, which clearly shows the dependence on  $n$ . It also shows that, for model orders higher than 2, the lattice algorithms are faster.

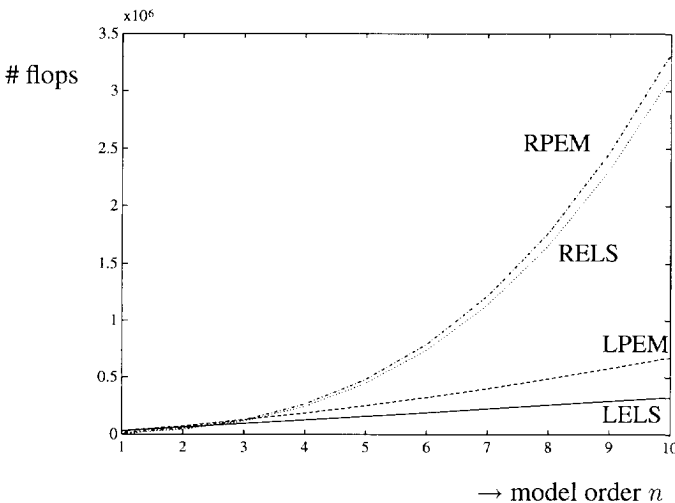

Figure 3.2. Total number of flops versus the model order for LELS (solid), LPEM (dashed), RELS (dotted) and RPEM (dash-dotted)

The LELS and RELS algorithms are obtained from LPEM and RPEM, respectively, by replacing the gradient by the regression vector. This reduces the number of computations, as reflected in Figure 3.2.

The computation time is partly traded off against the memory space that the algorithms need. For ARMAX models RPEM requires  $(9n^2 + 15n)/2$  values to be stored, and LPEM needs  $49n$  memory locations. Hence RPEM needs less memory space for model orders smaller than 9. For higher order ARMAX models, LPEM requires less memory.

To investigate the numerical behavior of the lattice algorithms, we apply LPEM and RPEM to an arbitrary system

$$(1 - 1.5q^{-1} + 0.7q^{-2})y_t = \frac{q^{-1} + 0.5q^{-2}}{1 - 0.5q^{-1} + 0.1525q^{-2}}u_t + \frac{1 - q^{-1} + 0.2q^{-2}}{1 - q^{-1} + 0.5q^{-2}}e_t \quad (3.90)$$

with  $u_t$  a PRBS signal and  $e_t$  Zero Mean White Noise (ZMWN). The signal-to-noise ratio of the experiment is 40 dB.

In Figure 3.3, the estimated parameters of a second order model are shown. Figure 3.3a gives the results of the LPEM algorithm, and figure 3.3b gives the results of the RPEM algorithm. It is clear that the RPEM method does not converge, whereas the LPEM method gives a satisfactory result. Hence, LPEM shows better convergence than RPEM.

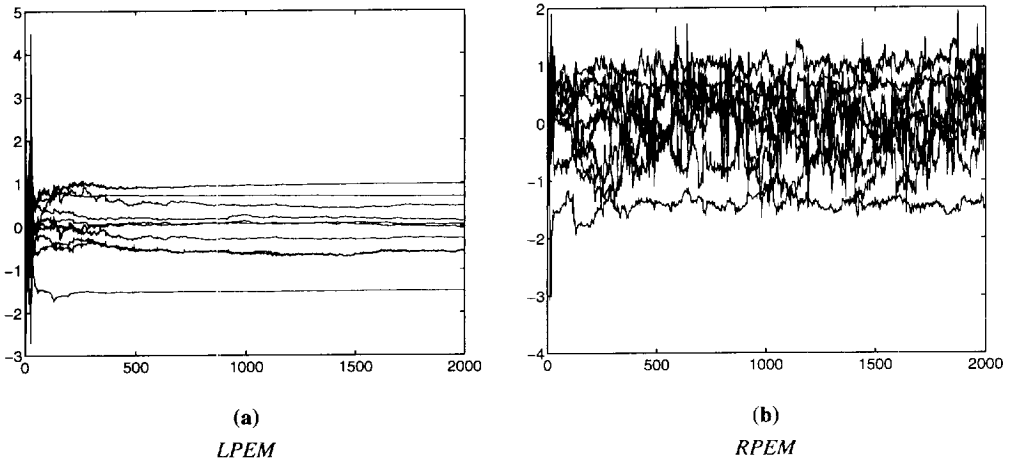

Figure 3.3. Recursive parameter estimates of second order models

The LOE method is illustrated with the following system.

$$y_t = \frac{q^{-1} + 0.5q^{-2}}{1 - 1.5q^{-1} + 0.7q^{-2}}u_t + e_t$$



with  $u_t$  a PRBS signal and  $e_t$  again ZMWN. The signal-to-noise ratio of the experiment is 10 dB.

In figure 3.4, the parameter estimates for LOE (a) and ROE (b) are shown for second order models. It appears that for both algorithms, the bias tends to zero. The variance of the

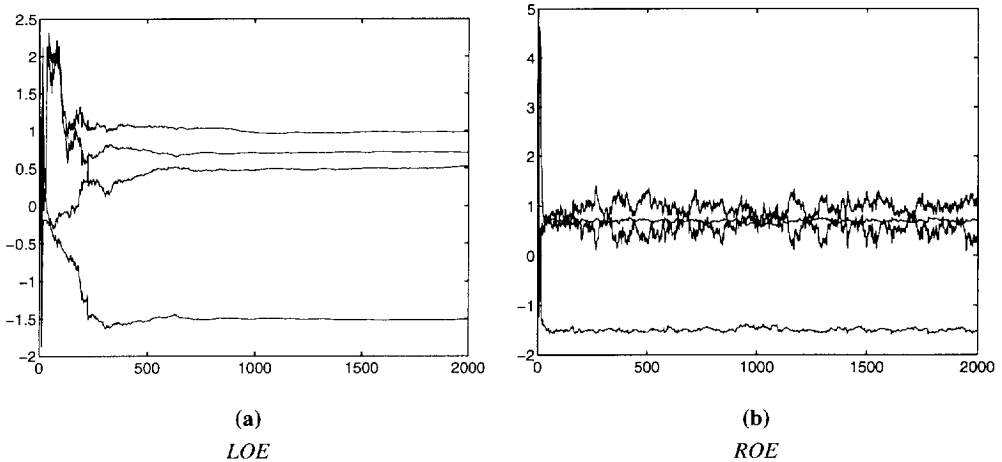

Figure 3.4. Recursive parameter estimates for second order models

ROE estimate, however, is quite large, and does not die out.

Considering the parameter estimates for the first 300 samples, it can be seen that ROE changes more quickly than LOE. This indicates a larger adaptation gain or a smaller forgetting factor  $\lambda$  for ROE, and could at the same time explain the higher variance of the ROE estimate.

However, both algorithms have  $\lambda = 0.95$ , so the difference in speed of change of the algorithms must have a different cause. This is still under investigation.

### 3.5.8 On-line closed-loop identification

In this section we discuss how the lattice algorithms, derived in the previous sections, can in principle be used for on-line closed-loop identification. The actual implementation is not considered, and remains an issue for further research.

Since the proposed lattice algorithms are SISO, we only consider SISO closed-loop systems.

The Generalized closed-loop identification method involves one input  $r$  and two outputs,  $y$  and  $u$ . Therefore, even in the SISO case, it cannot be implemented in the currently

available lattice algorithms. An extension toward MIMO is necessary.

The Two-Step method, however, can be implemented by using a lattice algorithm for each step. This is illustrated in Figure 3.5, where two LOE algorithm are placed in series.

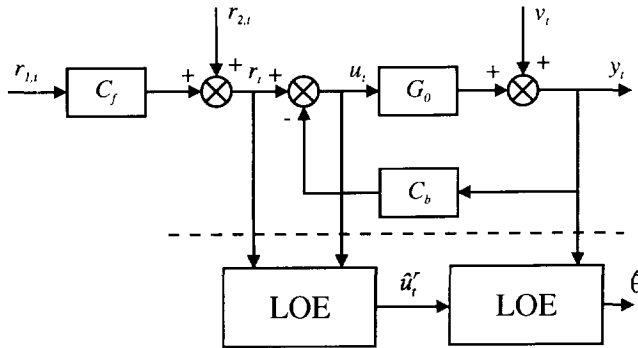

Figure 3.5. Two-Step closed-loop identification with two lattice algorithms

parameters of  $\hat{S}$  do not have to be calculated explicitly, because  $u_i^r$  is directly available from the first lattice algorithm.

DI can be implemented as well, and so can IV. JIO needs a multivariable algorithm, which is not available. Finally, II can be implemented, but the on-line computation of  $\hat{G}$  will be difficult.

### 3.6 Conclusions

In this chapter we have discussed some parametrization aspects of identification. A procedure for dead-time estimation has been discussed, and the ORThogonal FIR parametrization has been described as a useful parametrization, which is linear in the parameters.

A model structure selection procedure has been proposed with which a suitable pseudo-canonical parametrization can be obtained. The procedure consists of two steps. In the first step high order MISO OE models are estimated, with which noise-free outputs are calculated. In the second step, these noise-free outputs are used to evaluate all possible parametrizations up to a given order. A model structure can be selected from this evaluation.

For SISO systems, lattice algorithms have been derived for more general model structures than AR and ARX. These algorithms provide models of different order simultaneously, and they appear to have good numerical behavior in the simulations.

Convergence of LELS has been proved. This proof cannot be given for LPEM and other lattice algorithms.

Lattice implementation of TS, DI and IV for closed-loop identification is possible in principle, but has not yet been done. For GI and JIO, multivariable lattice algorithms have to be developed first.



## Chapter 4

---

# ***Control-relevant identification***

## ***4.1 Introduction***

The two previous chapters have dealt with black-box identification. Procedures have been discussed with which it is possible to obtain a model from (closed-loop) data. In these procedures the intended model application, which is assumed to be the (re)design of a controller, is not taken into account explicitly. In other words, the identification is not *control-relevant*, and it is not clear in what sense a model should be improved, to result in a controller with higher performance. The model errors are accepted in the controller design step as given facts, and are incorporated in the designed controller, as is done in, e.g., *robust control* (Morari and Zafiriou, 1989).

Recently, it has been argued that the control strategy should be taken into consideration in the identification step. The model, and the model error, can then be shaped in such a way that the resulting controller achieves a higher performance (Schrama, 1992b; Gevers, 1993; Van den Hof and Schrama, 1994).

For instance, consider a desired increase of closed-loop stability margins, which requires an accurate model around the closed-loop bandwidth. If the closed-loop bandwidth is known in advance, the identification procedure should be adapted to incorporate this requirement by redistributing the model error over the frequency range. Since the controller, and therefore the closed-loop bandwidth, are generally not known in advance, this naturally leads to an iterative scheme of identification and controller design (Schrama, 1992b).

Thus, unlike the classical approach, the identification procedure should take into account control design specifications. In this chapter, we pursue this concept of control-relevant identification.

The trend toward the joint design of identification and control (Gevers, 1993) has resulted in the development of several different iterative schemes of identification and control

design, where the difference stems from the specific control strategy used. These schemes are discussed in Section 4.2. One particular scheme for identification and Linear Quadratic (LQ) control design, the *Zang scheme* (Zang *et al.*, 1992), is discussed in more detail in Section 4.3.

The existing iterative schemes make extensive use of identification experiments. Although the number of experiments can, in general, be large in mechanical applications, in the process industry experiments are expensive, and their number should be kept to a minimum. Therefore, the closed-loop performance enhancement should be realized with the minimum number of experiments required. This can be accomplished by optimizing the identification experiment, which is discussed in Chapter 5, and by carefully designing identification filters based on control-design specifications. This requires an additional iterative loop, in which the designed controller is used to redesign the identification filters. In Section 4.4 it is discussed how these filters should be chosen in the Zang scheme. Applying the additional loop to the other iterative schemes of identification and controller design results in an extended scheme, presented in Section 4.5.

Possible stop criteria for the iteration loops are proposed in Section 4.6, and some conclusions are drawn in Section 4.7.

## 4.2 Iterative identification and controller design

A general control design aim is to maximize the performance of a controlled plant. To this end, performance is defined in terms of a cost function or cost criterion.

The total cost criterion is, in general, a scalar function of properties of the controlled process. These properties are denoted by  $J(G_0, C)$ , thus reflecting the dependence on the plant  $G_0$  and the controller  $C$ , and can be defined in terms of transfer function matrices or signals. A typical cost criterion is the norm (any norm)  $\|J(G_0, C)\|$ , which is sometimes denoted as the *achieved performance cost*. The optimal controller  $C^*$  is the controller that minimizes  $\|J(G_0, C)\|$ :

$$C^* = \arg \min_C \|J(G_0, C)\|. \quad (4.1)$$

This optimization problem cannot be solved in practice. Simulation cannot be used, since the plant  $G_0$  is unknown, and optimization by trial and error is not allowed because experiments are (too) expensive.

If  $G_0$  in (4.1) is replaced by a model  $\hat{G}$ , (4.1) is solvable. However, the designed controller minimizes  $\|J(\hat{G}, C)\|$ , and the difference between  $\|J(G_0, C)\|$  and  $\|J(\hat{G}, C)\|$  depends on the quality of the model  $\hat{G}$ . This is expressed by the upper bound on  $\|J(G_0, C)\|$ , which

can be derived from the triangle inequality of norms (Appendix A) (Schrama, 1992a/b):

$$\|J(G_0, C)\| \leq \|J(\hat{G}, C)\| + \|J(G_0, C) - J(\hat{G}, C)\| \quad (4.2)$$

where  $\|J(G_0, C) - J(\hat{G}, C)\|$  is sometimes called the *performance degradation*. Instead of solving (4.1), the upper bound in (4.2) is minimized over  $\hat{G}$  and  $C$ . Hence (4.1) is replaced by

$$(\hat{G}, C^*) = \arg \min_{\hat{G}, C} \{\|J(\hat{G}, C)\| + \|J(G_0, C) - J(\hat{G}, C)\|\}. \quad (4.3)$$

Again (4.3) cannot be solved in practice, because the influence of  $C$  on  $J(G_0, C)$  is unknown without additional experiments. Therefore (4.3) is split into two parts:

1. An *identification* part (ID), in which  $\|J(G_0, C) - J(G, C)\|$  is minimized over  $G$ , while keeping  $C$  constant,
2. A *controller design* part (CD), in which  $\|J(\hat{G}, C)\|$  is minimized over  $C$ , while keeping  $\hat{G}$  constant.

These two steps are performed iteratively. Introducing  $i$  to denote the iteration, the model  $\hat{G}_i$  is obtained from data with the previous controller  $C_{i-1}$  implemented, and the controller  $C_i$  is designed on the basis of  $\hat{G}_i$ . Steps 1 and 2 can then be written as

$$\text{ID : } \hat{G}_i = \arg \min_G \|J(G_0, C_{i-1}) - J(G, C_{i-1})\| \quad (4.4a)$$

$$\text{CD : } C_i = \arg \min_C \|J(\hat{G}_i, C)\| \quad (4.4b)$$

To solve (4.3), (4.4a) and (4.4b) are performed iteratively. Each designed controller  $C_i$  is implemented, and new data is acquired to solve (4.4a) and, subsequently, (4.4b).

The minimizations in (4.4) are the very basis of iterative identification and control design schemes.

Convergence of this iterative scheme to a specific controller  $C$  cannot be guaranteed, since, instead of solving the original optimization problem (4.3), two different optimization problems (4.4) are solved. However, improvement in control performance can be monitored, and the iterations can be stopped if no improvement is achieved.

As an example of this iterative scheme, consider the LQ control cost criterion for which  $J(G_0, C) = \left( (r_t - y_t)' \quad \lambda u_t' \right)'$  (note that the minimizing argument of a norm is the same as the minimizing argument of its square):

$$\begin{aligned}
 \|J_C(G_0, C)\| &= \left\| \begin{array}{c} r_t - y_t \\ \lambda u_t \end{array} \right\|_2 \\
 &= \left\| \begin{array}{c} r_t - \hat{y}_t \\ \lambda \hat{u}_t \end{array} \right\| + \left\| \begin{array}{c} \hat{y}_t - y_t + r_t - r_t \\ \lambda u_t - \lambda \hat{u}_t \end{array} \right\|_2 \\
 &\leq \left\| \begin{array}{c} r_t - y_t \\ \lambda u_t \end{array} \right\| - \left\| \begin{array}{c} r_t - \hat{y}_t \\ \lambda \hat{u}_t \end{array} \right\|_2 + \left\| \begin{array}{c} r_t - \hat{y}_t \\ \lambda \hat{u}_t \end{array} \right\|_2 \\
 &= \underbrace{\left\| \begin{array}{c} r_t - \hat{y}_t \\ \lambda \hat{u}_t \end{array} \right\|_2}_{\text{CD}} + \underbrace{\left\| \begin{array}{c} y_t - \hat{y}_t \\ \lambda(u_t - \hat{u}_t) \end{array} \right\|_2}_{\text{ID}}.
 \end{aligned} \tag{4.5}$$

The upper bound (4.3) is decreased by iteratively minimizing the ID and the CD part, as in (4.4).

Four major iterative identification and control design schemes can be distinguished in literature.

- The Zang scheme (Zang *et al.*, 1991; Bitmead and Zang, 1991; Bitmead, 1993; Partanen and Bitmead, 1993; Partanen *et al.*, 1994) integrates Direct Identification and LQ control design. In Section 4.3 this approach is analyzed more thoroughly. In Section 4.4 an improvement of the identification part is proposed. Analogous schemes are proposed by Bitmead *et al.* (1990) and by Shook *et al.* (1992) for Generalized Predictive Control (Clarke *et al.*, 1987a/b).
- The *windsurfer* approach to adaptive robust control (Anderson and Kosut, 1991; Lee *et al.*, 1992, 1993a/b, 1994) integrates Internal Model Control design and the Hansen closed-loop identification scheme (Hansen *et al.*, 1989). This closed-loop identification scheme is based on the use of fractional representations, and the dual Youla parametrization, by which all systems that are stabilized by a given controller, are parametrized.
- Another robust control-oriented procedure is  $H_\infty$ -design based on robustness optimization, proposed by Schrama (1992a/b). This procedure is based on the dual Youla parametrization as well, and uses coprime factor identification of the plant (Van den Hof *et al.*, 1993; De Callafon *et al.*, 1993, 1994).
- The matching of pole-placement control design and closed-loop identification is considered by Åström (1993), and analyzed in more detail by Åström and Nilsson (1994).



The schemes have in common that they combine identification and controller design, where the process is re-identified, and the controller is redesigned in each step. For a more extensive treatment of these iterative schemes, we refer the reader to Van den Hof and Schrama (1994).

**Remark 4.1** A related approach is developed by Zhu (1990), who proposes to design a sequence of controllers, and implement these in cascade. Each controller is designed to control the closed-loop system that consists of the process and all previously designed controllers.

Although this approach is iterative, it does not combine identification and controller design in the sense of the four schemes previously mentioned, because the system that is identified changes in every iteration step.

### 4.3 The Zang scheme for LQ control design

The Zang scheme (Zang *et al.*, 1991) was developed to integrate closed-loop identification and Linear Quadratic (LQ) or predictive control. Filters are used in the controller design procedure to incorporate the model mismatch. Direct Identification is used to obtain a model from closed-loop data.

In this section, Zang's LQ controller design procedure is discussed. It is assumed that  $N \rightarrow \infty$ , and hence  $\frac{1}{N} \sum_{t=1}^N$  is replaced by the generalized expectation operator  $\bar{\mathbb{E}}$ . We restrict attention to SISO systems.

The control cost criterion for controller  $C_i$  is defined as the square of a two-norm:

$$\|J^{\text{glob}}(G_0, C)\|_2^2 = \bar{\mathbb{E}} \{ [r_t - y_t(G_0, C)]^2 + \lambda^2 u_t^2(G_0, C) \} \quad (4.6a)$$

$$= \frac{1}{2\pi} \int_{-\pi}^{\pi} [\Phi_{r-y}(G_0, C) + \lambda^2 \Phi_u(G_0, C)] d\omega \quad (4.6b)$$

$$= \left\| \begin{bmatrix} \Phi_{r-y}^{1/2}(G_0, C) & \lambda \Phi_u^{1/2}(G_0, C) \end{bmatrix} \right\|_2^2 \quad (4.6c)$$

where  $\Phi^{1/2}(e^{i\omega})$  is the stable, minimum-phase spectral factor of  $\Phi(\omega)$ , and the superscript *glob* indicates that the criterion is global.

The optimal controller  $C^*$  is

$$C^* = \arg \min_C \|J^{\text{glob}}(G_0, C)\|_2^2. \quad (4.7)$$

Since the true process  $G_0$  is unknown, a controller  $C_i$  is designed by minimizing the designed performance cost criterion

$$\|J_i^{\text{glob}}(\hat{G}_i, C)\|_2^2 = \mathbb{E} \left\{ [r_t - \hat{y}_t(\hat{G}_i, C)]^2 + \lambda^2 \hat{u}_t^2(\hat{G}_i, C) \right\} \quad (4.8)$$

with  $\hat{G}_i$  the  $i$ th model of  $G_0$ .

However, this implies the use of the certainty equivalence principle: to design the controller, it is assumed that the process equals the model. The model errors are neglected, and to incorporate them in the control design criterion, the local performance criterion  $\|J_i^{\text{loc}}\|_2^2$  is introduced, with control-design filters  $F_y$  and  $F_u$ .

$$\|J_i^{\text{loc}}(\hat{G}_i, C)\|_2^2 = \mathbb{E} \left\{ [F_{y,i}(r_t - \hat{y}_t(\hat{G}_i, C))]^2 + \lambda^2 [F_{u,i}\hat{u}_t(\hat{G}_i, C)]^2 \right\} \quad (4.9a)$$

$$= \frac{1}{2\pi} \int_{-\pi}^{\pi} [ |F_{y,i}|^2 \Phi_{r-\hat{y}}(\hat{G}_i, C) + \lambda^2 |F_{u,i}|^2 \Phi_{\hat{u}}(\hat{G}_i, C) ] d\omega \quad (4.9b)$$

$$= \left\| \begin{bmatrix} F_{y,i} \Phi_{r-\hat{y}}^{1/2}(\hat{G}_i, C) & F_{u,i} \Phi_{\hat{u}}^{1/2}(\hat{G}_i, C) \end{bmatrix} \right\|_2^2. \quad (4.9c)$$

The controller  $C_i$  is obtained as

$$C_i = \arg \min_C \|J_i^{\text{loc}}(\hat{G}_i, C)\|_2^2. \quad (4.10)$$

The criterion is local, since the global objective remains minimizing (4.8). The filters  $F_y$  and  $F_u$  are used to bring the local criterion closer to the global criterion, such that the controller  $C_i$  is closer to  $C^*$  in (4.7).

Comparing (4.6b) and (4.9b) it can be seen that, to match the global and the local control objectives, the filters should be chosen such that

$$|F_{y,i}|^2 = \frac{\Phi_{r-y}(G_0, C_i)}{\Phi_{r-\hat{y}}(\hat{G}_i, C_i)} \quad |F_{u,i}|^2 = \frac{\Phi_u(G_0, C_i)}{\Phi_{\hat{u}}(\hat{G}_i, C_i)}. \quad (4.11)$$

However, since the quantities  $\Phi_{r-y}(G_0, C_i)$  and  $\Phi_u(G_0, C_i)$  are not known, and neither can be measured before implementing the new controller  $C_i$ , the filters have to be approximated. A reasonable approximation is (Zang *et al.*, 1991)

$$|F_{y,i}|^2 = \frac{\Phi_{r-y}(G_0, C_{i-1})}{\Phi_{r-\hat{y}}(\hat{G}_i, C_{i-1})} \quad |F_{u,i}|^2 = \frac{\Phi_u(G_0, C_{i-1})}{\Phi_{\hat{u}}(\hat{G}_i, C_{i-1})}. \quad (4.12)$$

Hence, the control design procedure is adapted to incorporate the model mismatch, by introducing local filters  $F_{y,i}$  and  $F_{u,i}$  (4.12).

In the Zang scheme, Direct Identification is used to obtain each model  $\hat{G}_i$ . Although the bias distribution then depends on the noise contribution, it is assumed that a noise model of a sufficiently high order is estimated, and that the excitation is sufficiently large to dominate the noise in the frequency region of importance. These assumptions are hard to satisfy, and the bias distribution will therefore depend on the noise, as shown in Chapter 2.

## 4.4 Improved identification in the Zang scheme

If the Generalized Identification method (Section 2.5) is used in the Zang scheme, instead of Direct Identification, the bias distribution does not depend on the noise, and it is tunable through the identification filters  $L_y$  and  $L_u$ .

If these filters are based on the future controller, they can tune the bias distribution such that it is, in some sense, optimal for the future controller (e.g., small error near the closed-loop bandwidth). A better controller is thus obtained with the same data set, and hence fewer experiments are required to improve the closed-loop performance. This approach is presented in this section.

The triangle inequality for the global control performance cost criterion (4.6a) gives

$$\|J^{\text{glob}}(G_0, C_i)\|_2 \leq \|J^{\text{loc}}(\hat{G}_i, C_i)\|_2 + \|J^{\text{glob}}(G_0, C_i) - J^{\text{loc}}(\hat{G}_i, C_i)\|_2. \quad (4.13)$$

The Zang scheme concentrates on finding filters  $F_y$  and  $F_u$  (4.12) such that the local properties  $J^{\text{loc}}(\hat{G}_i, C_i)$  tend to the global properties  $J^{\text{glob}}(G_0, C_i)$ . The identification is done with Direct Identification, assuming that the excitation signal dominates the noise in the frequency range of interest.

As discussed in Section 4.2, a model should be obtained by solving (4.4a). From (4.13) and (4.5) we see that in the LQ case this becomes

$$\hat{G}_i = \arg \min_G \left\| \begin{matrix} y_t(C_i) - \hat{y}_t(G, C_i) \\ \lambda(u_t(C_i) - \hat{u}_t(G, C_i)) \end{matrix} \right\|_2^2 \quad (4.14)$$

where the criterion has been written in a general quadratic form.

Comparing (4.14) with (2.86), we see that the criterion function that is minimized in (4.14) is the GI criterion  $V_{\text{GI},\infty}$ , with  $L_y = L_u = 1$ . Hence the global identification criterion

$V_\infty^{\text{glob}}$  that should be minimized in the Zang scheme is

$$V_\infty^{\text{glob}}(G, G_0, C_i) = \bar{\mathbb{E}} \left\{ [y_t(G_0, C_i) - \hat{y}_t(G, C_i)]^2 + \lambda^2 [u_t(G_0, C_i) - \hat{u}_t(G, C_i)]^2 \right\} \quad (4.15a)$$

$$= \frac{1}{2\pi} \int_{-\pi}^{\pi} [\Phi_{y-\hat{y}}(G_0, G, C_i) + \lambda^2 \Phi_{u-\hat{u}}(G_0, G, C_i)] d\omega \quad (4.15b)$$

$$= \left\| \Phi_{y-\hat{y}}^{1/2}(G_0, G, C_i) \quad \lambda \Phi_{u-\hat{u}}^{1/2}(G_0, G, C_i) \right\|_2^2. \quad (4.15c)$$

The dependence of  $V_\infty^{\text{glob}}$  on  $C_i$  again indicates the need for an iterative procedure. However, this requires each  $C_i$  to be implemented, and a new experiment must be carried out for each new controller.

Since in the process industry experiments are expensive, the number of experiments must be kept small. This can be accomplished by defining a local identification criterion  $V_\infty^{\text{loc}}(G, G_0, C_{i-1})$ , calculated from the data that is obtained while  $C_{i-1}$  is implemented that is close to  $V_\infty^{\text{glob}}(G, G_0, C_i)$ . The identification filters  $L_y$  and  $L_u$  of GI can be used to match  $V_\infty^{\text{loc}}$  and  $V_\infty^{\text{glob}}$ , thereby imitating the effect of implementing  $C_i$ .

In the remaining part of this section we discuss how  $L_y$  and  $L_u$  can be designed.

The local identification criterion  $V_\infty^{\text{loc}}$  is given by

$$V_\infty^{\text{loc}}(G_0, G, C_{i-1}) = \bar{\mathbb{E}} \left\{ [L_y(y_t(G_0, C_{i-1}) - \hat{y}_t(G, C_{i-1}))]^2 + \lambda^2 [L_u(u_t(G_0, C_{i-1}) - \hat{u}_t(G, C_{i-1}))]^2 \right\} \quad (4.16a)$$

$$= \frac{1}{2\pi} \int_{-\pi}^{\pi} [|L_y|^2 \Phi_{y-\hat{y}}(G_0, G, C_{i-1}) + \lambda^2 |L_u|^2 \Phi_{u-\hat{u}}(G_0, G, C_{i-1})] d\omega \quad (4.16b)$$

$$= \left\| L_y \Phi_{y-\hat{y}}^{1/2}(G_0, G, C_{i-1}) \quad \lambda L_u \Phi_{u-\hat{u}}^{1/2}(G_0, G, C_{i-1}) \right\|_2^2. \quad (4.16c)$$

Comparing (4.15) and (4.16), we see that the filters should be chosen such that

$$|L_{y,i}|^2 = \frac{\Phi_{y-\hat{y}}(G_0, \hat{G}_i, C_i)}{\Phi_{y-\hat{y}}(G_0, \hat{G}_i, C_{i-1})} \quad |L_{u,i}|^2 = \frac{\Phi_{u-\hat{u}}(G_0, \hat{G}_i, C_i)}{\Phi_{u-\hat{u}}(G_0, \hat{G}_i, C_{i-1})}. \quad (4.17)$$

Note that these expressions are quite similar to (4.12) for the local control-design filters.

With the expression (2.42) for  $y$  and  $u$ , (4.17) can be calculated as

$$|L_{y,i}|^2 = \frac{|G_0 S_{0,i} - \hat{G}_i \hat{S}_{i,i}|^2 \Phi_r + |S_{0,i}|^2 \Phi_v}{|G_0 S_{0,i-1} - \hat{G}_i \hat{S}_{i,i-1}|^2 \Phi_r + |S_{0,i-1}|^2 \Phi_v} \quad (4.18a)$$

$$|L_{u,i}|^2 = \frac{|S_{0,i} - \hat{S}_{i,i}|^2 \Phi_r + |C_{b,i} S_{0,i}|^2 \Phi_v}{|S_{0,i-1} - \hat{S}_{i,i-1}|^2 \Phi_r + |C_{b,i-1} S_{0,i-1}|^2 \Phi_v} \quad (4.18b)$$

where the first index on the estimates  $\hat{S}_{i,i}$  indicates the iteration step (always  $i$ ), and the second index indicates which controller was implemented. Thus,  $\hat{S}_{i,i-1}$  is an estimate of  $S_{0,i-1}$  in iteration step  $i$ , estimated from data that was obtained while  $C_{i-1}$  was implemented, and

$$S_{0,i-1} = \frac{1}{1 + C_{b,i-1}G_0}. \quad (4.19)$$

Of course, the filters cannot be calculated as in (4.18), because the noise spectrum  $\Phi_v$  is unknown, and because  $\hat{S}_{i,i}$  indicates that data was obtained while  $C_i$  was implemented, which is not possible. Therefore we need reasonable approximations of (4.18).

Rewriting (4.18a), we see that

$$|L_{y,i}|^2 = \frac{|S_{0,i}|^2 \left| G_0 - \hat{G}_i \frac{\hat{S}_{i,i}}{S_{0,i}} \right|^2 \Phi_r + \Phi_v}{|S_{0,i-1}|^2 \left| G_0 - \hat{G}_i \frac{\hat{S}_{i,i-1}}{S_{0,i-1}} \right|^2 \Phi_r + \Phi_v} \quad (4.20)$$

and the second factor on the right-hand side of (4.20) tends to one if

$$\frac{\hat{S}_{i,i}}{S_{0,i}} = \frac{\hat{S}_{i,i-1}}{S_{0,i-1}} \quad (4.21)$$

for which a sufficient condition is that

$$\hat{S}_{i,i} = S_{0,i} \quad \hat{S}_{i,i-1} = S_{0,i-1} \quad (4.22)$$

which implies that the estimates of  $S_0$  must be consistent. This can be achieved by using high order FIR or ORTFIR estimates.

Similarly, we obtain for  $L_u$  from (4.18b)

$$|L_{u,i}|^2 = \frac{|S_{0,i}|^2 \left| 1 - \frac{\hat{S}_{i,i}}{S_{0,i}} \right|^2 \Phi_r + |C_{b,i}|^2 \Phi_v}{|S_{0,i-1}|^2 \left| 1 - \frac{\hat{S}_{i,i-1}}{S_{0,i-1}} \right|^2 \Phi_r + |C_{b,i-1}|^2 \Phi_v}. \quad (4.23)$$

If (4.22) holds, this tends to

$$|L_{u,i}|^2 = \frac{|C_{b,i}S_{0,i}|^2}{|C_{b,i-1}S_{0,i-1}|^2}. \quad (4.24)$$

To calculate the filters, we need  $C_{b,i-1}$ ,  $S_{0,i-1}$ ,  $C_{b,i}$  and  $S_{0,i}$ .

The feedback controller  $C_{b,i-1}$  is known.

Since the true  $S_{0,i-1}$  is not known, it must be approximated by a high order model for (4.22) to hold. This high order model is already available as part of the GI procedure.

The future feedback controller  $C_{b,i}$  can be approximated in an additional internal loop, in which the newly designed controller is used to calculate the filters. The iterations in this loop are indexed by  $j$ , and the corresponding controller, closest to  $C_i$ , is  $C_{i,j}$ . In this internal loop also  $\hat{G}$  and  $\hat{S}$  are updated.

The future sensitivity function  $S_{0,i}$  can be approximated by making use of a high order model of the process. This can be obtained with Indirect Identification as in (2.60). First estimate a high order model of  $T_{yr,i,j} \triangleq G_0 S_{0,i,j}$ , where the  $i$  and the  $j$  indicate the iteration step in both loops. Then a high order estimate  $\tilde{G}_{i,j}$  of  $G_0$  is obtained as

$$\tilde{G}_{i,j} = \frac{\hat{T}_{yr,i,j}}{1 - C_{b,i,j} \hat{T}_{yr,i,j}} \quad (4.25)$$

and the high order estimate of  $S_{0,j}$  is obtained as

$$\hat{S}_{i,j} = \frac{1}{1 + C_{b,i,j} \left( \frac{\hat{T}_{yr,i,j}}{1 - C_{b,i,j} \hat{T}_{yr,i,j}} \right)}. \quad (4.26)$$

Hence, the identification filters  $L_y$  and  $L_u$  are designed such that

$$|L_{y,i,j}|^2 = \frac{|\hat{S}_{i,j}|^2}{|\hat{S}_{i,i-1}|^2} \quad |L_{u,i,j}|^2 = \frac{|C_{b,i,j} \hat{S}_{i,j}|^2}{|C_{b,i-1} \hat{S}_{i,i-1}|^2} \quad (4.27)$$

where the estimates of the sensitivity functions are obtained as previously described.

To initialize the filters,  $C_{i,1}$  must be the best prediction of  $C_i$ . Hence

$$C_{i,1} = C_{i-1} \quad (4.28)$$

and, consequently,

$$L_{y,i,1} = L_{u,i,1} = 1. \quad (4.29)$$

**Remark 4.2** In the above development, noise models have not been considered. However, all derivations hold true, independent of the possible estimation of noise models, provided they are independently parametrized from the input-output models.

Since independently parametrized noise models act as the inverse of identification filters, (4.18) will have the respective noise models in the numerator and the denominator, and likewise for (4.27). There is, however, no advantage in estimating noise models.

## 4.5 Extended iterative scheme

The use of identification filters that depend on the future controller, as described in the previous section for the Zang scheme, is useful for other iterative identification and controller design schemes as well. In this section, we extend the general iterative scheme, reflected by (4.4), in such a way that the identification step incorporates control design specifications. This is accomplished by adding an internal loop to the iterative scheme.

The extended scheme that we propose is shown in Figure 4.1.

We start with an initial controller  $C_0$  implemented. At C1 the closed-loop performance is evaluated. Possible evaluation criteria are discussed in Section 4.6. If it is decided that the closed-loop performance is not sufficient, an iteration  $i$  is started to redesign the controller.

This redesign starts with the design of an experiment, which yields an excitation signal  $\{r_{t,1}\}$ . Experiment design is discussed in more detail in Chapter 5.

The data set  $\{y_{t,1}, u_{t,1}\}$  is acquired, and the closed-loop identification can be launched in the internal  $j$ -loop. At first, there is no knowledge about the future controller  $C_1$ , and therefore the model  $\hat{G}_{1,1}$  is identified without incorporating control design specifications (in the case of the Zang scheme, the filters are equal to one). Subsequent controller design provides the controller  $C_{1,1}$ .

At C2 the controller  $C_{1,1}$  is evaluated, and it is decided whether a new identification step could provide a better model in the sense of a better bias distribution, and hence a better controller. Possible criteria for C2 are discussed in Section 4.6. If it is decided to go back to the identification step, we iterate in the  $j$ -loop, until C2 is satisfied. In that case  $C_1 = C_{1,j}$ , which is the last designed controller. This controller is implemented on the process, and again the closed-loop performance is evaluated. If the performance is still not sufficient, we iterate within the  $i$ -loop, until C1 is satisfied.

To summarize, Figure 4.1 presents a general iterative scheme of identification and controller design. The  $i$ -loop is present in the existing schemes, but the internal  $j$ -loop is added to reduce the number of experiments required.

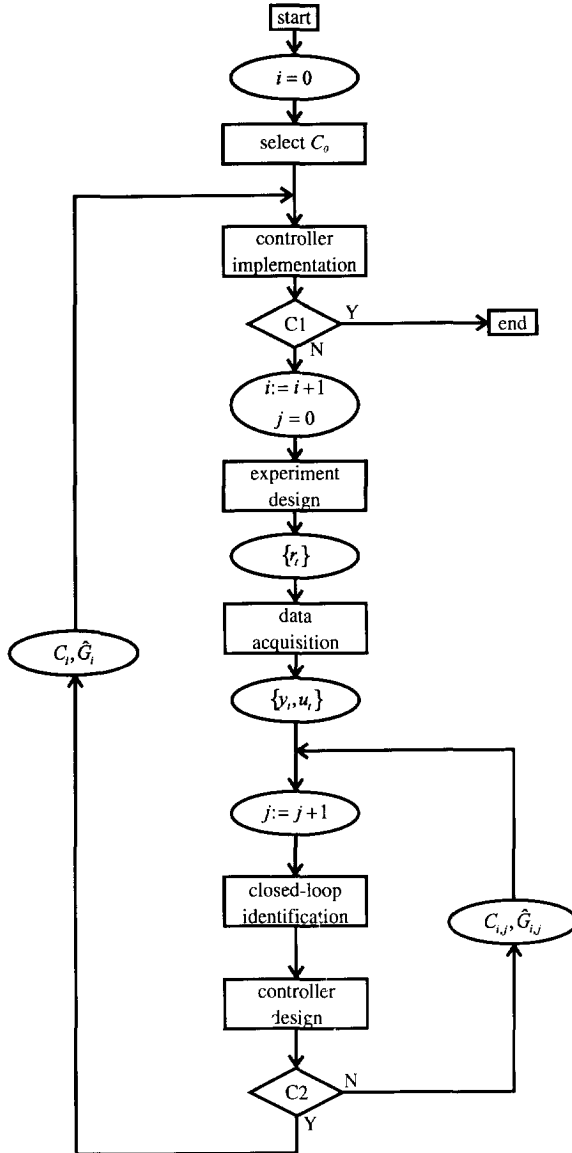

Figure 4.1. Iterative scheme of identification and control design



**Remark 4.3** In order for the  $j$ -loop to make sense, the identification stage should depend on  $C_{i,j-1}$ . In other words, the identification should be control relevant.

## 4.6 When to stop the iteration

In the iterative scheme of identification and controller design, shown in Figure 4.1, there are two iterative loops. Both loops need criteria – C1 and C2, respectively – on the basis of which it is decided to do another iteration, or to stop the iteration.

In this section we discuss several possibilities for C1 and C2. They have a monitoring task: since convergence of the scheme cannot be guaranteed, the iterations should terminate if no improvement is obtained with respect to the previous situation. Hence C1 and C2 should compare the present and the previous situation.

The external  $i$ -loop has criterion C1. This criterion should be based on the evaluation of the designed controller.

If there are prespecified demands on the performance, it should simply be checked whether these demands are met. If they are met, the iteration can be stopped, and the designed controller is satisfactory.

If the aim is to push the performance to the limits, it should be decided whether or not the performance can be improved with another iteration. This decision can be based on heuristical experience, or on the outcome of an algorithm.

We discuss two possible criteria for the latter case. The first looks at the decrease of the achieved performance cost, which should be larger than some value  $\epsilon_1 > 0$ :

$$C1_1 : \quad \left\| J^{\text{glob}}(G_0, C_{i-1}) \right\| - \left\| J^{\text{glob}}(G_0, C_i) \right\| \geq \epsilon_1. \quad (4.30a)$$

Note that, if the two-norm is used (Appendix A), C1<sub>1</sub> needs  $N \rightarrow \infty$ . In practice the values are calculated from finite-sample data sets, which means that the noise realization during each experiment should be equal. If the effect of the noise is different for each experiment, C1<sub>1</sub> does not make sense.

The second reason to stop the iteration is a decrease in difference between the current controller and the previous controller:

$$C1_2 : \quad \|C_i - C_{i-1}\| \leq \epsilon_2 \quad (4.30b)$$

with  $\epsilon_2 > 0$ .

The criterion C1 is composed of an OR operation of C1<sub>1</sub> and C1<sub>2</sub>:

$$C1 = C1_1 \vee C1_2. \quad (4.30c)$$

The criterion C2 in the internal  $j$ -loop reflects our satisfaction with the model-controller pair. The  $j$ -iteration should terminate if the controller, the model or the identification filters no longer change. This is reflected by the following criteria.

$$C2_1 : \quad \|C_{i,j} - C_{i,j-1}\| \leq \epsilon_3 \quad (4.31a)$$

$$C2_2 : \quad \|\hat{G}_{i,j} - \hat{G}_{i,j-1}\| \leq \epsilon_4 \quad (4.31b)$$

$$C2_3 : \quad \|L_{y,i,j} - L_{y,i,j-1}\| \leq \epsilon_5 \quad (4.31c)$$

with  $\epsilon_3$ ,  $\epsilon_4$  and  $\epsilon_5$  (small) positive values.

The criterion C2 is composed of either the AND or the OR operation of  $C2_1$ ,  $C2_2$  and  $C2_3$ :

$$C2 = C2_1 \wedge C2_2 \wedge C2_3 \quad (4.31d)$$

$$C2 = C2_1 \vee C2_2 \vee C2_3. \quad (4.31e)$$

The OR operation (4.31e) will, in general, result in faster termination of the  $j$ -loop. The AND operation (4.31d) is more cautious, and generally results in more  $j$ -iterations. It is likely that this will require fewer experiments.

The criterion C2 cannot be based on the upper bound in (4.2) for two reasons. First, the upper bound cannot be computed, since the controller should then be implemented, in which case there is no more need for the upper bound. Second, if the upper bound were computable, it would probably be conservative. In that case a decrease or increase of the upper bound does not indicate anything about the achieved performance cost.

Identification of model uncertainty (Helmicki *et al.*, 1991; De Vries, 1994; Hakvoort, 1994) may provide a way to compute a suitable upper bound, which is not too conservative.

## 4.7 Conclusions

In this chapter we have discussed the problem of control-relevant identification. To improve the performance of a controlled plant, the global control design objective is split into an identification part (4.4a), and a control design part (4.4b), which are solved iteratively.

The Zang scheme for iterative identification and LQ controller design has been discussed in more detail. The reason why the Generalized Identification method should be used instead of Direct Identification has been substantiated. The identification filters  $L_y$  and  $L_u$  can then be used to incorporate the future controller in the identification step, in an additional iterative loop. The filters should be designed according to (4.27), to reduce the number of experiments.

---

The internal iterative loop can be added to the other iterative schemes as well. This results in the scheme shown in Figure 4.1.

The iterations should terminate if the stop criteria, discussed in Section 4.6, become active.



## Chapter 5

---

# *Input design and model validation*

## *5.1 Introduction*

A model is built by performing mathematical operations on data. This data represents reality (the process). The amount of information about the process that is present in the data provides an upper limit for the achievable model quality. The amount of information in the data depends on the *experimental situation*, which is determined by, e.g., the sampling time, the data acquisition equipment and the input signal. *Experiment design* is concerned with the specific choices made to create a desirable experimental situation.

Once the data is obtained, (closed-loop) identification methods are applied to find a model.

Evaluation of the models is done by *model validation*. If it is decided that a model is not accepted as a representation of a process, we have to go back to one of the previous steps, and make different choices for, for example, the parametrization or the identification procedure. We might also decide to redesign the experimental situation.

A suitable identification experiment depends on the process to be identified. The sampling time must be chosen in accordance with the fastest dynamics of the process (Ljung, 1987), and an appropriate input signal depends on the process dynamics as well. Hence, to properly design an identification experiment, *a priori* knowledge of the process must be available.

The required *a priori* knowledge can be derived from operator experience, or from a previously identified model, possibly obtained from data from an initial *free-run* experiment (no input signals applied).

The choices in experiment design are limited by the availability and affordability of instrumentation, and by the possibilities where and how to excite the process. For most of these choices, rules of thumb are provided by, e.g., Ljung (1987), Backx (1987) and Zhu and Backx (1993). These are not considered here.

In this chapter, attention is focused on how to design an appropriate input signal. The

discussion of model validation is brief. We restrict our attention to an overview of existing methods, and we add a discussion on the validation of models that are obtained from closed-loop data.

The relevance of input design to the identification results can be illustrated as follows. The purpose of identification in general is to obtain an estimate  $\hat{G}$  as close to the true  $G_0$  as possible. A straightforward way to achieve this would be to minimize the distance  $G_0 - G$ . However, we have no direct access to  $G_0$ , and therefore  $\hat{G}$  is estimated indirectly by minimizing (a function of) the distance  $y(G_0) - \hat{y}(G)$ , as is done with the Prediction Error Method (2.20), where  $G$  is parametrized by a parameter vector  $\theta$ . The parameter estimate  $\hat{\theta}$  is then obtained by searching a minimum in a *landscape*. The shape of this landscape depends on the parametrization  $G$  and the input signal  $u$ . Changing either of these influences the model and the model error.

The model error consists of a bias part and a variance part. The bias part is caused by undermodeling ( $\mathcal{S} \notin \mathcal{M}$ ) and, in practice, by the finiteness of the data set. It can be influenced by prediction error prefilters  $L$ , as shown in Chapter 2. The variance part or model uncertainty is caused by the noise, acting on the process. It can be influenced by changing the parametrization and by designing an input signal. The latter is considered in this chapter.

Input design has been a research topic for several decades, and various mathematically based procedures have been developed to design an input signal (Mehra, 1974; Zarrop, 1979; Yuan and Ljung, 1984; Gevers and Ljung, 1986; Schoukens and Pintelon, 1991; Richalet, 1991). These references are used as a basis of inspiration to develop two new input design techniques.

The input design problem can be phrased as a constrained minimization problem, where the function to be minimized is a scalar function of the model uncertainty, measured in terms of the variance of the estimated parameter  $\hat{\theta}$ , or the variance of the estimated frequency function  $G(e^{i\omega}, \hat{\theta})$ . The constraints reflect maximum allowable perturbations of the process, such as a maximum input power or a maximum input amplitude.

In most cases, the optimization of the input signal  $u_t$  is not done over the entire time interval, but the input signal is parametrized by a parameter vector  $\xi$  to reduce the number of free parameters. This parameter vector is also known as the *input protocol*, and consists of all relevant aspects to determine  $u_t$ . For example,  $\xi$  contains frequencies, amplitudes and phases if  $u$  is a multisine, or  $\xi$  contains filter parameters if  $u$  is filtered white noise. The constraints can always be written as  $h(\xi) \leq 0$ , with  $h$  some (vector) function of  $\xi$ . The input design problem can then be written as

$$\xi^* = \arg \min_{\xi} V_{ED}(\hat{\theta}, \xi) \quad (5.1)$$

$$h(\xi) \leq 0$$

with  $V_{ED}(\hat{\theta}, \xi)$  the *Experiment Design* criterion, which is a scalar function of the model uncertainty and the input protocol.

In most reference works on parameter variance reduction (Federov, 1972; Mehra, 1974, 1981; Goodwin and Payne, 1977; Zarrop, 1979; Gevers and Ljung, 1986; Schoukens and Pintelon, 1991), use is made of Fisher's information matrix, which determines the Cramèr-Rao bound as the minimum achievable parameter variance for an estimator. By minimizing a function of this lower bound, the parameter variance is reduced as well. Typical functions are the determinant, the trace, and the ratio of the largest and smallest eigenvalues (condition number) of the Fisher information matrix (Mehra, 1974, 1981), with the experiment carried out in open loop. However, the computation of the Fisher information matrix is a very difficult task for nonlinear parametrizations.

In this chapter, two new input design procedures are proposed that are related to Richalet's *global identification* approach (1991). The starting point is that uncertainty regions can be determined around the parameter estimate. Their shape depends on the Hessian (second derivative) of the identification criterion. The Hessian is then used for input design. The input design methods are computationally less involved, fairly easily implemented, and they have a nice geometric interpretation.

The relationship between the Hessian of the identification and the variance of the estimate is discussed in Section 5.2. A geometric interpretation is given of the uncertainty regions, and the role of the Hessian. By improving the conditioning of the identification problem, the search algorithm has faster convergence, and it appears that the estimate has smaller variance.

The "parametrization" of the input signals as input protocols is discussed in Section 5.3 for several classes of input signals. For each of these classes, it is shown what parameters are contained in  $\xi$ .

In Section 5.4, an input design procedure is proposed that is aimed at reducing the variance of the parameter estimate  $\hat{\theta}$  for continuous-time parametrizations. It can be viewed as a frequency-domain counterpart of (Richalet *et al.*, 1991).

If the intended model application, controller design, is taken into account, it is more natural to look at the variance of the frequency function  $\hat{G}(e^{i\omega})$ , since control performance is often dependent on frequency-domain measures, such as bandwidth. For high-performance control, the model should have, e.g., a small bias and a small variance in the region of the closed-loop crossover frequency. This is not a property of the parameters  $\hat{\theta}$ , but of the frequency function. It can even be shown (Gevers and Ljung, 1986) that when a minimum variance controller is designed, the experiment should be carried out in closed loop, and a smaller variance of the parameters does not lead to a better control performance!

Hence, in Section 5.5 an input design procedure is developed for open-loop that reduces the

variance of the frequency function. In Section 5.6 the results are extended to closed-loop identification.

The proposed procedures contain weighting matrices, which can be used to tailor the variance reduction. For instance, the reduction of the variance of one specific parameter can be made relatively more important than reducing the variance of the other parameters. In Section 5.7, the choice of these weighting matrices is considered.

In Section 5.8, the choice of the location of the external excitation signal is discussed. Several questions that determine this choice are posed and answered. Model validation is discussed in Section 5.9, and Section 5.10 contains the conclusions of the chapter.

## 5.2 The use of the Hessian for input design

The basic idea behind the input design methods developed in this chapter is known as *global identification* (Richalet, 1991). Besides a *local* parameter estimate  $\hat{\theta}$ , also an uncertainty region around  $\hat{\theta}$  is calculated. This uncertainty region is determined by the contour lines of the identification criterion, denoted as the *iso-V*s. An *iso-V* is a hypersurface in the parameter space, for which the value of the identification criterion is equal. Its shape and volume are determined by the Hessian (second derivative) of the identification criterion with respect to the parameters.

In this section, we show that an implicit assumption in the global identification approach is that  $S \in \mathcal{M}$ . Under this assumption the uncertainty region is an *iso-V*, and the Hessian of the identification criterion can be used for input design.

If  $S \notin \mathcal{M}$ , there is also an influence of the gradient of the identification criterion on the uncertainty interval. Still the relationship between the uncertainty regions and the *iso-V*s can be used for input design.

Let  $\hat{\theta}$  be the parameter estimate (or local model), determined as the minimizing argument of the identification criterion  $V_N(\theta)$

$$\hat{\theta} \triangleq \arg \min_{\theta \in \Theta} V_N(\theta) \quad (5.2)$$

and let  $\theta_\infty$  be the limit model, minimizing  $V_\infty(\theta)$ . Ljung (1987) shows that

$$\sqrt{N}(\hat{\theta} - \theta_\infty) \in As\mathcal{N}(0, P) \quad (5.3)$$



which means that  $\sqrt{N}(\hat{\theta} - \theta_\infty)$  converges in distribution to the normal distribution with mean 0 and variance  $P$ , which is given by

$$P = [V_{\infty, \theta\theta}(\theta_\infty)]^{-1} Q [V_{\infty, \theta\theta}(\theta_\infty)]^{-1} \quad (5.4)$$

where  $V_{\infty, \theta\theta}$  is the Hessian of  $V_\infty$  with respect to  $\theta$ , and with

$$Q = \lim_{N \rightarrow \infty} N \mathbb{E} \{ V_{N, \theta}(\theta_\infty) [V_{N, \theta}(\theta_\infty)]' \} \quad (5.5)$$

where  $V_{N, \theta}$  is the gradient of  $V_N$  with respect to  $\theta$ . The uncertainty ellipsoids around  $\theta_\infty$  are defined as

$$(\theta_\infty - \hat{\theta})' P^{-1} (\theta_\infty - \hat{\theta}) = \text{constant} \quad (5.6)$$

and an iso- $V$  is defined as

$$(\theta_\infty - \hat{\theta})' V_{\infty, \theta\theta}(\theta_\infty) (\theta_\infty - \hat{\theta}) = \text{constant}. \quad (5.7)$$

Comparing (5.6) and (5.7), we see that an uncertainty interval is an iso- $V$  if  $P^{-1} \sim V_{\infty, \theta\theta}(\theta_\infty)$ .

**Remark 5.1** Both (5.6) and (5.7) are based on second order Taylor expansions of  $V_\infty$ . Consequently, these expressions are only second order approximations of the actual uncertainty region and iso- $V$ . The validity of (5.6) and (5.7) is therefore restricted to the neighborhood of  $\theta_\infty$ .

Ljung (1987) distinguishes two cases.

If  $S \in \mathcal{M}$ ,

$$P = [V_{\infty, \theta\theta}(\theta_\infty)]^{-1} \sigma_e^2 \quad (5.8)$$

with  $\sigma_e^2$  the variance of the additive white noise disturbance.

In this case an uncertainty interval is an iso- $V$ , and the Hessian of the identification criterion directly determines the size and the orientation of the uncertainty interval.

If  $S \notin \mathcal{M}$ , but  $G_0 \in \mathcal{G}$  and  $G$  and  $H$  are independently parametrized by  $\theta$  and  $\beta$ , respectively, we have

$$P = \left[ \mathbb{E} \psi_t \psi_t' \right]^{-1} \mathbb{E} \tilde{\psi}_t \tilde{\psi}_t' \left[ \mathbb{E} \psi_t \psi_t' \right]^{-1} \sigma_e^2 \quad (5.9a)$$

with

$$\psi_t = - \left[ \frac{\partial \epsilon}{\partial \theta} \right]' \quad (5.9b)$$

$$\tilde{\psi}_t = \sum_{i=0}^{\infty} f_i \psi_{t+i} \quad (5.9c)$$

and  $\tilde{\psi}$  is an anti-causally filtered version of  $\psi$ . The filter  $F(z)$  is given by

$$F(z) = \frac{H_0(z)}{H(z, \beta_\infty)} = \sum_{i=0}^{\infty} f_i z^{-i} \quad (5.10)$$

which clearly depends on the noise characteristics.

Consequently, in this case not only the Hessian, but also the noise characteristics determine the size and shape of the uncertainty interval.

**Remark 5.2** If  $S \in \mathcal{M}$ ,  $F(z) \equiv 1$  and (5.9a) is in agreement with (5.8).

**Remark 5.3** If an OE parametrization is used,  $H(z, \beta_\infty) \equiv 1$ , and  $F(z) = H_0(z)$ .

The influence of the noise characteristics on the uncertainty interval can be made more explicit as follows. Define  $X$  and  $\tilde{X}$  as

$$X = \begin{bmatrix} \psi'_0 \\ \psi'_1 \\ \vdots \\ \psi'_N \end{bmatrix} \quad \tilde{X} = \begin{bmatrix} \tilde{\psi}'_0 \\ \tilde{\psi}'_1 \\ \vdots \\ \tilde{\psi}'_N \end{bmatrix} \quad (5.11)$$

and let the block Toeplitz matrix  $\mathcal{F}$  be constructed from the impulse response of  $F(z)$ :

$$\mathcal{F} = \begin{bmatrix} f_0 & f_1 & \cdots & f_N \\ 0 & f_0 & \cdots & f_{N-1} \\ \vdots & \ddots & \ddots & \vdots \\ 0 & \cdots & 0 & f_0 \end{bmatrix}. \quad (5.12)$$

Then we have

$$\tilde{X} = \mathcal{F}X \quad (5.13)$$

and

$$\bar{\mathbb{E}}\psi_t\psi_t' = X'X \quad (5.14)$$

$$\bar{\mathbb{E}}\tilde{\psi}_t\tilde{\psi}_t' = \tilde{X}'\tilde{X} = X'\mathcal{F}'\mathcal{F}X \quad (5.15)$$

and, consequently,

$$P = [X'X]^{-1}X'\mathcal{F}'\mathcal{F}X[X'X]^{-1}\sigma_e^2. \quad (5.16)$$

Since  $X'X$  is the Hessian of the identification criterion, its properties determine the shape of the uncertainty interval. The Hessian depends on the input signal, and hence it can be used for input design. Only if  $S \in \mathcal{M}$  is the relationship between the Hessian and the uncertainty interval one-to-one. In all other cases it is approximative.

The above derivation considers the parameter uncertainty. Since a model is just an intermediate to arrive at a controller, the quality of a model cannot be measured by the parameter variance only. Reduced parameter variance does not automatically imply improved control performance, and a more control-relevant measure is the variance of the frequency function of the model (Gevers and Ljung, 1986).

An asymptotic expression for the variance of the frequency function follows from (5.8), by assuming that a model is identified with  $d \rightarrow \infty$  (and hence  $S \in \mathcal{M}$ ) (Yuan and Ljung, 1984; Ljung, 1985, 1987):

$$\text{var} \left\{ G(e^{i\omega}, \hat{\theta}) \right\} \sim \frac{d}{N} \frac{\Phi_v(\omega)}{\Phi_u(\omega)}. \quad (5.17)$$

The condition  $d \rightarrow \infty$  ensures that there is no correlation between different points of the frequency function estimate. For finite model order Ljung (1987) has shown that (5.17) is only approximately valid. For input design a more suitable expression must be derived.

To derive a suitable expression for the frequency function variance for finite  $d$ , we follow the same line of reasoning as in the parameter variance case.

If we define a vector that contains points of the frequency function estimate, we can define an uncertainty ellipsoid around it, as in the parameter variance case. This uncertainty ellipsoid coincides with an iso- $V$ , if  $S \in \mathcal{M}$ . The iso- $V$  depends on the Hessian of the

identification criterion with respect to the frequency function. This Hessian determines the size and shape of the iso- $V$ , and can be used for input design.

The iso- $V$  for the frequency function can be interpreted as follows.

Consider the Nyquist diagram of an arbitrary loop transfer function  $\hat{G}C$ , shown in Figure 5.1a. The dotted lines are the uncertainty intervals for different frequencies  $\omega_j$ . The

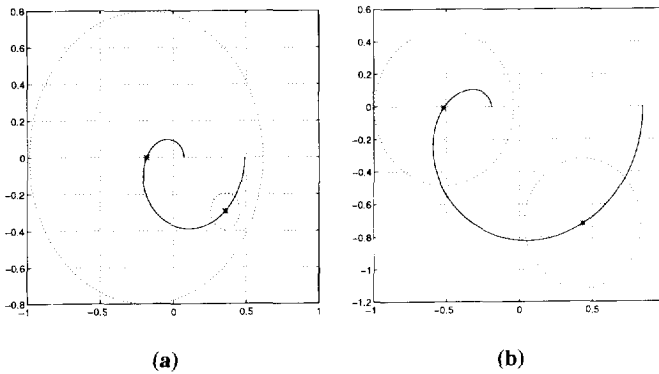

Figure 5.1. Nyquist diagram (solid) and uncertainty intervals (dotted) of a loop transfer function  $\hat{G}C$  for different uncertainty distributions

stability margin for the closed-loop system is determined by the distance between the Nyquist plot and the point  $(-1, 0)$ . The large uncertainty in this area implies that, to have guaranteed stability, the distance to  $(-1, 0)$  must be large, which in general results in low designed performance.

Increasing the sensitivity of the identification criterion in this area results in a smaller uncertainty, at the cost of a larger uncertainty for other frequencies. Consequently, the performance can be improved with still guaranteed stability (Figure 5.1b).

The sensitivity of the identification criterion with respect to points of the frequency function is reflected by the Hessian of the identification criterion with respect to those same points. Hence for input design the Hessian can be used, not with respect to the parameters, but with respect to points of the frequency function. Note that the choice of the frequencies, at which the uncertainty is evaluated, influences the final result.

To conclude, for input design we use the Hessian of the identification criterion, either with respect to the parameters, or with respect to points of the frequency function. We will denote the Hessian by  $V_{xx}$ , where  $x$  is either the parameter vector, or a vector of points of the frequency function.

Scalar functions of the Hessian can be used in the optimization problem (5.1). We discuss

candidate functions that depend on the determinant, the eigenvalues, the singular values, the condition number or the trace of the Hessian.

The iso- $V$ s are ellipses, given by (5.7). The volume of the iso- $V$  depends on the determinant of the Hessian: the larger the determinant, the smaller the volume. Therefore, a possible input design criterion is the maximization of the determinant of the Hessian:

$$\xi^* = \arg \max_{\substack{\xi \\ h(\xi) \leq 0}} \det(V_{xx}(\hat{\theta}, \xi)). \quad (5.18)$$

The largest axis of an iso- $V$  corresponds to the smallest eigenvalue  $\lambda_{\min}$  of  $V_{xx}$ , and the smallest axis corresponds to the largest eigenvalue  $\lambda_{\max}$ . Consequently, if  $\lambda_{\min}$  is increased, the largest axis becomes smaller, and the uncertainty in that direction decreases. Hence an input design criterion can be the maximization of the smallest eigenvalue  $\lambda_{\min}$ :

$$\xi^* = \arg \max_{\substack{\xi \\ h(\xi) \leq 0}} \lambda_{\min}(V_{xx}(\hat{\theta}, \xi)). \quad (5.19)$$

This also gives an interpretation of the determinant criterion (5.18). The determinant is the product of the eigenvalues. Hence, if the determinant increases, this product is increased, and the resulting iso- $V$  has a smaller volume.

Since the Hessian is symmetric and positive definite, the eigenvalues equal the singular values. Therefore (5.19) is equivalent to maximizing the smallest singular value of  $V_{xx}$  (or minimizing the largest singular value of  $V_{xx}^{-1}$ , which is a norm).

The condition number of  $V_{xx}$  is not a good criterion, since the same condition number can be realized with different sets of eigenvalues. However, maximizing the smallest eigenvalue will in general decrease the condition number.

The trace of the inverse of the Hessian reflects the inverse of the sensitivity of the identification criterion with respect to the parameters. Therefore, minimizing the trace of the inverse of the Hessian can be used to determine an input signal:

$$\xi^* = \arg \min_{\substack{\xi \\ h(\xi) \leq 0}} \text{tr}(V_{xx}^{-1}(\hat{\theta}, \xi)). \quad (5.20)$$

**Example 5.1** To illustrate the effect of the different criteria, we present an example where we have taken arbitrary symmetric positive definite matrices as the Hessian  $V_{xx}$ . The example consists of two parameters, and the iso- $V$ s are shown for a specific value of

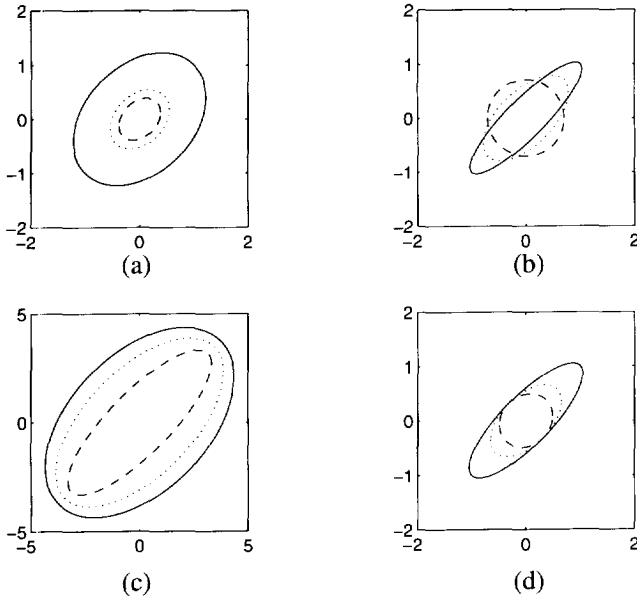

Figure 5.2. Iso-Vs for different experiments

| Exp. | type   | Det    | $\lambda_{\min}$ | $\lambda_{\max}$ | Cond   | trace(inv) |
|------|--------|--------|------------------|------------------|--------|------------|
| a    | solid  | 2      | 1                | 2                | 2      | 1.5        |
|      | dotted | 50     | 5                | 10               | 2      | 0.3        |
|      | dashed | 200    | 10               | 20               | 2      | 0.15       |
| b    | solid  | 16     | 1                | 16               | 16     | 1.0625     |
|      | dotted | 16     | 2                | 8                | 4      | 0.625      |
|      | dashed | 16     | 4                | 4                | 1      | 0.5        |
| c    | solid  | 0.0143 | 0.0833           | 0.3333           | 2.8    | 19         |
|      | dotted | 0.0278 | 0.0714           | 0.2              | 4      | 15         |
|      | dashed | 0.1    | 0.1              | 1                | 10     | 11         |
| d    | solid  | 10     | 1                | 10               | 10     | 1.1        |
|      | dotted | 30     | 3                | 10               | 3.3333 | 0.4333     |
|      | dashed | 70     | 7                | 10               | 1.286  | 0.2429     |

Table 5.1. Experiment data

$V(\theta)$  in Figure 5.2. For each experiment we show three iso- $V$ s, for different situations. The values of the determinant, the eigenvalues, the condition number and the trace of the inverse are shown in Table 5.1. Experiment a shows the effect of increasing the determinant of  $V_{xx}$ , while the condition number remains the same. The volume of the iso- $V$  is reduced, while the orientation does not change.

In experiment b the determinant is kept the same, but  $\lambda_{\min}$  is increased, which results in a smaller condition number. From Figure 5.2b, it follows that the volume of the iso- $V$  remains the same, but it becomes more spherical.

Experiment c shows the effect of decreasing the trace of the inverse of the Hessian. The total volume decreases by increasing the sensitivity of the identification criterion in the parameter directions.

Experiments a, b and c show that by manipulating one specific property of  $V_{xx}$ , the other properties change as well.

Finally, experiment d shows the effect of increasing the smallest eigenvalue, while keeping the largest eigenvalue constant. The smallest axis of the iso- $V$  remains equal in size and orientation, while the largest axis becomes smaller.  $\triangle$

This example illustrates the use of the determinant, the smallest eigenvalue or the trace of the inverse of  $V_{xx}$  in the input design problem.

In all cases, the Hessian should be evaluated in  $\theta_{\infty}$ . Since  $\theta_{\infty}$  is unknown, the evaluation is done in an initial estimate  $\theta_{\text{init}}$ .

Weighting matrices  $W$  can be introduced to reflect the relative importance of parameters or points of the frequency function. The discussion of these weighting matrices is postponed to Section 5.7.

## 5.3 Input protocols

An input protocol  $\xi$  contains all relevant parameters that uniquely define an input signal. The protocols are given for input signals that are a multisine, filtered white noise and Generalized Binary Noise (Tulleken, 1990, 1992).

### 5.3.1 Multisine

A multisine input signal is given by

$$u_t = \sum_{j=1}^M A_j \sin(\omega_j t + \phi_j) \quad (5.21)$$

with  $A_j$  the amplitude,  $\omega_j$  the radial frequency and  $\phi_j$  the phase of each sinusoid. The input protocol contains all relevant parameters to define  $u_t$ , and therefore

$$\xi = \left( A_1 \ \omega_1 \ \phi_1 \ A_2 \ \omega_2 \ \phi_2 \ \cdots \ A_M \ \omega_M \ \phi_M \right)'. \quad (5.22)$$

### 5.3.2 Filtered white noise

A filtered white noise input signal consists of a Zero Mean White Noise signal  $e_t$  with unit variance, filtered through an ARMA filter  $F_u(z)$ :

$$u_t = F_u(q)e_t \quad (5.23a)$$

$$F_u(z) = K_u \frac{1 + c_1 z^{-1} + c_2 z^{-2} + \dots + c_{n_c} z^{-n_c}}{1 + d_1 z^{-1} + d_2 z^{-2} + \dots + d_{n_d} z^{-n_d}}. \quad (5.23b)$$

This signal is completely defined by the filter parameters, and therefore

$$\xi = \left( K_u \ c_1 \ c_2 \ \cdots \ c_{n_c} \ d_1 \ d_2 \ \cdots \ d_{n_d} \right)'. \quad (5.24)$$

### 5.3.3 Generalized Binary Noise (GBN)

The Generalized Binary Noise (GBN) signal is introduced by Tulleken (1990, 1992). It switches randomly between two levels  $A$  and  $-A$ , with *nonswitching probability*  $p$ .

A GBN signal is completely characterized by  $A$ ,  $p$ , the *switching time*  $T_{sw}$  and the *basic switching time*  $T_b$ .

The switching time  $T_{sw}$  is the time between two successive switches. It is a stochastic variable. The basic switching time  $T_b$  is the smallest possible switching time.

A discrete-time GBN signal is defined on a discrete time grid, and hence  $T_{sw} = nT_b$ , with  $n$  an integer.

Since  $T_{sw}$  is a stochastic variable, the *expected switching time* is  $\mathbb{E}\{T_{sw}\}$ . The relationship between  $\mathbb{E}\{T_{sw}\}$ ,  $T_b$  and  $p$  is (Tulleken, 1992)

$$\mathbb{E}\{T_{sw}\} = \frac{T_b}{1-p}. \quad (5.25)$$



The spectrum of a GBN signal is given by

$$\Phi(\omega) = \frac{A^2(1 - q^2)T_b}{1 - 2q \cos(\omega T_b) + q^2} \quad -\pi/T_b \leq \omega \leq \pi/T_b \quad (5.26)$$

with

$$q = 2p - 1. \quad (5.27)$$

Note that for a Pseudo-Random Binary Sequence (PRBS),  $p = 1/2$ , and hence  $\Phi_u(\omega) = A^2 T_b$ .

In Figure 5.3 the spectrum  $\Phi(\omega)$  of a GBN signal is shown, for different values of the nonswitching probability  $p$ , but the same value of  $T_b$  and  $A$ . It can be seen that for  $p < 1/2$ ,

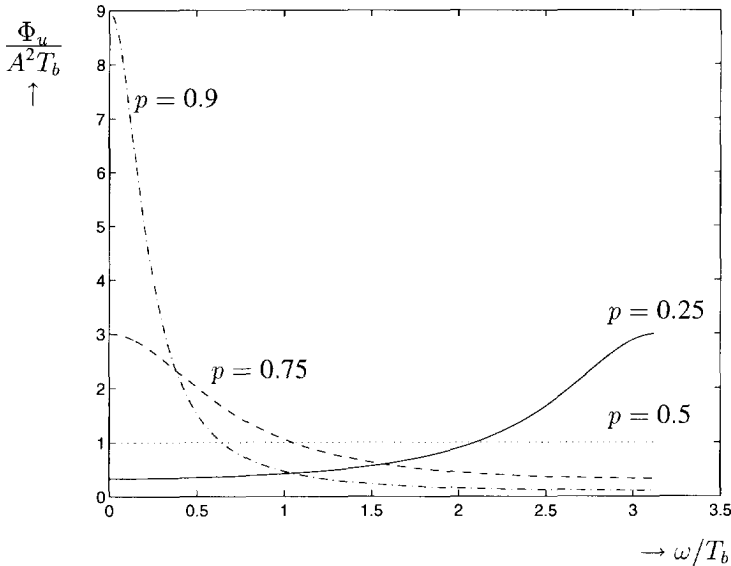

Figure 5.3. Spectrum of a GBN signal, for different values of  $p$

the signal has more power in the high frequencies. For  $p > 1/2$ , the low-frequency part of the signal has more power.

The design variables of a GBN are  $A$ ,  $p$  and  $T_b$ , and therefore

$$\xi = (A \quad p \quad T_b)'. \quad (5.28)$$

The basic switching time  $T_b$  is usually chosen in accordance with the smallest time constant of the process to be identified, or it is dictated by the equipment.

## 5.4 Optimal input design for parameter variance reduction

In this section, a specific procedure is developed to design an input signal for frequency-domain identification of continuous-time systems. The Sanathanan and Koerner iteration (1963), which is an iterative refinement of Levy's method (1959), is used to identify the model

$$G(i\omega, \theta) = \frac{B(i\omega, \theta)}{A(i\omega, \theta)} = \frac{\sum_{j=0}^{n_b} b_j (i\omega)^j}{1 + \sum_{j=1}^{n_a} a_j (i\omega)^j}. \quad (5.29)$$

Denoting the iteration by  $k$ , the estimate  $\hat{\theta}_k$  is obtained as

$$\hat{\theta}_k = \arg \min_{\theta \in \Theta} V_k(\theta, \xi) \quad (5.30)$$

$$V_k(\theta, \xi) = \sum_{j=1}^M \left( \frac{A(i\omega_j, \theta)Y(i\omega_j, \xi) - B(i\omega_j, \theta)U(i\omega_j, \xi)}{A(i\omega_j, \hat{\theta}_{k-1})} \right)^2 \quad (5.31)$$

with  $Y(i\omega, \xi)$  and  $U(i\omega, \xi)$  the Fourier transformed signals  $y_t$  and  $u_t$ , respectively, and  $M$  the number of frequency-domain measurements.

The Hessian  $V_{\theta\theta}(\theta)$  of (5.31) with respect to  $\theta$  for any single  $\omega_j$  is easily calculated as

$$V_{\theta\theta}(\omega_j, \xi) = \begin{bmatrix} \frac{\partial^2 V(\omega_j, \xi)}{\partial a_1^2} & \dots & \frac{\partial^2 V(\omega_j, \xi)}{\partial a_1 \partial a_{n_a}} & \frac{\partial^2 V(\omega_j, \xi)}{\partial a_1 \partial b_1} & \dots & \frac{\partial^2 V(\omega_j, \xi)}{\partial a_1 \partial b_{n_b}} \\ \vdots & \ddots & \vdots & \vdots & \ddots & \vdots \\ \frac{\partial^2 V(\omega_j, \xi)}{\partial a_{n_a} \partial a_1} & \dots & \frac{\partial^2 V(\omega_j, \xi)}{\partial a_{n_a}^2} & \frac{\partial^2 V(\omega_j, \xi)}{\partial a_{n_a} \partial b_1} & \dots & \frac{\partial^2 V(\omega_j, \xi)}{\partial a_{n_a} \partial b_{n_b}} \\ \hline \frac{\partial^2 V(\omega_j, \xi)}{\partial b_1 \partial a_1} & \dots & \frac{\partial^2 V(\omega_j, \xi)}{\partial b_1 \partial a_{n_a}} & \frac{\partial^2 V(\omega_j, \xi)}{\partial b_1^2} & \dots & \frac{\partial^2 V(\omega_j, \xi)}{\partial b_1 \partial b_{n_b}} \\ \vdots & \ddots & \vdots & \vdots & \ddots & \vdots \\ \frac{\partial^2 V(\omega_j, \xi)}{\partial b_{n_b} \partial a_1} & \dots & \frac{\partial^2 V(\omega_j, \xi)}{\partial b_{n_b} \partial a_{n_a}} & \frac{\partial^2 V(\omega_j, \xi)}{\partial b_{n_b} \partial b_1} & \dots & \frac{\partial^2 V(\omega_j, \xi)}{\partial b_{n_b}^2} \end{bmatrix} \quad (5.32)$$

with

$$\frac{\partial^2 V(\omega, \xi)}{\partial a_j \partial a_\ell} = \frac{[(-1)^j + (-1)^\ell] (i\omega)^{j+\ell} |G_0(i\omega)|^2 \Phi_u(\omega, \xi)}{|A(i\omega, \theta_{\text{init}})|^2} \quad (5.33a)$$

$$\frac{\partial^2 V(\omega, \xi)}{\partial a_j \partial b_\ell} = \frac{-(i\omega)^{j+\ell} [(-1)^j G_0(-i\omega) + (-1)^\ell G_0(i\omega)] \Phi_u(\omega, \xi)}{|A(i\omega, \theta_{\text{init}})|^2} \quad (5.33b)$$

$$\frac{\partial^2 V(\omega, \xi)}{\partial b_j \partial b_\ell} = \frac{[(-1)^j + (-1)^\ell] (i\omega)^{j+\ell} \Phi_u(\omega, \xi)}{|A(i\omega, \theta_{\text{init}})|^2} \quad (5.33c)$$

where  $\theta_{\text{init}}$  is an initial estimate of  $\theta$ , and  $G_0$  should be replaced by the estimate  $\hat{G}(\theta_{\text{init}})$  to make the problem solvable.

Since (5.32) holds for any single  $\omega_j$ , the Hessian  $V_{\theta\theta}(\theta_{\text{init}})$  is the summation over the frequencies  $\omega_j$  of (5.32):

$$V_{\theta\theta}(\theta_{\text{init}}, \xi) = \sum_{j=1}^M V_{\theta\theta}(\omega_j, \theta_{\text{init}}, \xi). \quad (5.34)$$

Van der Klauw *et al.* (1994c) investigate the use of the different criteria, mentioned in Section 5.2, for this parametrization and the Sanathanan-Koerner iteration. They propose the use of a multisine as input signal, and the input protocol  $\xi$  thus consists of  $A_j$ ,  $\omega_j$  and  $\phi_j$ ,  $j = 1, \dots, M$ .

The parameters  $A_j$  and  $\omega_j$  are determined as in (5.1). The phases  $\phi_j$  do not influence  $\Phi_u$ , and therefore do not influence the Hessian either. They can be chosen such that a time-domain aspect of the signal, for example the maximum amplitude, is optimized (Schoukens and Pintelon, 1991).

## 5.5 Input design for frequency function variance reduction

The argumentation given in Section 5.2, to measure the model quality in terms of the variance of the frequency function, is the reason for the development in this section of an input design procedure that uses the Hessian of the identification criterion with respect to the frequency function. An expression is derived for this Hessian for open-loop identification. The way in which an optimal input signal can be determined is shown, and two simple examples illustrate the proposed procedure. In the next section the results are extended toward closed-loop identification.

The derivations are asymptotic in  $N$  ( $N \rightarrow \infty$ ), but not in  $d$ , and only SISO systems are considered. Moreover, it is assumed that  $G$  and  $H$  are independently parametrized, so the derivations hold for FIR, OE and BJ models only.

Since the frequency function  $\hat{G}(e^{i\omega})$  is a complex function, the determination of the Hessian implies differentiation with respect to  $\hat{G}$  and its complex conjugate (see Appendix A).

This complicates the derivations unnecessarily, and without loss of generality we use a real-valued vector  $\Gamma$ , defined as

$$\Gamma(\omega) \triangleq \left( \operatorname{Re}\{G(e^{i\omega})\} \quad \operatorname{Im}\{G(e^{i\omega})\} \right)' \quad (5.35)$$

and likewise for  $\Gamma_0$ .

The Hessian is determined with respect to several points of the frequency function, collected in the vector  $\gamma$ :

$$\gamma \triangleq \left( \Gamma'(\omega_1) \quad \Gamma'(\omega_2) \quad \cdots \quad \Gamma'(\omega_m) \right)' \quad (5.36)$$

To have a bijective relationship between  $\theta$  and  $\gamma$ , the dimension of  $\gamma$  is  $d$ , and the  $m$  frequencies  $\omega_j$  are all different with  $0 \leq \omega_j < \pi$ , and  $m = \operatorname{ent}(d/2)$ , which is the largest integer such that  $m \leq d/2$ .

If  $d$  is even,  $\omega_j$  is nonzero. If  $d$  is odd, the zero frequency is added, and  $G(e^{i0}) = G(1)$  (which is real) is added, such that  $\gamma$  is always a  $d$ -vector.

The general differentiation rules of Appendix A now apply.

### 5.5.1 Derivation of the Hessian

Asymptotically, the open-loop identification criterion, with independently parametrized process model  $G(\theta)$  and noise model  $H(\beta)$ , and identification filter  $L$ , is given by (2.21) as

$$V_\infty(\theta, \beta) = \overline{\mathbb{E}}\{[LH^{-1}(\beta)(y_t - G(\theta)u_t)]^2\} \quad (5.37a)$$

$$= \frac{1}{2\pi} \int_{-\pi}^{\pi} |LH^{-1}(\beta)|^2 (|G_0 - G(\theta)|^2 \Phi_u + \Phi_v) d\omega \quad (5.37b)$$

$$= \frac{1}{2\pi} \int_{-\pi}^{\pi} |LH^{-1}(\beta)|^2 (|\Gamma_0 - \Gamma(\theta)|^2 \Phi_u + \Phi_v) d\omega \quad (5.37c)$$

where  $|x|^2$  is the squared length of the vector  $x$  (see Appendix A). For reasons of readability we omit the subscript  $\infty$  in the sequel.

An expression for the Hessian of  $V$  with respect to  $\gamma$ ,  $V_{\gamma\gamma}$ , is derived by making use of the chain rule for differentiation. First a relationship is established between  $V_{\gamma\gamma}$  and  $V_{\theta\theta}$ , and then an expression is derived for  $V_{\theta\theta}$ .

For the sake of convenience, the dimensions of the matrices are sometimes explicitly written below them.

From the chain rule for differentiation (Appendix A) we have

$$\underbrace{\frac{\partial V}{\partial \theta}}_{1 \times d} = \underbrace{\frac{\partial V}{\partial \gamma}}_{1 \times d} \underbrace{\frac{\partial \gamma}{\partial \theta}}_{d \times d} \quad (5.38)$$

or, in short-hand notation

$$V_\theta = V_\gamma \gamma_\theta. \quad (5.39)$$

Consequently,

$$\underbrace{V_{\theta\theta}}_{d \times d} = \underbrace{V_\gamma}_{1 \times d} \underbrace{\gamma_{\theta\theta}}_{d \times d \times d} + \underbrace{\gamma'_\theta}_{d \times d} \underbrace{V_{\gamma\gamma}}_{d \times d} \quad (5.40)$$

and

$$\underbrace{V_{\gamma\theta}}_{d \times d} = \underbrace{V_\gamma}_{1 \times d} \underbrace{\gamma_{\gamma\theta}}_{d \times d \times d} + \underbrace{\gamma'_\theta}_{d \times d} \underbrace{V_{\gamma\gamma}}_{d \times d}. \quad (5.41)$$

Note that

$$V_{\gamma\theta} = V'_{\theta\gamma} \quad , \quad V_{\gamma\gamma} = V'_{\gamma\gamma}. \quad (5.42)$$

Moreover,

$$\gamma_{\gamma\theta} = \gamma'_{\theta\gamma} = \left[ \frac{\partial}{\partial \theta} \left( \frac{\partial \gamma}{\partial \gamma} \right) \right]' = \left[ \frac{\partial}{\partial \theta} (I_d) \right]' = \mathbf{0}_{d \times d \times d} \quad (5.43)$$

and hence the first term of the right-hand side of (5.41) vanishes. Combining (5.40) and (5.41) yields

$$V_{\theta\theta} = V_\gamma \gamma_{\theta\theta} + \gamma'_\theta V_{\gamma\gamma} \gamma_\theta. \quad (5.44)$$

If the Hessian is evaluated in the limit model  $\theta_\infty$ , by definition  $V_\theta(\theta_\infty) = 0$ , and (5.44) becomes

$$V_{\theta\theta}(\theta_\infty) = \gamma'_\theta(\theta_\infty) V_{\gamma\gamma}(\theta_\infty) \gamma_\theta(\theta_\infty) \quad (5.45)$$

Since the mapping from  $\theta$  to  $\gamma$  is bijective,  $\gamma_\theta$  is invertible. Hence  $V_{\gamma\gamma}$  can be calculated as

$$V_{\gamma\gamma}(\theta_\infty) = [\gamma_\theta^{-1}(\theta_\infty)]' V_{\theta\theta}(\theta_\infty) \gamma_\theta^{-1}(\theta_\infty). \quad (5.46)$$

We have thus established a relationship between the Hessian of  $V$  with respect to  $\gamma$  and the Hessian of  $V$  with respect to  $\theta$ . They are related through  $\gamma_\theta$ , which depends on the definition of  $\theta$ .

The final step in the calculation of  $V_{\gamma\gamma}$  is to derive an expression for  $V_{\theta\theta}$ . To this end we start off with the frequency-domain expression (5.37c). The gradient of  $V$  with respect to  $\theta$  can be calculated as

$$\underbrace{V_\theta}_{1 \times d} = \frac{-1}{\pi} \int_{-\pi}^{\pi} |LH^{-1}|^2 \underbrace{(\Gamma_0 - \Gamma)'}_{1 \times 2} \underbrace{\Gamma_\theta}_{2 \times d} \Phi_u d\omega. \quad (5.47)$$

The second derivative can be calculated as

$$\underbrace{V_{\theta\theta}}_{d \times d} = \frac{1}{\pi} \int_{-\pi}^{\pi} |LH^{-1}|^2 \left\{ \underbrace{\Gamma'_\theta}_{d \times 2} \underbrace{\Gamma_\theta}_{2 \times d} - \underbrace{(\Gamma_0 - \Gamma)'}_{1 \times 2} \underbrace{\Gamma_{\theta\theta}}_{2 \times d \times d} \right\} \Phi_u d\omega. \quad (5.48)$$

Assuming that  $\mathcal{S} \in \mathcal{M}$ , we have  $G(\theta_\infty) = G_0$ . Then  $\Gamma_0 = \Gamma(\theta_\infty)$ , and we obtain

$$V_{\theta\theta}(\theta_\infty) = \frac{1}{\pi} \int_{-\pi}^{\pi} |LH^{-1}|^2 \Gamma'_\theta(\theta_\infty) \Gamma_\theta(\theta_\infty) \Phi_u d\omega. \quad (5.49)$$

Note that for an FIR parametrization,  $\Gamma_{\theta\theta} = 0$ , and (5.49) holds even if  $\mathcal{S} \notin \mathcal{M}$ .

To summarize, the Hessian  $V_{\gamma\gamma}(\theta_\infty)$  can be calculated according to (5.46) from  $\gamma_\theta$ , and from  $V_{\theta\theta}(\theta_\infty)$ , which in turn can be determined from  $\Gamma_\theta$  as in (5.49). Apparently,  $V_{\gamma\gamma}$  is a frequency-weighted version of  $V_{\theta\theta}$ . In a practical situation  $\theta_\infty$  is unknown, and replaced by an initial parameter estimate  $\theta_{\text{init}}$ .

Now that we can compute  $V_{\gamma\gamma}$  from the parametrization and an initial model, the presence of  $\Phi_u(\omega, \xi)$  can be exploited in optimal input design. Since  $V_{\theta\theta}$  depends on  $\Phi_u$ , so does  $V_{\gamma\gamma}$ , and it can be written as  $V_{\gamma\gamma}(\theta_{\text{init}}, \xi)$  where  $\xi$  is again the input protocol that determines the input signal  $u$ .

The optimal protocol  $\xi^*$  is obtained as in (5.1):

$$\xi^* = \arg \text{opt}_\xi V_{\text{ED}}(W, V_{\gamma\gamma}(\theta_{\text{init}}, \xi)) \quad (5.50)$$

where  $V_{ED}$  is one of the scalar functions (5.18)–(5.20), discussed in Section 5.2, and where the relative importance for each frequency is determined by a diagonal weighting matrix  $W$

$$W = \text{diag}(w(\omega_1), w(\omega_1), w(\omega_2), w(\omega_2), \dots, w(\omega_m), w(\omega_m)) \quad (5.51)$$

with  $w(\omega)$  the weight per frequency. If  $\omega_j = 0$  for some  $j$  (hence for odd  $d$ ), only one weighting coefficient is added.

The input design problem then becomes, for the different functions  $V_{ED}$ :

$$\xi^* = \arg \max_{\xi} \det\{W'V_{\gamma\gamma}(\theta_{\text{init}}, \xi)W\} \quad (5.52a)$$

$$h(\xi) \leq 0$$

$$\xi^* = \arg \max_{\xi} \lambda_{\min}\{W'V_{\gamma\gamma}(\theta_{\text{init}}, \xi)W\} \quad (5.52b)$$

$$h(\xi) \leq 0$$

$$\xi^* = \arg \min_{\xi} \text{tr}\{W'V_{\gamma\gamma}^{-1}(\theta_{\text{init}}, \xi)W\}. \quad (5.52c)$$

$$h(\xi) \leq 0$$

Some examples in the following sections show how this procedure can be used to determine an optimal input protocol for open-loop identification. The extension toward closed-loop identification is given in Section 5.6. The choice of the weighting matrix  $W$  is discussed in Section 5.7.

### 5.5.2 FIR input design example

The first example considers the identification of an FIR model with two parameters, with a sinusoid input signal, a filtered white noise input and a GBN input.

The function to be maximized is the determinant of  $V_{\gamma\gamma}$ , and there is an input power constraint. The optimal input will then satisfy this constraint, so  $h(\xi^*) = 0$  (Gevers and Ljung, 1986).

The solution in these examples is found analytically. In general, more parameters and more complex input signals are used. Then the solution can be calculated numerically (Schinkel, 1994).

Suppose that the two parameters of the following FIR model are estimated.

$$G(z, \theta) = b_1 z^{-1} + b_2 z^{-2} \quad (5.53)$$

with

$$\theta = (b_1 \ b_2)'$$

Following the definitions of the previous section, we see that

$$\begin{aligned}\Gamma &= \begin{pmatrix} b_1 \cos \omega + b_2 \cos 2\omega \\ -b_1 \sin \omega - b_2 \sin 2\omega \end{pmatrix} \\ \gamma &= \begin{pmatrix} b_1 \cos \omega_1 + b_2 \cos 2\omega_1 \\ -b_1 \sin \omega_1 - b_2 \sin 2\omega_1 \end{pmatrix} \\ \Gamma'_\theta \Gamma_\theta &= \begin{bmatrix} 1 & \cos \omega \\ \cos \omega & 1 \end{bmatrix} \\ \gamma_\theta &= \begin{bmatrix} \cos \omega_1 & \cos 2\omega_1 \\ -\sin \omega_1 & -\sin 2\omega_1 \end{bmatrix}\end{aligned}$$

for some  $\omega_1 \in (0, \pi)$ .

Since only one  $\omega_1$  is considered, the weighting matrix  $W$  has no influence, so  $W = I_2$ , and we have

$$\det V_{\gamma\gamma} = \frac{\det V_{\theta\theta}}{(\det \gamma_\theta)^2} = \frac{1}{\sin^2 \omega_1} \det V_{\theta\theta}.$$

Maximizing  $\det V_{\gamma\gamma}$  is thus independent of the choice of  $\omega_1$ .

The Hessian  $V_{\theta\theta}$  is given by (5.49) as

$$V_{\theta\theta} = \frac{1}{\pi} \int_{-\pi}^{\pi} \begin{bmatrix} 1 & \cos \omega \\ \cos \omega & 1 \end{bmatrix} \Phi_u(\omega, \xi) d\omega \quad (5.54)$$

for any input signal  $u$ , and  $L = H = 1$ .

The input power constraint is formulated as

$$\frac{1}{2\pi} \int_{-\pi}^{\pi} \Phi_u(\omega) d\omega \leq P_m. \quad (5.55)$$

The optimal input protocol  $\xi^*$  is determined for a sinusoid input, for filtered white noise and for GBN.



**Sinusoid input**

The input signal is

$$u_t = A \sin \omega_u t \quad (5.56)$$

and the associated protocol is

$$\xi = (A \ \omega_u)'. \quad (5.57)$$

Consequently, the input spectrum is

$$\Phi_u(\omega) = \frac{\pi A^2}{2} \delta(\omega \pm \omega_u) \quad (5.58)$$

and the input power constraint results in

$$\frac{1}{2\pi} \int_{-\pi}^{\pi} \frac{\pi A^2}{2} \delta(\omega \pm \omega_u) d\omega = \frac{A^2}{2} = P_m$$

and hence

$$A^* = \sqrt{2P_m}. \quad (5.59)$$

The Hessian  $V_{\theta\theta}$  is, according to (5.54) and (5.58),

$$V_{\theta\theta} = A^2 \begin{bmatrix} 1 & \cos \omega_u \\ \cos \omega_u & 1 \end{bmatrix}$$

and hence

$$\det V_{\theta\theta} = A^4 \sin^2 \omega_u.$$

The optimization problem then becomes

$$\xi^* = \arg \max_{\substack{\xi \\ A = \sqrt{2P_m}}} \frac{A^4 \sin^2 \omega_u}{\sin^2 \omega_1}$$

with  $A^*$  given by (5.59), and  $\omega_u^*$  determined by the unconstrained problem

$$\omega_u^* = \arg \max_{\omega_u} \frac{4P_m^2 \sin^2 \omega_u}{\sin^2 \omega_1}$$

The solution is then

$$\omega_u^* = \pi/2$$

which is indeed independent of  $\omega_1$ !

To summarize, the optimal input protocol is given by

$$\xi^* = ( A^* \ \omega_u^* )' = ( \sqrt{2P_m} \ \pi/2 )' \quad (5.60)$$

which is independent of  $\omega_1$ . This implies that the variance of the frequency function of this FIR model (5.53) is minimal over the entire frequency range, if  $\omega_u = \pi/2$ .

### ***Filtered white noise input***

Let the input be a white noise sequence  $e_t$ , filtered through a first order MA filter

$$u_t = K(1 + d_1 q^{-1})e_t \quad (5.61)$$

where  $\text{var}(e_t^2) = 1$ , and

$$\xi = ( K \ d_1 ). \quad (5.62)$$

Then

$$\Phi_u(\omega) = K^2(1 + d_1^2 + 2d_1 \cos \omega). \quad (5.63)$$

The power constraint (5.55) results in

$$K^2(1 + d_1^2) \leq P_m \quad \Rightarrow \quad K^2 = \frac{P_m}{1 + d_1^2}. \quad (5.64)$$

Hence  $K$  is chosen to maximize the input power.

The Hessian  $V_{\theta\theta}$  can be obtained by combining (5.54) and (5.63) as

$$V_{\theta\theta} = 2K^2 \begin{bmatrix} 1 + d_1^2 & d_1 \\ d_1 & 1 + d_1^2 \end{bmatrix}$$

and hence

$$\det V_{\theta\theta} = 4K^4(1 + d_1^2 + d_1^4).$$

The constrained optimization problem can be rewritten as an unconstrained problem by inserting (5.64), which yields

$$d_1^* = \arg \max_{d_1} \frac{1}{\sin^2 \omega_1} \frac{4P_m^2(1 + d_1^2 + d_1^4)}{1 + 2d_1^2 + d_1^4}$$

of which the solution is

$$d_1^* = 0$$

Hence the optimal protocol is

$$\xi^* = (K^* \ d_1^*)' = (\sqrt{P_m} \ 0)' \quad (5.65)$$

which is again independent of  $\omega_1$ .

This optimal protocol results in a white noise  $u$ , with the amplitude multiplied by  $K$ .

### **Generalized Binary Noise input**

The frequency-domain behavior of GBN is determined by the amplitude  $A$ , the nonswitching probability  $p$ , and the basic switching time  $T_b$ . Normalizing  $T_b = 1$ , the input protocol is

$$\xi = (A \ p)'. \quad (5.66)$$

The spectrum is given by (5.26). Inserting this into (5.54),  $V_{\theta\theta}$  can be calculated as

$$V_{\theta\theta} = 2A^2 \begin{bmatrix} 1 & q \\ q & 1 \end{bmatrix}.$$

To satisfy the input power constraint, we have

$$A^* = \sqrt{P_m}$$

and  $q^*$  is obtained as

$$q^* = \arg \max_q \frac{4P_m^2(1-q^2)}{\sin^2 \omega_1} = 0$$

and hence

$$p^* = 0.5.$$

The optimal GBN protocol is thus

$$\xi^* = (A^* \ p^*)' = (\sqrt{P_m} \ 0.5)'$$
 (5.67)

which results in a PRBS with amplitude  $\sqrt{P_m}$ , and is equivalent to the result (5.65).

### **Interpretation**

Both the optimal filtered white noise input signal and the optimal GBN input signal are white, with maximum possible amplitude. A multisine input signal results in a spectrum, symmetric around  $\omega = \pi/2$  (Schinkel, 1994). This is not as surprising as it seems. The implicit assumption is that  $S \in \mathcal{M}$ , and therefore, if an FIR model is estimated, the noise is assumed to be white. It is then straightforward to assume that the input spectrum should be flat as well.

The symmetry around  $\pi/2$  can be explained from the fact that  $V_{\theta\theta}$  (5.54) equals the covariance matrix of  $u_t$ :

$$V_{\theta\theta} = \begin{bmatrix} R_u(0) & R_u(1) \\ R_u(1) & R_u(0) \end{bmatrix}$$
 (5.68)

and, if more than two parameters are estimated, this matrix is extended with  $R_u(\tau)$  for larger  $\tau$ . Hence, maximizing the determinant of  $V_{\theta\theta}$  comes down to maximizing the determinant of the covariance matrix of  $u_t$ . This appears to be maximum for spectra, symmetrical around  $\omega = \pi/2$ .

### 5.5.3 OE input design example

The second example addresses the identification of a first order OE model, with a sinusoidal excitation signal and the determinant input design criterion.

Let the parameters of the following first order OE model be estimated.

$$G(z) = \frac{bz^{-1}}{1 + fz^{-1}}. \quad (5.69)$$

Then  $\Gamma$  is defined as

$$\Gamma(\omega) = \left( \begin{array}{cc} \frac{bf + b \cos \omega}{1 + f^2 + 2f \cos \omega} & \frac{-b \sin \omega}{1 + f^2 + 2f \cos \omega} \end{array} \right)'$$

from which we can compute  $\Gamma'_\theta \Gamma_\theta$  as

$$\Gamma'_\theta \Gamma_\theta = \left[ \begin{array}{cc} \frac{1}{1 + f^2 + 2f \cos \omega} & \frac{-bf - b \cos \omega}{(1 + f^2 + 2f \cos \omega)^2} \\ \frac{-bf - b \cos \omega}{(1 + f^2 + 2f \cos \omega)^2} & \frac{b^2}{(1 + f^2 + 2f \cos \omega)^2} \end{array} \right].$$

Again we work with the determinant of  $V_{\gamma\gamma}$ , which is given by

$$\det V_{\gamma\gamma} = \frac{1}{(\det \gamma_\theta)^2} \det V_{\theta\theta}(\xi).$$

From  $\Gamma(\omega)$  we can determine  $\gamma$  for some  $\omega_1$ , and the determinant of  $\gamma_\theta$  as

$$\det \gamma_\theta = \frac{-b \sin \omega_1}{(1 + f^2 + 2f \cos \omega_1)^2}.$$

To formulate the optimization problem, also the  $\xi$ -dependent determinant of  $V_{\theta\theta}$  must be calculated. This is done for a pure sinusoid input, which is given by

$$u_t = A \sin \omega_u t \quad (5.70)$$

with  $\xi = \left( \begin{array}{c} A \\ \omega_u \end{array} \right)'$ .

The amplitude  $A^*$  is again chosen such that the input power is maximized, and therefore

$$A^* = \sqrt{2P_m}. \quad (5.71)$$

Calculating  $\det V_{\gamma\gamma}$  yields

$$\det V_{\gamma\gamma} = A^4 \frac{(1 + f^2 + 2f \cos \omega_1)^4}{b^2 \sin^2 \omega_1} \frac{b^2 \sin^2 \omega_u}{(1 + f^2 + 2f \cos \omega_u)^4}. \quad (5.72)$$

The optimal  $A^*$  is given by (5.71), and  $\omega_u^*$  is found by maximizing (5.72).

Since the model is stable by assumption,  $f \in (-1, 1)$ . If  $f = 0$ , (5.72) is maximal for  $\omega_u^* = \pi/2$ . For all other  $f \in (-1, 1) \setminus \{0\}$ ,  $\omega_u^*$  is the solution of

$$\cos \omega_u^* = \frac{1 + f^2 \pm \sqrt{f^4 + 34f^2 + 1}}{4f}. \quad (5.73)$$

In Figure 5.4  $\omega_u^*$  is shown as a function of  $f$ .

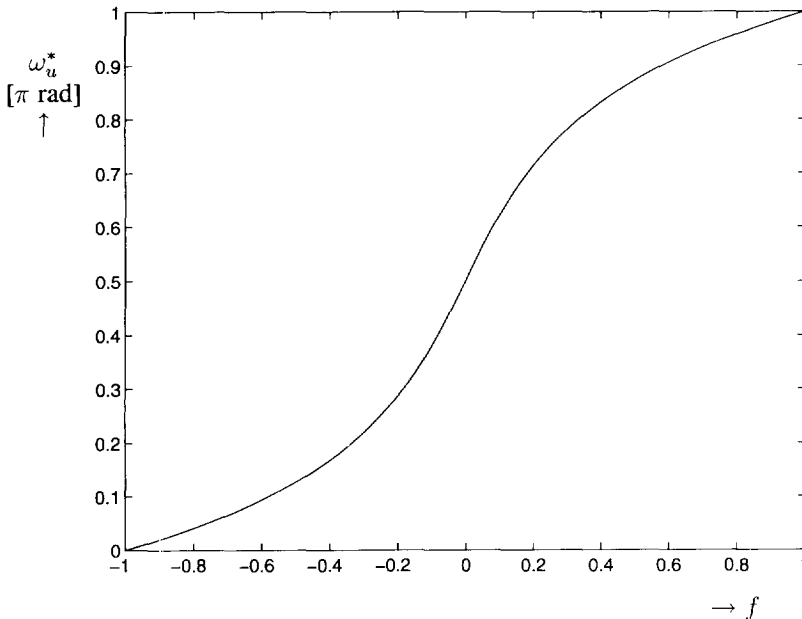

Figure 5.4. Optimal frequency  $\omega_u^*$  as a function of  $f$ , as in (5.73)

Hence the optimal frequency depends on the initial model parameter  $f$ . Note that it is implicitly assumed that  $\mathcal{S} \in \mathcal{M}$ , and hence that  $f = f_0$ , the true value of  $f$ .

## 5.6 Closed-loop frequency-domain design

The same procedure, as that reported in the previous section for open-loop identification, can be used to design an input for closed-loop identification. If GI or TS is used for closed-loop identification, (5.46) still applies, although  $\theta$  now contains  $d + d_S$  parameters of  $G$  and  $S$ , respectively, where  $G$  and  $S$  can have a joint parametrization. The parameter  $\gamma$  contains points of the frequency function of both  $G$  and  $S$ , and  $\gamma_\theta$  depends on the parametrization of these, and the specific  $\omega_j$  chosen in  $\gamma$ . Moreover, the Hessian  $V_{\theta\theta}$  is different for closed-loop identification.

In this section, a general expression for  $V_{\theta\theta}$  is derived, and the implications are shown for some specific choices of closed-loop identification methods.

For GI (Section 2.5), the asymptotic SISO identification criterion is given by

$$V = \frac{1}{2\pi} \int_{-\pi}^{\pi} \{ |G_0 S_0 - GS|^2 + |S_0 - S|^2 \} \Phi_r + \{ 1 + |C_b|^2 \} |S_0|^2 \Phi_v d\omega \quad (5.74)$$

where the dependence of  $e^{i\omega}$  is omitted for the sake of readability.

We define the real-valued 2-vectors  $\Gamma$ ,  $\Psi$  and  $\Xi$  as

$$\Gamma = \begin{pmatrix} \text{Re}\{G\} \\ \text{Im}\{G\} \end{pmatrix} \quad \Psi = \begin{pmatrix} \text{Re}\{S\} \\ \text{Im}\{S\} \end{pmatrix} \quad \Xi = \begin{pmatrix} \text{Re}\{GS\} \\ \text{Im}\{GS\} \end{pmatrix} \quad (5.75)$$

and likewise for  $\Gamma_0$ ,  $\Psi_0$  and  $\Xi_0$ . Hence

$$\Xi = \begin{pmatrix} \Gamma_1 \Psi_1 - \Gamma_2 \Psi_2 \\ \Gamma_1 \Psi_2 + \Gamma_2 \Psi_1 \end{pmatrix} = \begin{bmatrix} \Gamma_1 & -\Gamma_2 \\ \Gamma_2 & \Gamma_1 \end{bmatrix} \Psi = \begin{bmatrix} \Psi_1 & -\Psi_2 \\ \Psi_2 & \Psi_1 \end{bmatrix} \Gamma \quad (5.76)$$

and (5.74) can be rewritten as

$$V = \frac{1}{2\pi} \int_{-\pi}^{\pi} \{ |\Xi_0 - \Xi|^2 + |\Psi_0 - \Psi|^2 \} \Phi_r + \{ 1 + |C_b|^2 \} |\Psi_0|^2 \Phi_v d\omega. \quad (5.77)$$

Now  $\gamma$  is a  $(d + d_S)$ -vector, containing  $d$  values of  $\Gamma(\omega)$  and  $d_S$  values of  $\Psi(\omega)$  for different frequencies. Again  $G(1)$  and  $S(1)$  can be included to make the size of  $\gamma$  equal to the size of  $\theta$ .

A similar derivation as in the open-loop case yields the following expression for the Hessian  $V_{\theta\theta}$ .

$$V_{\theta\theta}(\theta_\infty) = \frac{1}{\pi} \int_{-\pi}^{\pi} \{ \Xi'_\theta \Xi_\theta + \Psi'_\theta \Psi_\theta \} \Phi_r d\omega \quad (5.78)$$

with

$$\Xi_{\theta} = \Xi_{\Psi}\Psi_{\theta} + \Xi_{\Gamma}\Gamma_{\theta} \quad (5.79)$$

and, from (5.76),

$$\Xi_{\Psi} = \begin{bmatrix} \Gamma_1 & -\Gamma_2 \\ \Gamma_2 & \Gamma_1 \end{bmatrix}, \quad \Xi_{\Gamma} = \begin{bmatrix} \Psi_1 & -\Psi_2 \\ \Psi_2 & \Psi_1 \end{bmatrix}. \quad (5.80)$$

Hence

$$\Xi'_{\Psi}\Xi_{\Psi} = |\Gamma|^2 I_2, \quad \Xi'_{\Gamma}\Xi_{\Gamma} = |\Psi|^2 I_2. \quad (5.81)$$

For input design  $\theta_{\infty}$  is replaced by the initial estimate  $\theta_{\text{init}}$ . For each parametrization of  $G$  and  $S$  the above expressions can then be calculated, and the resulting  $V_{\theta\theta}(\theta_{\text{init}})$  can be used to determine an optimal input.

If  $G$  and  $S$  are parametrized independently,  $\theta$  can be decomposed as

$$\theta = (\alpha' \beta')' \quad (5.82)$$

with  $G$  parametrized by  $\alpha \in \mathbb{R}^n$  and  $S$  parametrized by  $\beta \in \mathbb{R}^m$ . In that case,  $V_{\theta\theta}(\theta_{\infty})$  has an interesting form for different identification methods:

1. for TS, for which  $\hat{\alpha}$  and  $\hat{\beta}$  are identified independently,
2. for GI with independently parametrized  $G$  and  $S$ ,
3. and for DI, which does not take into account the feedback ( $\beta$  nonexistent).

### **Two-Step method**

In the second step of the Two-Step method (Section 2.4.5), only  $G(\hat{\alpha})$  is estimated. Consequently,

$$\Psi_{\alpha} = \mathbf{0}_{2 \times r}. \quad (5.83)$$



and  $V_{\theta\theta}$  in (5.78) becomes  $V_{\alpha\alpha}$

$$V_{\alpha\alpha}(\theta_\infty) = \frac{1}{\pi} \int_{-\pi}^{\pi} \Gamma'_\alpha \Gamma_\alpha |\Psi|^2 \Phi_r d\omega. \quad (5.84)$$

Since  $|\Psi|^2 \Phi_r = |S(\hat{\beta})|^2 \Phi_r = \Phi_{u^r}$ , this is similar to (5.49) with  $\Phi_{u^r}$  instead of  $\Phi_u$ . Hence the input design procedure for TS comes down to open-loop design of the noise-free input  $u^r$ . The optimal external excitation signal  $r_t^*$  is determined by filtering  $u^r$  through  $1/S(\hat{\beta})$ .

### Generalized Identification method

If  $G$  and  $S$  are independently parametrized, we have

$$\Psi_\theta = \begin{bmatrix} \Psi_\alpha & \Psi_\beta \end{bmatrix} = \begin{bmatrix} 0_{2 \times n} & \Psi_\beta \end{bmatrix} \quad (5.85a)$$

$$\Gamma_\theta = \begin{bmatrix} \Gamma_\alpha & \Gamma_\beta \end{bmatrix} = \begin{bmatrix} \Gamma_\alpha & 0_{2 \times m} \end{bmatrix} \quad (5.85b)$$

and  $V_{\theta\theta}$  takes on a block-partitioned structure:

$$V_{\theta\theta}(\theta_\infty) = \frac{1}{\pi} \int_{-\pi}^{\pi} \begin{bmatrix} \Gamma'_\alpha \Gamma_\alpha |\Psi|^2 & \Gamma'_\alpha \Xi'_\Gamma \Xi_\Psi \Psi_\beta \\ \Psi'_\beta \Xi'_\Psi \Xi_\Gamma \Gamma_\alpha & \Psi'_\beta \Psi_\beta |\Gamma|^2 \end{bmatrix} \Phi_r d\omega. \quad (5.86)$$

This block-partitioned structure can be exploited if the determinant is used as the input design criterion.

Note in particular that if the variance of  $G(e^{i\omega}, \hat{\alpha})$  only is of importance, the GI expression (5.86) reduces to the TS expression (5.84).

### Direct Identification

In Direct Identification (Section 2.4.1) the feedback is neglected, and hence the noise plays an important role. The Hessian  $V_{\theta\theta}$  depends on the noise, which can be seen from the following derivation.

The asymptotic DI criterion can be written as

$$V_{DI, \infty} = \frac{1}{2\pi} \int_{-\pi}^{\pi} |\Gamma_0 - \Gamma|^2 |\Psi_0|^2 \Phi_r + |\bar{\Psi}|^2 |\Psi_0|^2 \Phi_v d\omega \quad (5.87)$$

with  $\Gamma$  and  $\Psi$  defined as in (5.75), and

$$\bar{\Psi} = \left( \operatorname{Re}\{S^{-1}\} \quad \operatorname{Im}\{S^{-1}\} \right)' \quad (5.88)$$

and

$$S(\theta) = \frac{1}{1 + C_b G(\theta)}. \quad (5.89)$$

From this expression, we can derive  $V_{\theta\theta}(\theta_\infty)$  in the same way as before. Making use of the fact that

$$\bar{\Psi}_\theta = \bar{\Psi}_\Gamma \Gamma_\theta \quad (5.90)$$

and that

$$\bar{\Psi}_\Gamma = \begin{bmatrix} \operatorname{Re}\{C_b\} & -\operatorname{Im}\{C_b\} \\ \operatorname{Im}\{C_b\} & \operatorname{Re}\{C_b\} \end{bmatrix} \quad (5.91)$$

and replacing  $\Psi_0$  by the initial estimate  $\Psi(\theta_{\text{init}})$ , this results in

$$V_{\theta\theta}(\theta_{\text{init}}) = \frac{1}{\pi} \int_{-\pi}^{\pi} \Gamma_\theta' \Gamma_\theta \left\{ |\Psi(\theta_{\text{init}})|^2 \Phi_r + |C_b|^2 |\Psi(\theta_{\text{init}})|^2 \Phi_v \right\} d\omega \quad (5.92)$$

Hence we have to optimize over the *closed-loop* input spectrum

$$\Phi_u = |\Psi(\theta_{\text{init}})|^2 \Phi_r + |C_b|^2 |\Psi(\theta_{\text{init}})|^2 \Phi_v \quad (5.93)$$

and calculate  $\Phi_r^*$  from this.

Apart from the question of whether a feasible solution  $\Phi_r^*$  can be found, input design for Direct Identification appears to depend on knowledge of the noise characteristics. Hence, this can only be done if the noise characteristics are known.

To summarize, an expression has been found for  $V_{\theta\theta}(\theta_\infty)$ , with which it is possible to do optimal input design for closed-loop identification. The particular form depends on the closed-loop identification procedure that is going to be used, and for TS, GI and DI these particular forms have been derived.

## 5.7 Choice of weighting functions

The optimal input design procedures, proposed in this chapter, can be written as (5.1) and (5.52). Typical cost functions are the determinant, the smallest eigenvalue or the trace of a weighted Hessian  $V_{xx}$ , where  $x$  is either  $\theta$  or  $\gamma$ , as discussed in Section 5.2.

In this section we discuss how to choose the weights for these cost functions.

**Determinant**

The optimal input design problem is

$$\xi^* = \arg \max_{\substack{\xi \\ h(\xi) \leq 0}} \det W' V_{xx}(\theta_{\text{init}}, \xi) W. \quad (5.94)$$

Since  $\det W' V_{xx} W = \det W' \det V_{xx} \det W$ , the choice of  $W$  has no influence on the minimizing argument  $\xi^*$ . In other words,  $W$  plays no role, and it can be chosen arbitrarily (as long as  $\det W \neq 0$ ).

Note in particular that

$$\det V_{\gamma\gamma} = \det \gamma_{\theta}^{-T} \det V_{\theta\theta} \det \gamma_{\theta}^{-1} = \frac{\det V_{\theta\theta}}{\det(\gamma_{\theta})^2} \quad (5.95)$$

and hence the specific  $\omega_j$ 's in  $\gamma$  have no influence on  $\xi^*$  either. Consequently, the same optimal protocol is found by minimizing  $\det V_{\gamma\gamma}$  as by minimizing  $\det V_{\theta\theta}$ .

**Smallest eigenvalue**

The optimal input design problem is

$$\xi^* = \arg \max_{\substack{\xi \\ h(\xi) \leq 0}} \lambda_{\min}\{W' V_{xx}(\theta_{\text{init}}, \xi) W\}. \quad (5.96)$$

and  $W$  clearly has influence on  $\xi^*$ .

If  $V_{\theta\theta}$  is the Hessian that is used,  $W$  amplifies the importance of certain parameters. Therefore, for the parameters that are relatively important,  $W$  must be large.

If  $V_{\gamma\gamma}$  is used,  $W^{-1}$  can be seen to weigh  $\gamma_{\theta}$ , which is the sensitivity of  $\gamma$  with respect to  $\theta$ . Hence, by giving an element of  $\gamma_{\theta}$  a small weight, the sensitivity for that same frequency becomes larger in the final result. Therefore,  $W^{-1}$  should be small, and  $W$  large, for the frequencies that are considered specifically important.

**Trace**

The optimal input design problem is

$$\xi^* = \arg \min_{\xi} \text{tr}\{W'V_{xx}^{-1}(\theta_{\text{init}}, \xi)W\} \quad (5.97)$$

$$h(\xi) \leq 0$$

and the influence of  $W$  is clear.

By increasing  $W$  for a specific parameter (or point of the frequency function), it becomes more important in the overall result. Therefore  $W$  should be large for relatively important parameters (or points of the frequency function).

In the latter two cases it is up to the modeler to decide on the relative importance of parameters or points of the frequency function. It is straightforward to state that it should depend on the subsequent control design step (e.g., small variance around the future crossover frequency), but how to determine  $W$  remains an open question.

## 5.8 Closed-loop excitation considerations

Suppose that an excitation spectrum  $\Phi_r(\omega)$  has been designed. It should now be decided where to inject the excitation signal in the loop. Recalling the closed-loop configuration, shown in Figure 1.2, there are three possible choices:  $r_{1,t}$ ,  $r_{2,t}$ , or a combination of these. In all cases we have

$$C_f(e^{i\omega})\Phi_{r,1}(\omega)C_f'(e^{-i\omega}) + \Phi_{r,2}(\omega) = \Phi_r(\omega) \quad (5.98)$$

with  $\Phi_{r,1}$  and  $\Phi_{r,2}$  the free design parameters.

Apparently, the objective is always to generate the excitation signals  $r_1$  and  $r_2$ , such that  $\Phi_r(\omega)$  has the required characteristics.

There are three successive questions, of which the answers determine where to inject the excitation signal. They are, respectively

1. Is it possible to inject at both places, or does the process impose restrictions on the location?
2. Does the location of the excitation signal influence the identification results?
3. Is it possible to generate the desired excitation spectrum at both locations?

**Ad 1.** If the physical properties of the process or the instrumentation do not allow the injection of an excitation signal at one of the two locations, the other should be chosen. Hence, in this case, the limitations of the process determine where to inject the input signal. If there are no constraints in this regard, the second question has to be addressed.

**Ad 2.** The properties of the identification results that could be influenced by the location of the input signal are the bias and the variance of the estimates.

Assuming that  $\Phi_r$  can be generated by injecting both at  $r_1$  and at  $r_2$ , the location of the signal does not influence the bias. This can be seen from the asymptotic expressions given in Chapter 2, which depend on  $\Phi_r$ , no matter whether it is generated by  $r_1$  or  $r_2$ .

To determine the effect of the location of the excitation signal on the variance of the estimates, we use the expressions for the variance of  $\hat{G}(e^{i\omega})$  that have been derived by Yuan and Ljung (1984), Ljung (1985) and Zhu (1990). They are valid for open-loop identification, under the assumption that  $S \in \mathcal{M}$ , the model order  $d$  tends to  $\infty$  as  $N \rightarrow \infty$ , and  $d^2/N \rightarrow 0$ . The latter assumptions are needed to achieve uncorrelatedness between the frequency function estimates for different frequencies. Although these assumptions are quite restrictive, it has been shown by Ljung (1987) that, for finite  $d$ , the expressions are approximately valid.

For multivariable systems, if  $S \in \mathcal{M}$ , the asymptotic variance expression is

$$\text{var}\{\hat{G}(e^{i\omega})\} \approx \frac{d}{N} \Phi_u^{-1}(\omega) \otimes \Phi'_v(\omega) \quad (5.99)$$

with  $\Phi_u$  the spectrum of the open-loop input,  $\Phi_v$  the spectrum of the additive output noise, and  $\otimes$  the Kronecker product (see Appendix A).

Under the same assumptions, variance expressions for  $\hat{G}$  can be derived for the closed-loop case. Ljung (1993) shows that for Direct Identification the variance expression of an SISO estimate becomes

$$\text{var}\{\hat{G}(e^{i\omega})\} \approx \frac{d}{N} \frac{\Phi_v(\omega)}{|S_0|^2 \Phi_r(\omega)}. \quad (5.100)$$

This expression shows that the variance does not depend on the location of the excitation signal, as long as the same  $\Phi_r$  is realized.

What can be seen from (5.100), however, is that the variance of  $\hat{G}$  for DC ( $\omega = 0$ ), tends to infinity if there is an integrator in the loop; for, in that case,  $S_0(1) = 0$ , and (5.100) becomes infinitely large.

For the Generalized Identification method, the multivariable expression can be derived as follows. Defining  $z_t$  as in (2.61), the closed-loop behavior is described by (cf. (2.42))

$$z_t = \begin{bmatrix} G_0 \\ I_m \end{bmatrix} S_0^{(i)} r_t + \begin{bmatrix} I_p \\ -C_b \end{bmatrix} S_0^{(o)} v_t. \quad (5.101)$$

For the identification of  $\hat{G}$  and  $\hat{S}^{(i)}$ , there is an open-loop situation, and (5.99) applies. The variance of the estimates is given by

$$\text{var} \begin{bmatrix} \widehat{GS}(e^{i\omega}) \\ \hat{S}(e^{i\omega}) \end{bmatrix} \approx \frac{d}{N} \Phi_r^{-1}(\omega) \otimes \begin{bmatrix} S_0^{(o)} \Phi_v [S_0^{(o)}]^* & -S_0^{(o)} \Phi_v [S_0^{(o)}]^* C_b^* \\ -C_b S_0^{(o)} \Phi_v [S_0^{(o)}]^* & C_b S_0^{(o)} \Phi_v [S_0^{(o)}]^* C_b^* \end{bmatrix}' \quad (5.102)$$

with

$$\Phi_v = H_0 \Phi_e H_0^* \quad (5.103)$$

under the assumption that  $\hat{S}$  and  $\widehat{GS}$  are independently parametrized models.

From (5.102) we can determine the influence of the location of the excitation signal on the variance of the estimates. In the analysis of this expression, we assume that  $G_0$  is SISO for the sake of readability. In that case, the variance of  $\hat{S}$  is given by

$$\text{var}\{\hat{S}(e^{i\omega})\} \approx \frac{d}{N} \frac{|C_b S_0|^2 \Phi_v}{\Phi_r}. \quad (5.104)$$

In GI,  $\hat{G}$  is computed using  $\hat{S}$ , and the variance of  $\hat{G}$  can be defined as the variance of  $\hat{G}$ , while  $\hat{S}$  is given. This becomes

$$\text{var}\{\hat{G}(e^{i\omega})\} \approx \frac{d}{N} \frac{|S_0|^2 \Phi_v}{|\hat{S}|^2 \Phi_r}. \quad (5.105)$$

Again we see that the variance of  $\hat{G}$  does not depend on the location of the excitation signal, as long as the desired  $\Phi_r$  is realized.

However, another observation is that, for DC, the variance of  $\hat{G}$  does not tend to infinity if there is an integrator in the loop, since  $S_0$  in the numerator is zero at DC.

Comparing (5.105) and (5.100), we see that this is an additional motivation for using GI instead of DI.

To summarize, the location of the excitation signal does not influence the identification result, as long as the desired  $\Phi_r$  can be realized. Consequently, to determine where to place the excitation signal, the third question has to be answered.

The analysis did show, however, that the difference in variance at DC shows a preference for GI over DI.

**Ad 3.** If the process to be identified does not impose limitations with respect to the location of the excitation signal, the only criterion on which to decide on this location is the ease of generation of  $r_t$ : is it easier to generate it through  $r_1$  or through  $r_2$ ? Using a combination of  $r_1$  and  $r_2$  is possible, but it does not give any advantages over using only one of them, and therefore we restrict attention to selecting only one.

There are several rules which can help to determine the location

- If  $\Phi_r$  can be generated directly, it is more straightforward to use  $r_2$ .
- If  $C_f$  is unknown,  $r_1$  cannot be computed, and  $r_2$  should be used.
- If  $\Phi_r$  contains an integrator, and so does  $C_f$  (e.g., if the controller is of the PID type), it is more straightforward to use  $r_1$  for ease of computation.

Finally, it should be realized that a process operator might be inclined to refuse injection of an excitation signal at  $r_1$ , since, in general, this is the set point of the quality controller. He might be more willing to inject it at  $r_2$ , since “the controller will attenuate the effects”. Although, of course, exactly the same effect can be obtained from  $r_1$  and  $r_2$ , this psychological threshold might be the most important reason to choose to excite the loop through  $r_2$ .

## 5.9 Model validation

If a model has been obtained from (closed-loop) data, its validity should be evaluated. This procedure of model evaluation is called *model validation*. It consists of comparing model properties (e.g., simulated outputs) with measured plant properties (e.g., measured outputs). This is usually done with a new data set, different from the data set with which the model is identified. This eliminates the possibility that the model is good only for the specific noise realization, present in the data set used for identification. Therefore, model validation is often termed *cross-validation*. The data set with which the model is identified then is the identification set, and the data set that is used for model validation is the validation set.

Since it is impossible to *prove* the correctness of a model, without knowing the real plant, we can only *invalidate* a model (Sargent, 1988; Smith, 1989). That is, we try our best to prove that the model is *not* correct, and if we do not succeed, we accept the model as valid.

We distinguish between *objective* and *subjective* model invalidation techniques (Schinkel, 1993). An objective method is based on mathematical analysis, and it uses a certain

threshold to decide whether or not to reject the model. A subjective method relies on the experience and the interpretation of the modeler to make this decision. In general, a combination of both should be used for model validation.

Objective invalidation techniques are based on the analysis of residuals. Taking the viewpoint that a model should predict the future behavior of the plant, the difference between the predictions and the plant output in a validation set, which is the *residual*, is a measure for the invalidity of the model.

A well-known method is *correlation analysis*. The whiteness of the residuals and the lack of correlation between the process input and the residual are investigated. They have the following interpretation. If there is no correlation between input and residuals, all information present in the output signal, that stems from the input signal, has been explained by the input/output model, and no further improvement can be expected. If in addition the residuals are white, the noise model is a good description of the real noise process. Both properties of the residuals can be tested using hypothesis tests with a certain confidence level (Ljung, 1987; Söderström and Stoica, 1989).

A second objective invalidation technique is the *distortion method* (Butterfield and Thomas, 1986). This method can only be used when a noise model is estimated. A *distortion vector* is defined that contains the maximum variation of the parameter vector, needed to get the prediction error to zero. This is compared to a maximum allowed distortion, and if it is larger the model is rejected.

Of course, a subjective element can be built into these objective invalidation techniques by further analyzing the residuals. For example, the spectrum of the residual might be small in the region of interest, and larger where it does no harm. In that case a model can be accepted, although it is invalidated by correlation analysis.

Among the subjective invalidation methods, anything that the modeler can think of is possible (Schinkel, 1993). A general method is to compare the time sequences of the measured and the simulated model output to see if there is a big difference. Most of these methods are based on graphical interpretation of measured and predicted data.

For the iterative scheme of closed-loop identification and control design, described in Chapter 4, the invalidation techniques already mentioned can be used. The ultimate model validation test is the implementation of the new controller. However, this is an *a posteriori* model evaluation, and the validation step should also be done *before* the controller is implemented. This can be done by exploiting the criterion C2 in Figure 4.1. Since the model/controller pair is evaluated by C2 in the sense of improved control performance or tightened upper bound, it can be decided here whether or not to reject the model. Thus the validation is done before the controller is implemented.

This approach to model validation is clearly subjective.



## 5.10 Conclusions

In this chapter two practical aspects of (closed-loop) identification have been discussed. First, attention has been focused on the design of optimal input signals. Optimality of an input signal was defined as yielding a small variance of the model. Second, model validation has been discussed.

The relationship between the variance of the estimated parameters and the Hessian of the identification criterion has been investigated. The existence of such a relationship is the reason for the use of scalar functions of the Hessian, such as the determinant, the trace or the smallest eigenvalue, for optimal input design. The dependence of the Hessian on the input signal is then exploited in a constrained optimization problem. The geometric interpretation of the results in terms of minimization of the uncertainty intervals is quite illustrative. It should be noted, however, that the expressions derived in Section 5.2 are only valid in the neighborhood of  $\theta_\infty$ .

Two new input design methods have been proposed that are based on this principle. The first uses the Hessian with respect to the estimated parameters,  $V_{\theta\theta}$ . The variance of the parameters can thus be reduced, and redistributed over the parameters according to their relative importance.

Since the variance of the frequency function for different frequencies is more related to control performance, the second method uses the Hessian with respect to the frequency function,  $V_{\gamma\gamma}$ . The variance of the estimated frequency response can be reduced for different frequencies, and it can be redistributed over the frequency range, in accordance with the modeler's desire.

The relationship between both Hessians appears to be a frequency weighting that depends on the parametrization.

The frequency-domain input design method has been developed for both open-loop and closed-loop identification. Examples illustrate the use of these procedures.

The weighting matrices  $W$  in the optimal input design problems increase the relative importance of a specific parameter in the parameter variance case, or of a value of the frequency function in the frequency function variance case. The entries of  $W$  should be large for relatively important parameters. If the determinant of the Hessian is the function to be minimized, the weighting matrix has no influence, and the same optimal protocol is obtained from maximizing the determinant of  $V_{\theta\theta}$  and  $V_{\gamma\gamma}$ .

It is up to the modeler to decide which parameters are relatively important, and up to the systems and control community to provide him with tools for doing this.

The choice of location of the excitation signal in the loop was considered in Section 5.8. Three questions were posed, the answers of which determine where to locate the excitation signal.

First of all, the process might pose physical restrictions on the location. If this is not the case, the effect of the location of the excitation signal on the identification result can be considered. Analysis has shown that neither the bias, nor the variance are influenced by the location of the excitation signal, so to determine where to excite the loop, practical considerations, such as the ease of implementation and the recommendation of the process operator, are generally decisive.

Finally, model validation has been discussed. In general, it is advisable to use both objective and subjective invalidation techniques. The ultimate validation of closed-loop identification results should be based on the designed controller, before it is implemented.

## Chapter 6

---

# *Distillation column experiment*

## **6.1** *Introduction*

In the previous chapters, theory and algorithms have been developed in the area of closed-loop identification, model structure selection, on-line identification, iterative schemes for identification and controller design, input design and model validation. The developments have been supported by simulation results. To analyze the benefits in a practical application, an experiment with a real process must be carried out.

The experiment should fulfill a number of conditions.

To verify the use of closed-loop identification, and the conclusions drawn in Chapter 2, the experiment should be conducted in a situation where most items of Assumption 2.3 are justified. This implies that a multivariable process must be operating according to the scheme, shown in Figure 2.2, and that the assumptions regarding stability, linearity and stationarity are valid. The measurements must be available off line. The lattice algorithms can be tested on this data as well, but they are suited for SISO processes only.

To investigate the influence of identification filters on the designed controller and on the achieved performance, it should be possible to conduct a number of experiments. A performance measure should be defined, and this should be evaluated in an iterative scheme of identification and controller design. The assumption is then that the performance can be enhanced by improving the model.

The input design procedure presented in Chapter 5 can be evaluated by conducting several experiments as well. It must be possible to compare the variance of the models, obtained with different input protocols. The assumption that  $\mathcal{S} \in \mathcal{M}$  is a complicating factor, since this situation will never occur in practice.

To fulfill all these conditions, ideally a pilot plant or laboratory setup should be available, with which it is possible to control the influence of external disturbances. Several experiments can then be carried out under similar external conditions, thus revealing the effect of different choices of design variables.

However, in an early stage of the research project (maybe too early) we have selected an industrial process, namely a distillation column at the ESSO refinery in Rotterdam. In view of the limited time and availability of this installation, only one experiment could be carried out. Hence it was not possible to complete an iteration, and the effect of different choices of input signal and identification filters on the resulting achieved performance could not be investigated. Therefore we are forced to restrict our attention in this chapter to comparing the different closed-loop identification methods in view of the resulting models.

In the next section a description of the process is given, both in physical and control-oriented terms. The purpose of the research is stated, and attention is paid to the specific constraints that this process imposes on the identification experiment.

Then, in Section 6.3, the experiment design problem is considered. The variables used as inputs and outputs, the type of external excitation signal used, and the sampling times chosen, are discussed.

In Section 6.4, the results are given of applying DI, TS, GI and spectral analysis to the data. The models are compared both in the time and in the frequency domain, and an analysis is made of how a future experiment should be designed such that the resulting models are better.

Some concluding remarks are made in Section 6.5.

## 6.2 Process description

The subject of our study is a two-product distillation column. In this section we briefly describe the working principles of this plant and the control configuration. For more information on distillation columns and possible control schemes, we refer to, for example, Nisenfeld and Seeman (1981) and Shinsky (1984).

A two-product distillation column is used to separate two components in a liquid. The separation is based on a difference between the *vapor pressures* of the two components. The vapor pressure of a pure liquid is defined as the pressure for which the liquid is in equilibrium with its vapor for a given temperature, where equilibrium is defined as a state in which there is no driving force for change. The vapor pressure of a liquid is a function of its temperature.

Vapor pressure is closely related to boiling point. The vapor pressure is the pressure at which a pure liquid will boil at a given temperature. If the temperature increases, so will the vapor pressure, to reach equilibrium again.

The vapor pressure of a two-component liquid is not constant, but depends on the concentration of each component. At a given temperature, the component with the higher vapor

pressure is more volatile than the other, because the pressure should be increased to reach equilibrium again. The higher the vapor pressure of a component, the higher will be its concentration in the vapor at equilibrium with the liquid. Hence, the component with the higher vapor pressure will be enriched in the vapor state. Consequently, the component with the lower vapor pressure will be enriched in the liquid state.

A distillation column contains several trays, through which a vapor stream ascends and a liquid stream descends. On each tray they make contact, and there is an exchange of components and energy. The liquid becomes richer in the less volatile component, and the vapor becomes richer in the more volatile component. In this way the *feed*, containing two components, can be separated into two streams, both enriched in one of these two components.

A typical two-product distillation column and some of the peripheral equipment are shown schematically in Figure 6.1.

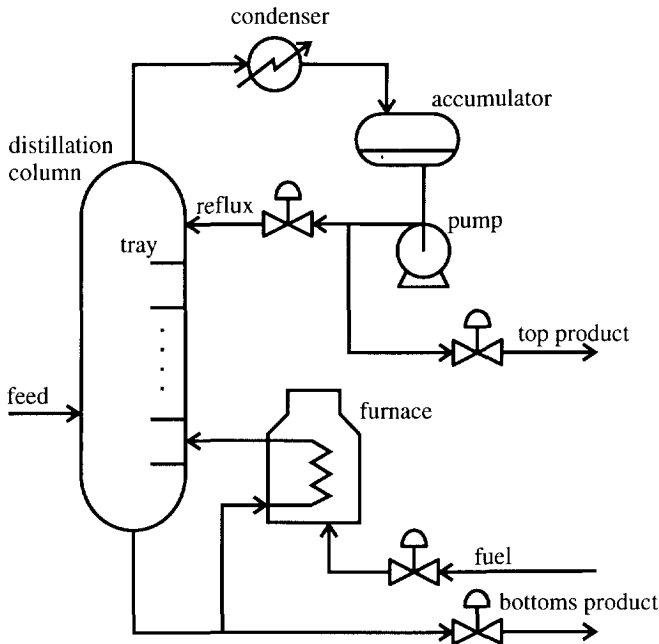

Figure 6.1. Two-product distillation column

The feed is a liquid with two components, which have to be separated. It usually comes from an upstream unit, and cannot be influenced directly, neither in volume, nor in concentration.

The vapor stream exits the column at the top, where it is condensed by the *condenser*, and collected in the *accumulator*. A pump removes the liquid from the accumulator, and part of it is fed back into the column. This is known as the *reflux*. The remaining part exits the distillation unit. This part is known as the *distillate* or the *top product*.

The liquid stream exits the column at the bottom. Part of it is fed through the *reboiler*, in which it is heated, back into the column. The remaining part exits the unit as the *residue* or the *bottoms product*.

The quality of the separation can be measured in terms of the purity of the top and the bottoms product. Usually the *impurity* of these products is measured for control purposes. The impurity of the top product is the concentration of the less volatile component in the top product. The impurity of the bottoms product is the concentration of the more volatile component in the bottoms product.

In general, there are constraints on the permitted impurity of both top and bottoms product. The control objective is then formulated in terms of satisfying these constraints with minimum energy consumption or maximum throughput.

Hence, as process outputs or *controlled variables*, the top and bottoms impurities are used. In this chapter they are denoted by  $y_{tq}$  and  $y_{bq}$ , respectively.

The *manipulated variables* or process inputs are the set points of two low-level controllers. The first controller controls the *internal reflux-to-feed ratio*, denoted by  $x_{irf}$ , by means of the valve in the reflux flow. The internal reflux flow is the flow of the liquid stream descending the column, and can be calculated from measurements of (external) reflux flow, temperatures and pressures.

The second controller controls the *cutpoint temperature*, denoted by  $x_{cp}$ , by means of the valve in the fuel flow to the furnace. The cutpoint temperature is the temperature of a specific tray in the column, and is closely related to the quality of the separation.

The set point of the internal reflux-to-feed ratio controller is denoted by  $u_{irf}$ , and the set point of the cutpoint temperature controller is denoted by  $u_{cp}$ .

The desired quality of separation is specified by the reference values for  $y_{tq}$  and  $y_{bq}$ , denoted by  $r_{tq}$  and  $r_{bq}$ , respectively.

To maintain the desired quality of separation, a controller is applied according to the Internal Model Control (IMC) principle (Morari and Zafriou, 1989). A dynamic model of the plant runs parallel to the plant, and measured and predicted outputs are subtracted. The resulting bias  $\varepsilon$  is fed back to the quality controller. This controller contains the inverse of the steady-state part of the model, and several constraints, and calculates new set points  $u_{irf}$  and  $u_{cp}$  on the basis of this information, and the reference values  $r_{tq}$  and  $r_{bq}$ . Currently, the model consists of four first order SISO transfer functions, characterized by a dead time, a gain and a time constant. The (normalized) values of this model are given in the next section.

The control configuration is shown schematically in Figure 6.2, where all kinds of ad-

ditional controllers (flows, temperatures, pressures, etc.) are assumed to be part of the distillation column.

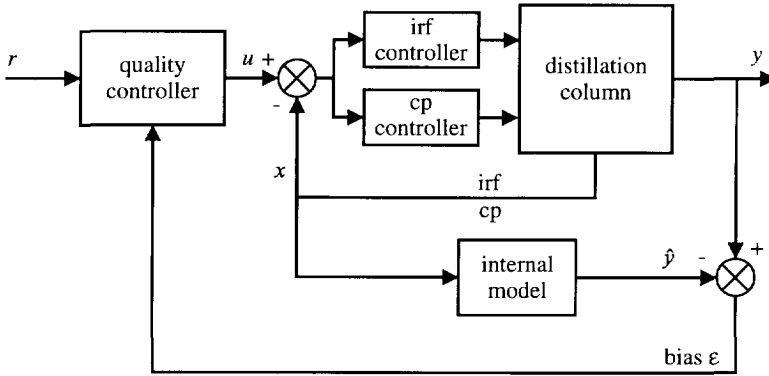

Figure 6.2. Control configuration of the distillation column, shown in Figure 6.1

With the current controller, the impurities of top and bottoms products are not controlled satisfactorily. The correlation between the set points  $u$  and the bias  $\varepsilon = y - \hat{y}$  is high, indicating that the internal model does not describe the process sufficiently well. For a perfect model, the bias consists of the external disturbances only, and there is no cross-correlation between  $u$  and  $\varepsilon$  for positive lags:  $R_{\varepsilon u}(\tau) = 0$  for  $\tau \geq 0$ . For negative  $\tau$  the cross-correlation is nonzero, which is caused by the presence of feedback.

The model quality is measured in terms of the cross-correlation between the set points and the bias. It is assumed that a model with a higher quality results in a controller that yields a higher performance.

The purpose of this investigation is therefore to identify a new model, which results in less correlation between  $u$  and  $\varepsilon$ . To this end, a closed-loop identification experiment has been designed, and carried out. The results are reported in the following sections. The scales in the plots are normalized.

### 6.3 Experiment design

Before designing an experiment, the boundaries of the system which is identified should be defined. The control configuration, shown in Figure 6.2 is simplified to fit into the schemes, as discussed in the previous chapters.

The process inputs and outputs are  $u = (u_{\text{irf}} \ u_{\text{cp}})'$  and  $y = (y_{\text{iq}} \ y_{\text{bq}})'$ , respectively. Excitation at the reference signal  $r = (r_{\text{iq}} \ r_{\text{bq}})'$  is not allowed, but an excitation signal

$\eta = (\eta_{\text{irf}} \ \eta_{\text{cp}})'$  can be added to the calculated controller output  $u$ .

The measured internal reflux-to-feed ratio and cutpoint temperature are  $x = (x_{\text{irf}} \ x_{\text{cp}})'$ , and their (low-level) controllers are denoted by  $K$ , as shown in Figure 6.3.

It is assumed that the plant, and all additional controllers, can be described by an LTI system  $G_0$ , which can be decomposed into two LTI systems  $G_x$  and  $G_y$ , as

$$G_0 = G_y G_x. \quad (6.1)$$

Finally, it is assumed that the IMC controller, denoted by  $Q$ , is LTI in the operating point.

The reference signal  $r$  is constant, and therefore not relevant to the dynamic behavior of the distillation column. The control configuration, shown in Figure 6.2, can then be drawn as shown in Figure 6.3.

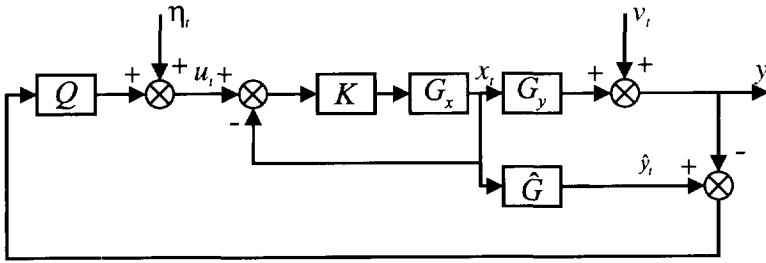

Figure 6.3. Control configuration

The signals  $\eta$ ,  $u$ ,  $x$ ,  $y$  and  $\hat{y}$  in Figure 6.3 are measurable. To determine which signals should be used for identification, we derive the equations that govern the dynamic loop behavior.

First we define  $\tilde{K}$  as

$$\tilde{K} = [I + G_x K]^{-1} G_x K \quad (6.2)$$

and derive

$$u_t = [I + Q(G_y - \hat{G})\tilde{K}]^{-1} \eta_t - [I + Q(G_y - \hat{G})\tilde{K}]^{-1} Q v_t \quad (6.3a)$$

$$x_t = \tilde{K} [I + Q(G_y - \hat{G})\tilde{K}]^{-1} \eta_t - \tilde{K} [I + Q(G_y - \hat{G})\tilde{K}]^{-1} Q v_t \quad (6.3b)$$

$$y_t = G_y \tilde{K} [I + Q(G_y - \hat{G})\tilde{K}]^{-1} \eta_t + [I - G_y \tilde{K} [I + Q(G_y - \hat{G})\tilde{K}]^{-1} Q] v_t \quad (6.3c)$$

and we observe that  $x$  plays the role of  $u$  in the Two-Step and Generalized Identification methods discussed in Chapter 2. Hence we should not use  $u$  as the input signal, but  $x$



instead!

We define the controller  $C$  as

$$C = [I - \tilde{K}Q\hat{G}]^{-1}\tilde{K}Q \tag{6.4}$$

and the fictitious excitation signal  $r$  as

$$r_t = [I - \tilde{K}Q\hat{G}]^{-1}\tilde{K}\eta_t. \tag{6.5}$$

Note that  $r_t$  is not an existing signal, and cannot be indicated in Figure 6.3. It is introduced to show the analogy with the configuration in Figure 1.2.

Then  $x_t$  and  $y_t$  become

$$x_t = [I + CG_y]^{-1}r_t - [I + CG_y]^{-1}Cv_t \tag{6.6a}$$

$$y_t = G_y[I + CG_y]^{-1}r_t + [I + G_yC]^{-1}v_t. \tag{6.6b}$$

With these equations the loop shown in Figure 6.3 can be simplified to the loop shown in Figure 6.4.

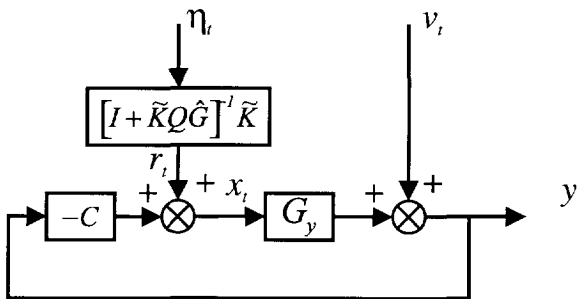

Figure 6.4. Simplified closed loop

From Figure 6.4, and (6.6), it can be seen that  $x_t$  is the signal that should be reconstructed in the TS or GI method. It is also the input signal for DI. Moreover, it follows that  $\hat{G}$  is a model of  $G_y$  only, and not of  $G_0$ .

The loop is excited by  $\eta$ , and  $[I - \tilde{K}Q\hat{G}]^{-1}\tilde{K}$  acts as a shaping filter.

Having established the inputs and outputs, and the location of the excitation signals, we have to determine the sampling times at which the data is collected and at which the model is built, and we have to decide upon the shape of an input signal.

### Sampling time

In the control system currently operating, there are three different sampling times:

- $T_m$ : the minimum possible sampling time, and the sampling time with which the model output  $\hat{y}$  and the bias  $\varepsilon$  are calculated,
- $T_c = 4T_m$ : the sampling time of the quality controller  $Q$ ,
- $T_o = 8T_m$ : the sampling time of the analyzers for the output measurements.

The systems that operate at these different sampling times are not synchronized.

The sampling times that need to be chosen are the sampling time for data acquisition,  $T_a$ , and the sampling time for modeling,  $T_s$ . The equipment enforces these sampling times to be an integer multiple of  $T_m$ .

The sampling time for data acquisition is chosen as small as possible, to lose as little information as possible.

However, since the output measurements become available every  $T_o$  seconds, it is of no use to build the model with a faster sampling rate, because we would lack the output data. Therefore we choose

$$T_s = T_o, \quad T_a = T_m. \quad (6.7)$$

Because of the difference between  $T_a$  and  $T_s$ , the data is resampled before building the model; the noise effects can thus be reduced. This is part of the data preprocessing, and it is discussed in Section 6.4.

### Input signal

The input signal is chosen as two independent Generalized Binary Noise (GBN) sequences (Section 5.3.3), and hence  $\xi = (A \ p \ T_b)'$ . The nonswitching probability  $p^*$  of both sequences is determined from the model that is currently used by the IMC controller. This model consists of four first order SISO transfer functions, specified in the continuous time domain. The values of the scaled gains  $K$ , the time constants  $\tau$  and the time delays  $T_d$  (in  $T_s$ ) are given in Table 6.1 for each transfer function. Note that there is no effect from internal reflux-to-feed ratio changes to the bottom quality. Note also that the sampling time  $T_s$  is in fact too slow, because the time constant of the transfer function from  $x_{cp}$  to  $y_{tq}$  is only 1.88 times  $T_s$ . This can deteriorate the data quality. However, it cannot be avoided, because the outputs are not available at a higher sampling rate.

|                    | from $x_{\text{irf}}$                                 | from $x_{\text{cp}}$                                |
|--------------------|---|---|
| to $y_{\text{iq}}$ | $K = -1.3950$<br>$\tau = 10.43T_s$<br>$T_d = 5.25T_s$ | $K = 0.5495$<br>$\tau = 1.88T_s$<br>$T_d = 1.25T_s$ |
| to $y_{\text{bq}}$ | $K = 0$   | $K = -0.5967$<br>$\tau = 3.98T_s$<br>$T_d = 2.5T_s$ |

Table 6.1. Scaled gains  $K$ , time constants  $\tau$  and time delays  $T_d$  of the current model

Because of the specification of the current model in time constants, we use Tulleken's (1990) rule of thumb to determine the optimal value of  $p$  for each GBN. This rule states that, for  $p^*$  which achieves minimum variance of the estimate, the following holds.

$$\mathbb{E}\{T_{sw}(p^*)\} = 2\tau_{\text{dom}} = \frac{T_b}{1 - p^*} \Rightarrow p^* = 1 - \frac{T_b}{2\tau_{\text{dom}}} \quad (6.8)$$

where  $\tau_{\text{dom}}$  is the dominant time constant.

Given  $T_b$  and  $\tau_{\text{dom}}$ ,  $p^*$  can be determined from (6.8). For both inputs,  $T_b = T_s = T_o$ , which is the sampling time at which the model is built. The parameters  $p$  then become:  $p_{\text{irf}} = 0.8204$  and  $p_{\text{cp}} = 0.8707$ . The amplitudes are chosen to comply with previous operator experience, namely  $A_{\text{irf}} = 0.05$  and  $A_{\text{cp}} = 0.2$ .

The experiment design is now completed. The results of the identification experiment are presented in the following section.

## 6.4 Identification results

First the preprocessing of the data is described. Then the dead time is estimated, and finally the identified models are presented. A discussion of the results concludes this section.

### 6.4.1 Data preprocessing

The data preprocessing consists of four steps:

1. Correction of outliers,
2. Trend removal,
3. Decimation,
4. Scaling.

**Ad 1.** Sensor failures can be the cause of outliers in the data. If the outliers are not corrected they will have a bad influence on the identification result, because the minimization procedure will try to fit the outliers as well as the correct data.

Outliers are detected by visual inspection of the data, as can be seen in Figure 6.5a, where the measured internal reflux-to-feed ratio is shown. The outlier is corrected by linearly

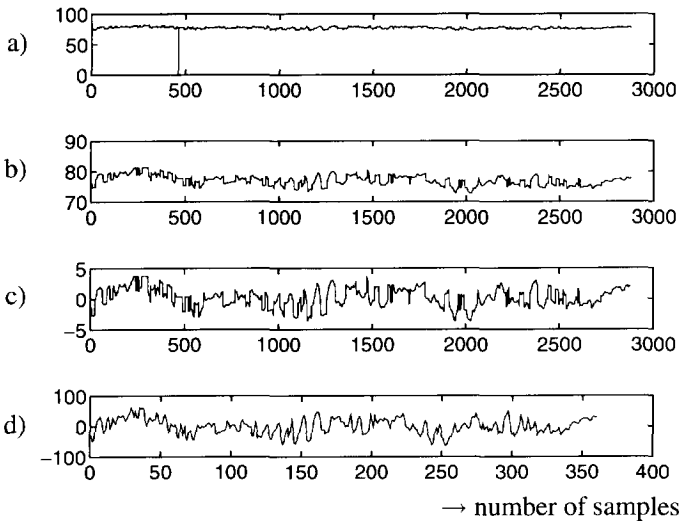

Figure 6.5. Measured internal reflux-to-feed ratio (a), after outlier correction (b), trend removal (c) and decimation and scaling (d)

interpolating between surrounding measurements. In Figure 6.5b, the outlier has been corrected.

**Ad 2.** Trends in the data cannot be explained by a linear model and should be removed before the identification procedure is started. The trend is estimated and subtracted from the measured signal. It consists of three parts:

1. A constant trend or offset, which is estimated by calculating the mean of the signal;
2. A linear trend, which is estimated by fitting a straight line to the signal;
3. A low-frequent trend, which is estimated by filtering the signal with the second order low-pass filter  $F_{\text{trend}}(z)$  (Falkus, 1994):

$$F_{\text{trend}}(z) = \frac{(1-p)^2 z^{-1}}{(1-pz^{-1})^2}. \quad (6.9)$$

This filter has a unit transfer for DC. The parameter  $p$  is derived from the trend period  $T_{\text{trend}}$ , which is determined visually as (Falkus, 1994)

$$p = e^{-2\pi\zeta/T_{\text{trend}}\sqrt{1-\zeta^2}} \quad (6.10)$$

where  $\zeta$  is the damping ratio of the filter (6.9), which is set to 0.89 to realize no overshoot and oscillation in the filter step response.

The signal is filtered both in the forward direction (causally) and in the backward direction (anti-causally), taking into account transient effects caused by nonzero values at the beginning and the end of the data sets (Matlab Signal Processing Toolbox).

The detrended signal is shown in Figure 6.5c.

**Ad 3.** The data has been acquired at a higher sampling rate than the sampling rate at which the model is built. Therefore it should be resampled. This operation is called *decimation*.

First the data is filtered with an anti-causal eighth order Butterworth filter, to prevent aliasing. Then each eighth sample is taken. As a result, the data set for identification contains  $N = 360$  samples.

Decimation is available as a standard function in Matlab (Ljung, 1991).

**Ad 4.** If the signals have different variance, their weights are different in the identification criterion. The higher the variance is, the larger is the weight. Since this weight generally depends on the specific units in which the signals are measured, it is undesirable. Therefore the signals are scaled, such that they all have a variance equal to one.

Each signal  $s_t$  is multiplied by a gain  $K_s$ , equal to the inverse of the standard deviation:

$$K_s = 1/\sqrt{R_s(0)}. \quad (6.11)$$

The DC gain of the models should be rescaled after the identification.

The decimated and scaled signal  $x_{\text{if}}$  is shown in Figure 6.5d.

**Remark 6.1** The filtering operations are performed on all signals in the data set. This is sometimes referred to as *parallel filtering* (Richalet, 1991), indicating that the filters are applied to both inputs and outputs.

In many cases, the data quality can be enhanced by parallel filtering with simple high-pass and low-pass filters.

The data, thus prepared, is used to identify the models. Due to the short data length, the data set cannot be split into an identification part and a validation part. This prohibits the use of cross-validation, and limits the power of the validation tests.

### 6.4.2 Dead-time estimation

The time delays are estimated with correlation analysis, as described in Section 3.2. The normalized cross-covariance functions are estimated from the data, and the 95% confidence interval is plotted, to see where the covariance function exceeds this limit. The dead time must be estimated for the models from  $\eta$  to  $x$  and from  $x$  to  $y$ .

The normalized cross-covariance function of  $\eta$  and  $x$  is shown, for the different transfers, in Figure 6.6 (solid). The dashed lines are the 95% confidence limits. The selected dead times are written below. The zeros on the diagonal indicate that the inner control loops are fast, compared to the outer quality control loop.

In Figure 6.7, the normalized cross-covariance function of  $x$  and  $y$  is shown (solid), together with the 95% confidence limits, and the estimated time delays.

The estimated time delays are confirmed by the cross-covariance function of  $x^r$  and  $y$ , which can be computed after  $x^r$  is reconstructed, as part of the first step of TS. The normalized cross-covariance function is shown in Figure 6.8.

Comparing the estimated time delays with those of the current model, given in Table 6.1, we see that there is quite a difference for  $y_{iq}$ . From the data set we conclude that the top quality reacts faster to changes in the internal reflux-to-feed ratio, but slower to cutpoint temperature changes. For  $y_{bq}$  there is no difference.

### 6.4.3 Identified models

In this section the models are presented, that have been obtained from the measured and pre-treated data. Identification is done with spectral analysis, Direct Identification, the Two-Step method and the Generalized Identification method. Note that  $S$  is in this case not the sensitivity function, but the system between  $\eta_t$  and  $x_t$  (cf. Figure 6.4).

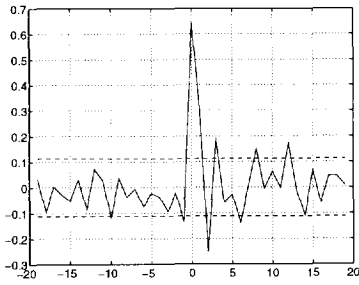

(a)  
 $\eta_{irf} \rightarrow x_{irf} : T_d = 0$

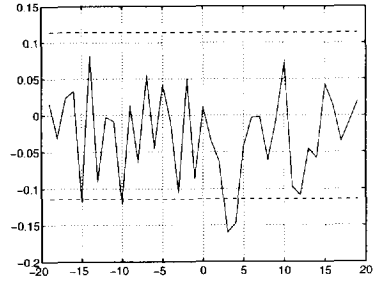

(b)  
 $\eta_{cp} \rightarrow x_{irf} : T_d = 3$

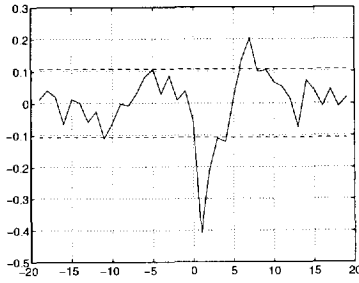

(c)  
 $\eta_{irf} \rightarrow x_{cp} : T_d = 1$

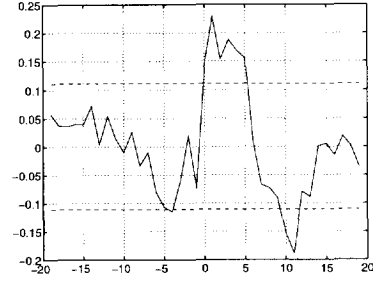

(d)  
 $\eta_{cp} \rightarrow x_{cp} : T_d = 0$

Figure 6.6. Normalized cross-covariance function of  $\eta$  and  $x$ , and 95% confidence limits, with the estimated time delays

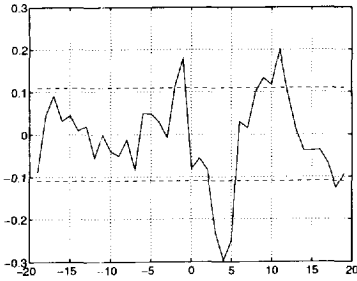

(a)  
 $x_{ift} \rightarrow y_{tq} : T_d = 3$

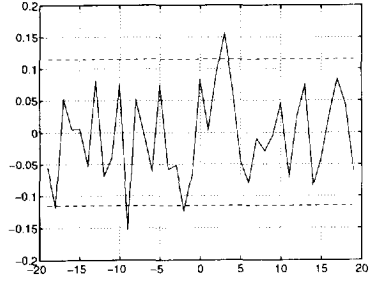

(b)  
 $x_{cp} \rightarrow y_{tq} : T_d = 3$

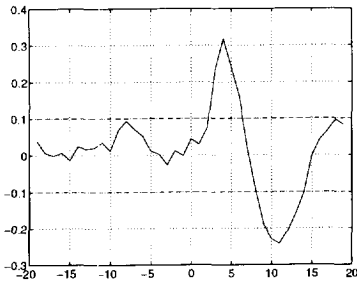

(c)  
 $x_{ift} \rightarrow y_{bq} : T_d = 3$

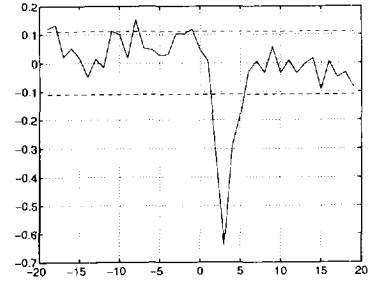

(d)  
 $x_{cp} \rightarrow y_{bq} : T_d = 2$

Figure 6.7. Normalized cross-covariance function of  $x$  and  $y$ , and 95% confidence limits, with the estimated time delays



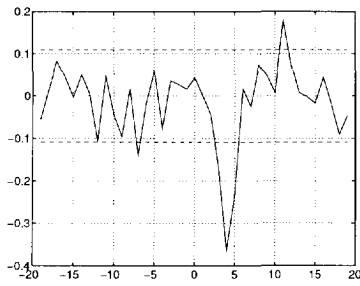

(a)  
 $x_{if}^r \rightarrow y_{tq} : T_d = 3$

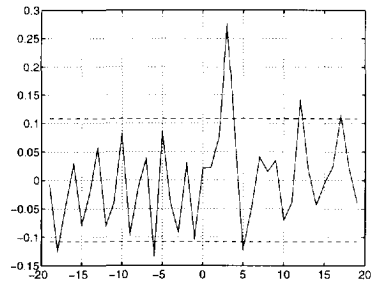

(b)  
 $x_{cp}^r \rightarrow y_{tq} : T_d = 3$

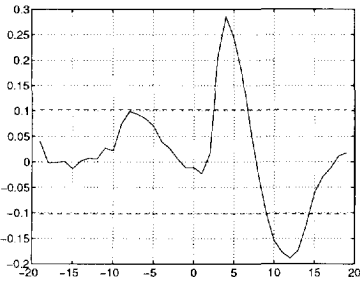

(c)  
 $x_{if}^r \rightarrow y_{bq} : T_d = 3$

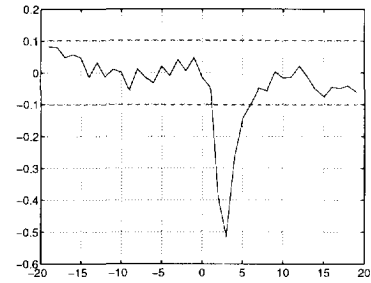

(d)  
 $x_{cp}^r \rightarrow y_{bq} : T_d = 2$

Figure 6.8. Normalized cross-covariance function of  $x^r$  and  $y$ , and 95% confidence limits, with the estimated time delays

To get a rough idea of the achievable model quality, the coherence  $C$  is calculated for different combinations of input signals and output signals. The coherence  $C_{xy}(\omega)$  of an input signal  $x$  and an output signal  $y$  is defined as

$$C_{xy}(\omega) = \frac{\Phi_{yx}(\omega)\Phi_{yx}^*(\omega)}{\Phi_x(\omega)\Phi_y(\omega)}, \quad 0 \leq C \leq 1 \quad (6.12)$$

The coherence is a measure for the linear relationship between two signals. If  $C_{xy}(\omega)$  is close to one, it can be expected that a reasonable linear model can be estimated between  $x$  and  $y$ . If  $C_{xy}(\omega)$  is close to zero, there is not much hope for a good linear model between  $x$  and  $y$ .

For multi-input systems, theoretically the sum of the coherences between all inputs and any output is smaller than one. However, because of their implementation, existing coherence estimation algorithms usually compute larger values. Therefore care must be taken in interpreting coherences.

In Figure 6.9 the different computed coherences are shown, as a function of the frequency  $\omega$ . From Figure 6.9a, showing the coherences of  $\eta$  and  $x$ , we see that a fairly good model  $\hat{S}$  can be expected for  $x_{\text{if}}$  (out #1). For  $x_{\text{cp}}$  (out #2), the coherence is smaller, and the resulting model might be less good.

Although there is no model identified between  $\eta$  and  $y$ , their coherence is shown in Figure 6.9b, to indicate that such a model would not be very good.

DI estimates a model  $\hat{G}$  between  $x$  and  $y$ , and their coherence, shown in Figure 6.9c, indicates that there is quite a strong linear relationship.

TS and GI estimate  $\hat{G}$  from  $x^r$  and  $y$ , after  $x^r$  is reconstructed from  $\hat{S}$ . In Figure 6.9d the coherence between one such signal  $\hat{x}^r$  and  $y$  is shown. It is somewhat smaller than the coherence between  $x$  and  $y$ , but still fairly good models can be expected.

It should be noted that the coherences only give an indication of the achievable model quality. They give no guarantee, and they should be interpreted with great care.

We start with the identification of  $S$  from  $\{x_t, \eta_t\}_N$ , which can be done with open-loop techniques. A spectral estimate  $\hat{S}_N$  is obtained as in (2.2) as

$$\hat{S}_N(e^{i\omega}) = \hat{\Phi}_{x\eta, N}(\omega)\hat{\Phi}_{\eta, N}^{-1}(\omega) \quad (6.13)$$

and its magnitude is shown as the solid line in Figure 6.10.

It appears that an FIR parametrization in both TS and GI gives meaningless results in the second step. Therefore an ORTFIR parametrization (Section 3.3) is used in both cases. The basis generating system  $G_b(z)$  is constructed from an initial ARX estimate of 10th order. This results in a model with 120 parameters, which is a lot compared to the data

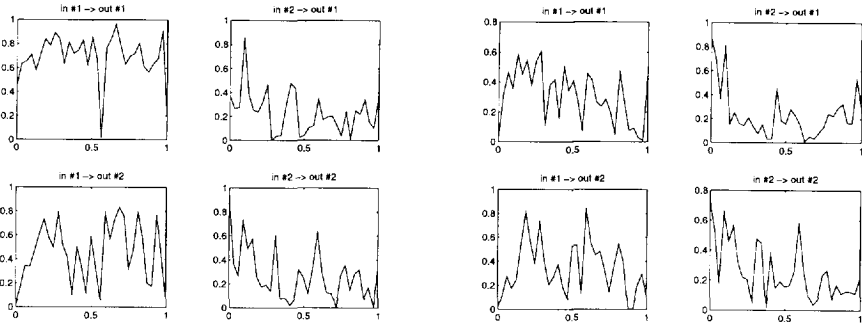

(a)  
Coherence  $\eta \rightarrow x$

(b)  
Coherence  $\eta \rightarrow y$

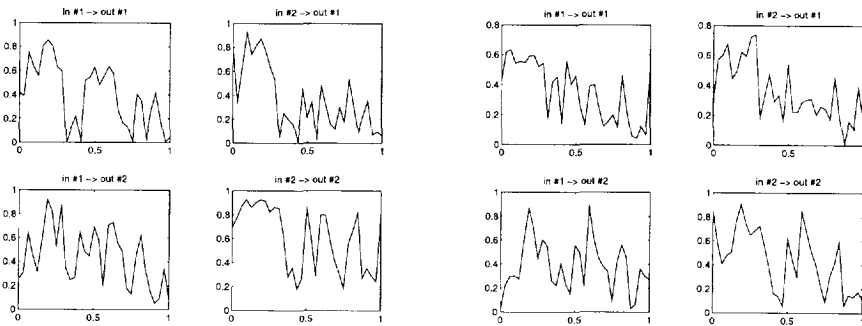

(c)  
Coherence  $x \rightarrow y$

(d)  
Coherence  $x^T \rightarrow y$

Figure 6.9. Coherences  $C$  versus frequency  $\omega (\times \pi)$

length  $N = 360$ . However, a lower order model does not give sufficiently good results. Both TS and GI come up with the same  $\hat{S}$ , of which the amplitude is shown in Figure 6.10 as the dashed line. The ORTFIR estimate appears to be in good agreement with the

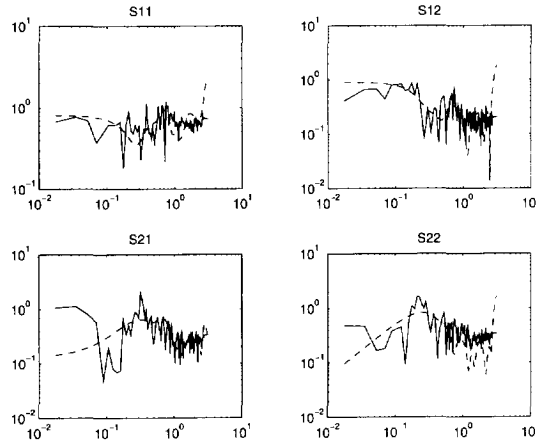

Figure 6.10. Bode amplitude plot of  $\hat{S}$  with spectral analysis (solid), TS and GI (dashed)

spectral estimate.

To validate the model  $\hat{S}$ , the cross-correlation function of the input  $\eta_t$  and the residual  $x_t - \hat{x}_t$  is calculated, together with the 99% confidence limits. They are shown in Figure 6.11a for  $x_{\text{inf}}$  and in Figure 6.11b for  $x_{\text{cp}}$ . In these figures we see that for positive lags the cross-correlation function lies well within the confidence interval. For negative lags, correlation indicates feedback, or in this case probably effects that stem from the short length of the data sequence. Hence we accept the model  $\hat{S}$ , and it is used to reconstruct  $x^r$ .

Note, however, that this is not a cross-validation test, since there is no validation set available. Therefore the identified  $\hat{S}$  might be good for the identification set, but not for other data sets.

Having identified  $S$ , we are ready to estimate models of  $G_y$ .

A spectral estimate  $\hat{G}_N$  is obtained as in (2.46), and its amplitude is shown in Figure 6.12 as the solid line. In view of the current controller implementation we want a parametric model that consists of four first order SISO transfer functions. As an intermediate we identify higher order models, from which the first order models can be obtained by model reduction. This enables us to analyze the difference in model quality between the different methods, and the loss of model quality as a consequence of the use of lower order models.

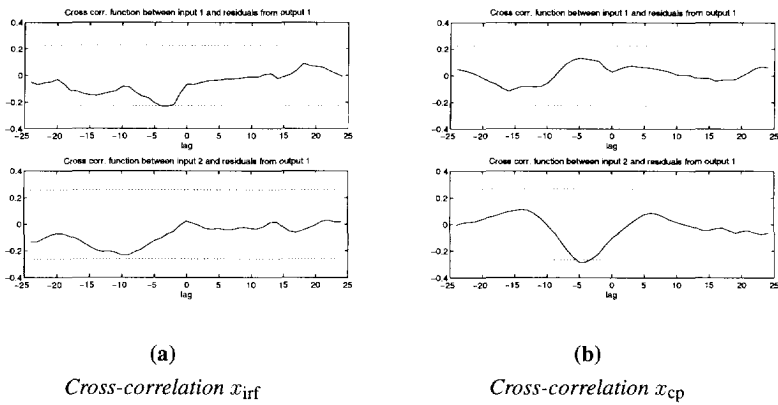

Figure 6.11. Cross-correlation function of inputs  $\eta$  and residuals  $x - \hat{x}$  and 99% confidence limits for  $\hat{S}$

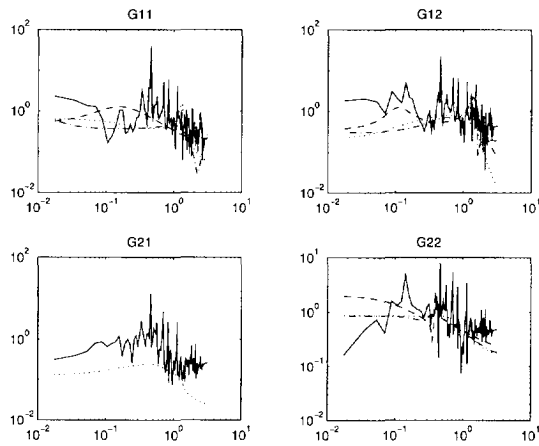

Figure 6.12. Bode amplitude plot of  $\hat{G}$  with spectral analysis (solid), TS (dashed), GI (dotted) and DI (dash-dotted)

High order models of  $G$  are identified with DI, TS and GI. The procedures have been implemented in Matlab, using the identification methods available in the System Identification Toolbox.

The best acceptable models that are obtained with DI and TS are MISO OE models, of fourth order. With GI, a fifth order MIMO OE model is identified (model structure  $(3, 2)$ ). The amplitude plots of these models  $\hat{G}$  are shown in Figure 6.12, where the solid line is the spectral estimate, the dashed line is the TS model, the dotted line is the GI model, and the dash-dotted line represents the DI model. In the MISO models, obtained with DI and TS, the transfer from  $x_{\text{irf}}$  to  $y_{\text{bq}}$  (G21) can be set to zero explicitly. In the MIMO GI model this is not possible, and therefore Figure 6.12 shows a frequency function for this transfer as well (dotted line).

No choice can be made regarding the validity of the models on the basis of the Bode plots only. Neither can it be decided which model is preferred. Therefore the step responses of the models are calculated, and shown in Figure 6.13. The dashed line is the step response of the TS model, the dotted line of the GI model and the dash-dotted line represents the DI model. They are compared with the step response of the current model (solid line). From

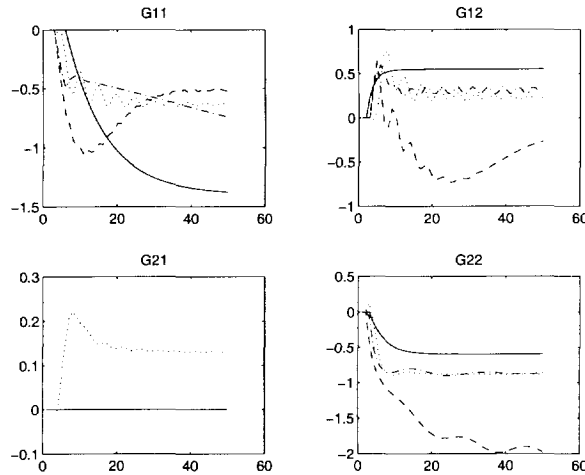

Figure 6.13. Step response plot of  $\hat{G}$  with current model (solid), TS (dashed), GI (dotted) and DI (dash-dotted)

this comparison we conclude that GI produces the most acceptable model. The TS model has the wrong sign of the gain for the transfer from  $x_{\text{cp}}$  to  $y_{\text{tq}}$  (G12), and a nonsatisfactory behavior for the transfer function from  $x_{\text{cp}}$  to  $y_{\text{bq}}$  (G22). The DI model is acceptable for the transfers from  $x_{\text{cp}}$  to both  $y_{\text{tq}}$  (G12) and  $y_{\text{bq}}$  (G22), but not for the transfer from  $x_{\text{irf}}$  to  $y_{\text{tq}}$  (G11). The GI model seems acceptable for all transfers.

Finally we calculate the cross-correlation functions of the inputs  $\hat{x}^r$  (TS and GI) or  $x$  (DI), and the residuals, on the basis of the identification set. Again this is no cross-validation, since there is no validation set available. The calculated cross-correlation functions and the 99% confidence limits are shown in Figure 6.14. In Figure 6.14a and 6.14b, the cross-correlation function is shown for the (MISO OE) DI model. For all transfers it remains within the 99% confidence limits, except for the transfer from  $x_{\text{irf}}$  to  $x_{\text{cp}}$  (which is zero). In Figure 6.14c and 6.14d, the cross-correlation function is shown for the (MISO OE) TS model. For both outputs it remains within the 99% confidence limits. However, the MISO OE models have a large number of parameters (40). The data set is in fact too short to reveal possible misfits in the models, especially since there is no separate validation set. Hence, although the validation test does not indicate that the models should be rejected, serious doubts exist as to the validity of the models. In Figure 6.14e and 6.14f, the cross-correlation function is shown for the (MIMO OE) GI model. It does not remain within the confidence limits, and should therefore be rejected. From the residual analysis we conclude that TS provides the best model. This is in contradiction with the earlier conclusion that the GI model is the best model.

The IMC controller needs four first order SISO models. To create these, the GI model is approximated by four independent SISO models. The emphasis is put on obtaining the same DC gain, except for the transfer from  $x_{\text{irf}}$  to  $y_{\text{bq}}$  (G21), which is set to zero. The step responses of the resulting first order models are shown in Figure 6.15 as the dashed lines. They are compared with the current model (solid) and the higher order GI model (dotted). The approximation of the GI model by first order SISO models necessarily leads to a loss of dynamics in the model. The first order models indicate a somewhat faster response than is currently implemented.

Finally, in Figure 6.16 we compare the measured outputs (solid lines) with the simulated outputs from the MIMO GI model (dotted), the first order SISO GI models (dashed) and the current model (dash-dotted). It can be disputed whether the new models, both high order and SISO, are better than the current model. A final validation test is done by calculating the cross-correlation function of the input  $\hat{x}^r$  and the residuals for the current model (Figures 6.17a and 6.17b) and for the SISO GI models (Figures 6.17c and 6.17d). Neither model can be accepted, because the cross-correlation functions lie outside the confidence region. The new model seems to be slightly better. However, the reliability of the validation test is limited due to the absence of a validation set.

To be able to evaluate the quality of the models, the ultimate validation should be performed: the new first order SISO models should be implemented in the IMC controller, and the performance should be evaluated. However, due to time limitations this was not possible within the scope of this thesis.

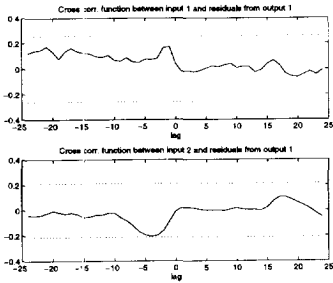

(a)

Cross-correlation  $y_{iq}$  for DI

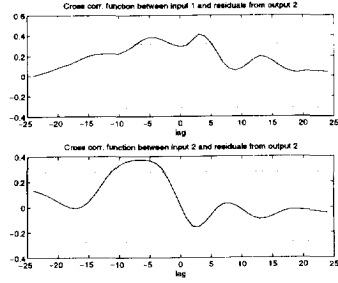

(b)

Cross-correlation  $y_{bq}$  for DI

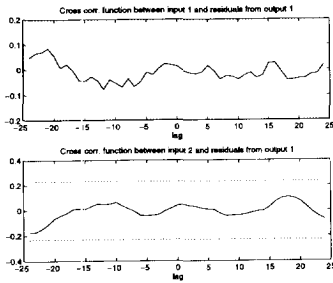

(c)

Cross-correlation  $y_{iq}$  for TS

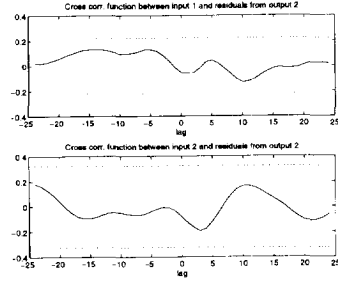

(d)

Cross-correlation  $y_{bq}$  for TS

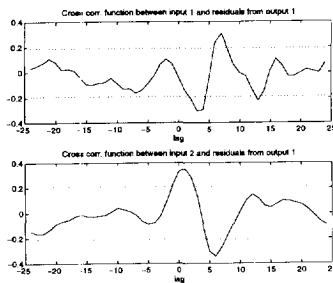

(e)

Cross-correlation  $y_{iq}$  for GI

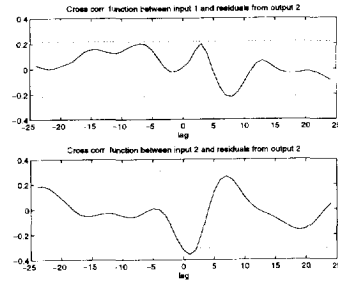

(f)

Cross-correlation  $y_{bq}$  for GI

Figure 6.14. Cross-correlation function of inputs and residuals and 99% confidence limits for  $\hat{G}$



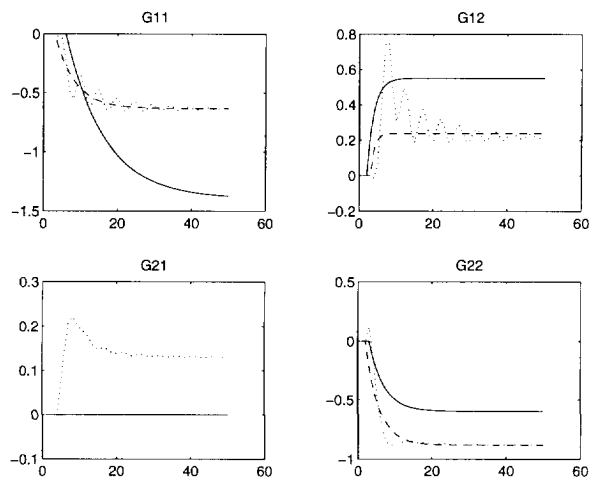

Figure 6.15. Step response plot of  $\hat{G}$  with current model (solid), first order GI model (dashed), and higher order GI model (dotted)

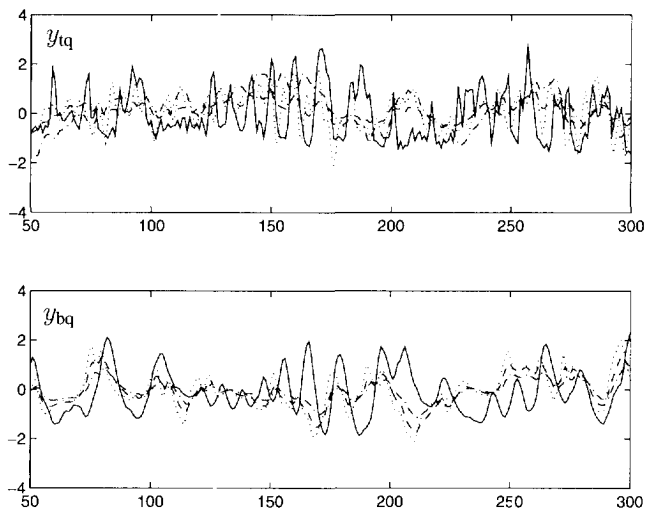
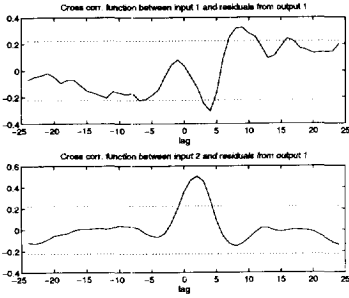
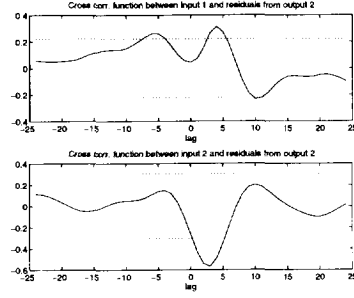

Figure 6.16. Measured outputs (solid), and simulated outputs with the first order GI model (dashed), the higher order GI model (dotted) and the current model (dash-dotted)



(a)

Cross-correlation  $y_{1q}$  for current model



(b)

Cross-correlation  $y_{bq}$  for current model

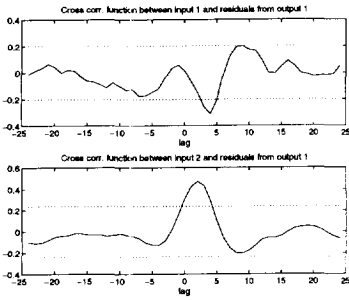

(c)

Cross-correlation  $y_{1q}$  for GI

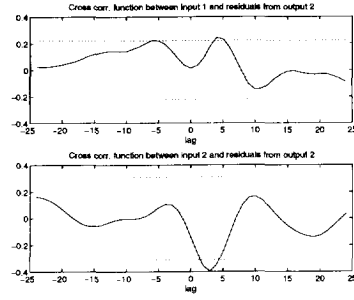

(d)

Cross-correlation  $y_{bq}$  for GI

Figure 6.17. Cross-correlation function of inputs and residuals and 99% confidence limits for  $\hat{G}$ , consisting of four SISO transfer functions

### 6.4.4 Discussion

It is clear that the quality of the identified models is rather poor. In this section, we investigate possible causes of the doubtful results, and make suggestions how to improve the reliability in future experiments.

Possible causes of the results are:

- nonlinearities and nonstationarity in the process;
- the absence of synchronization between the measurements and the controller;
- the large sampling time (too large, cf. Table 6.1);
- the short data length (only 360 samples) in relation to the number of model parameters (30–80);
- a small amplitude of the excitation signal.

The effect of nonlinearities and nonstationarities in both process and controller is unknown. Since they are properties of the process and its environment, they cannot be influenced either. However, some of the external disturbances, such as outside temperature and feed composition, are predictable. One can then try to carry out the experiments under almost constant external conditions.

The absence of synchronization is mainly due to the analyzers, which measure the impurity of the top and bottoms products. It is not known beforehand when a new measurement becomes available, and therefore synchronization is not easy to achieve. Again, although a possible cause of the unsatisfactory results, it cannot easily be influenced to yield better future results.

It seems that the main cause of the poor results which can be influenced is the large sampling time in combination with the short data length  $N$ , in relation to the number of model parameters  $d$ . The  $\hat{S}$  models indicate that the process contains higher order dynamics, but these cannot be identified because the ratio  $d/N$  is too large. The number of samples  $N$  is much too small to capture the high order dynamics.

Consequently, the data length must be increased to improve the identification results. This can be done by increasing the experiment length, but this could result in a larger effect from nonstationary outside influences, such as temperature and feed quality, thus deteriorating the quality of the data set.

A better way to increase  $N$  is by reducing the sampling time for identification. The existing analyzers, however, do not operate at a smaller sampling time. Consequently,

simply increasing the sampling time does not provide more output information, and it cannot be expected that the model quality is improved.

This problem can be solved, for example, as follows. If there are other signals, such as pressures and temperatures, which have a clear relationship with the impurities, these can be used to predict the impurity. Assuming that these signals can be measured at a higher sampling rate and an appropriate model can be obtained, predictions of the impurity can be used as output measurements. These predictions must be updated every time a new impurity measurement becomes available.

In this way a larger data set is obtained with the same experiment duration. Experiment design must be based on this higher sampling rate.

Increasing the amplitude of the excitation signals results in a larger signal-to-noise ratio. But the data set might suffer more from nonlinearities, which in turn deteriorates the quality of the data set. Moreover, too large variations in the output quality are not allowed. Hence this is not the most promising improvement.

Finally, we observe that the current controller implementation uses first order SISO models only. Hence the higher order dynamics cannot be captured by the controller. It is a valid question whether different first order models will result in a higher performance. In other words, the currently implemented controller might be robust against changes in the model. The basic assumption that a better model results in a controller that yields a higher performance, might not be justified. In that case, it is of no use to put effort in improving the model.

## 6.5 Conclusions

In this chapter we have discussed the application of closed-loop identification to a two-product distillation column. To investigate the possible advantages offered by the methods, developed in the previous chapters, a pilot plant setup would have been required. However, the limited availability of an experimental setup has forced us to restrict our attention to closed-loop identification methods only.

The distillation column is controlled according to the IMC principle, and for our research it has two inputs and two outputs. The inputs are the set points of two low-level controllers, and the outputs are the impurities of the top and the bottoms products. Excitation is possible at the set points of the low-level controllers.

It is shown in Section 6.3 that, for identification, the measured signal  $x$  should be regarded as the process input, instead of the set points  $u$ .

The choice of sampling times has been discussed, and the input signal is chosen to be a GBN sequence.

Data preprocessing has been considered in Section 6.4. It consists of the correction of outliers, trend removal, decimation and scaling. The resulting data length  $N$  is 360, which is too short to split the data set into an identification part and a validation part.

The dead times of the different transfers have been estimated by correlation analysis. The calculated coherences indicate that good models might be obtainable, but the results with DI, TS and GI are rather doubtful and cannot be validated.

An analysis of possible causes of the results has identified the limited number of data samples as the main cause. The description of the high order dynamics requires relatively too many parameters.

A possible solution is the increase of the sampling rate. If faster analyzers are not available, output data must be calculated from measurements of related variables, which are available at a higher sampling rate. These calculated outputs can be updated each time the analyzers give a new measurement.

A new data set can thus be obtained with the same experiment length, but a larger number of data. It is expected that the identification results will then improve.



## Chapter 7

---

# Conclusions

### 7.1 Contributions of the thesis

The problem, formulated and addressed in this thesis, has arisen from the needs of the process industry. Increasingly stringent demands on productivity, efficiency and flexibility requires controllers with high closed-loop performance. To design these controllers accurate models are needed, describing the behavior of the processes. These models are obtained by applying identification techniques to measured process data. Economic and safety constraints require that the experiments that provide the process data, are carried out in a closed-loop situation. Hence, the problem was formulated in Section 1.2 as: can we obtain a model  $\hat{G}$  of the plant  $G_0$  shown in Figure 1.2, with which the control performance can be enhanced through redesign of  $C_f$  and  $C_b$ , while taking into account the specific characteristics of the process industry, mentioned on page 3?

This brings about several aspects that have been addressed. The specific contributions of the thesis are in the following areas.

**Closed-loop identification** – A generalization of closed-loop identification procedures, which are based on the Prediction Error Method, has been proposed. Prefilters have been introduced to influence the bias in a suitable way. This generalization enables the analysis of several related schemes that appear to be special cases of the generalized procedure.

**Model structure selection** – A procedure has been proposed, with which a suitable model structure can be selected for multivariable systems. The procedure is easy to implement, and requires only a limited amount of computations.

**Lattice algorithms** – Lattice algorithms have been derived for the on-line identification of SISO models with more complex parametrizations than AR and ARX. The advantages of these algorithms are that they provide models of different orders

simultaneously, they are fast and computationally robust, and appear to work well in comparison to nonlattice implementations of the Recursive Prediction Error Method. Convergence of the Lattice Extended Least Squares method has been proven.

**Control-relevant identification** – An internal loop has been introduced in the general iterative scheme of closed-loop identification and controller design, presented in Figure 4.1. The iterative scheme now contains two loops. The external loop consists of experiment design, closed-loop identification, controller design and controller implementation. The internal loop uses the designed controller, before it is implemented, to redesign the filters in the identification step. In this way the bias distribution can be shaped to suit the needs of the controller (e.g. small error near the closed-loop bandwidth). Controller design can be incorporated in the identification phase, and the number of experiments can be reduced.

Convergence of the scheme cannot be guaranteed, and the results of each iteration should be monitored to decide whether to continue or to terminate the iterations.

Specific identification filters have been proposed for the Zang scheme for LQ control.

**Optimal input design** – Two new procedures have been proposed to design an input signal for identification. The first procedure is based on minimizing scalar functions of the weighted Hessian of the identification criterion with respect to the parameters. The second procedure is based on the Hessian of the identification criterion with respect to the frequency function, and has been developed for both open-loop and closed-loop identification. The minimization of these functions results in an optimal input protocol, in the sense that the uncertainty of the model is minimized.

The location of the excitation signal in a closed-loop experiment appears not to influence the identification results, and can therefore be chosen according to the requirements of the process and the available equipment.

**Distillation column experiment** – A closed-loop identification experiment has been carried out on a two-product distillation column. The resulting models do not seem reliable. Validation results are doubtful, as the number of data is too small to split the data set into an identification and a validation set.

Unfortunately, because of a lack of time we have not been able to evaluate the performance of a new controller, based on the new model, when applied to the process.

The results provide a starting-point as to how closed-loop identification should be performed in terms of algorithms and experiments.



## 7.2 Recommendations for future research

In the following areas some questions remain open.

**Lattice algorithms** – Lattice algorithms should be extended to multivariable systems.

Some preliminary work has been done in this area, and it shows that it is indeed possible to derive lattice algorithms for MIMO systems.

Another point of interest is a more thorough analysis of why lattice algorithms perform better than conventional nonlattice implementations, although they are based on the same Prediction Error criterion.

Proofs of convergence of lattice algorithms, other than LELS, should be found, although this is not easy, since convergence has not yet been proven for the standard Recursive Prediction Error Method either.

**Control-relevant identification** – There are several items in control-relevant identification that should receive and are receiving more attention:

- The convergence of the iterative scheme to a specific controller remains an unsolved problem. Monitoring possible performance enhancement in the iterations is hardly satisfactory, and it should be investigated under what conditions the iterations converge.

However, the question is whether convergence can be proven at all, since two different cost criteria are minimized in turn, and no overall criterion can be used.

- The triangle inequality provides an *a posteriori* upper bound on the achieved control performance cost. The calculation of an *a priori* upper bound would be convenient, because then it can be determined whether the controller will yield a higher performance, before it is implemented.

It is likely that the upper bound is conservative, in which case a decreased upper bound does not guarantee a decrease of the achieved performance cost. Moreover, the upper bound is based on asymptotic conditions ( $N \rightarrow \infty$ ). Since these will not occur in practice, calculations depend on the specific noise realization. A guaranteed performance then has no meaning for other realizations.

- The identification filters for LQ control design have been theoretically designed. Since they cannot be computed, they have to be approximated. A reasonable approximation has been proposed, but further research should reveal whether this is a good choice, or if a better approximation exists.
- The choice of the identification filters has only been considered for LQ control design. Although it can be expected that similar results will be found for other control design techniques, this should be confirmed by research.

**Model validation** – Model validation has only been considered in terms of open-loop validation. However, the area of control-relevant model validation is still unexplored, and should receive more attention.

**Input design** – In the process industry there is a need for MIMO input design, because of the coupling between many input and output variables. The proposed optimal input design procedures have been developed for SISO systems. Although many of the derivations carry over to the multivariable case, the procedures are not directly applicable. The research should include the effect of dependence (correlation) between multiple input signals, when applied to a multivariable process.

In the discussion of the weighting matrix  $W$ , reflecting the relative importance of a small variance for specific parameters or frequencies, it is left to the modeler to decide which parameters or frequencies should be emphasized. Tools should be developed to help the modeler to choose suitable parameters or frequencies.

Finally, the derivations given in Chapter 5 hold in the case  $S \in \mathcal{M}$ . In the more general case that  $S \notin \mathcal{M}$  but  $G_0 \in \mathcal{G}$ , the determinant of the Hessian is still a measure of the volume of the uncertainty ellipsoid, but the orientation of the iso- $V$ s and the uncertainty ellipsoids are probably different. Hence the determinant criterion can still be used for input design but the others cannot, because they are based on the orientation of the iso- $V$ s.

Under what conditions the orientations of the iso- $V$ s and the uncertainty ellipsoids are the same should be investigated. Or perhaps it is possible to calculate a weighting of the Hessian, such that the weighted Hessian has the same orientation as the uncertainty ellipsoids. In the latter case the Hessian can be replaced by the weighted Hessian in the input design criteria.

**Distillation column experiment** – To complete one iteration in the iterative scheme of identification and controller design, a controller should be designed on the basis of the new model. The evaluation of the resulting closed-loop performance then indicates whether or not the new model has improved with respect to the currently implemented model.

To improve the reliability of future experiments, longer data sets are required. The suggestion to obtain output data at a higher sampling rate by using other, related measurements, should be investigated with a view to its applicability.

The field of identification is developing in the direction of practical applications. Procedures for approximate modeling (also under closed-loop conditions), experiment design and the identification of models specifically for the design of (better) controllers, become available on a larger scale. As a consequence, there is a substantial increase in the possibility to successfully realize projects of identification and controller design in the process industry. This will result in better and more efficiently operating production plants.

# Appendix A

---

## Matrix calculus

In this appendix some of the concepts of matrix calculus are provided. Gantmacher (1977), Defant (1993), and the appendices of Lewis (1986) and Anderson and Moore (1989) are good references.

### A.1 Matrix definitions

The *determinant* of a matrix  $A \in \mathbb{R}^{n \times n}$  is denoted as  $\det A$ . For  $s \in \mathbb{R}$ ,

$$\det(sA) = s^n \det(A) \tag{A.1}$$

The *Kronecker product* of two matrices  $A = [a_{ij}] \in \mathbb{C}^{m \times n}$  and  $B = [b_{ij}] \in \mathbb{C}^{p \times q}$  is

$$A \otimes B = [a_{ij} B] \in \mathbb{C}^{mp \times nq} \tag{A.2}$$

The length of a vector  $x \in \mathbb{R}^n$  is denoted by  $|x|$ , and defined as

$$|x| = \sqrt{x'x} \tag{A.3}$$

If  $x \in \mathbb{C}$ ,  $|x|$  is the radius of the complex number

$$|x| = x\bar{x} \tag{A.4}$$

where  $\bar{x}$  is the complex conjugate of  $x$ .

## A.2 Matrix calculus

Let  $\theta \in \mathbb{R}^n = [\theta_1 \ \theta_2 \ \cdots \ \theta_n]'$  be a vector,  $s(\theta) \in \mathbb{R}$  be a scalar function of  $\theta$ ,  $f(\theta) \in \mathbb{R}^m$  be an  $m$ -vector function of  $\theta$ , and  $A(\theta) \in \mathbb{R}^{p \times m}$  a  $p \times m$  matrix function of  $\theta$ . The *gradient* of  $s$  with respect to  $\theta$  is the row vector

$$\frac{\partial s}{\partial \theta} = \left( \frac{\partial s}{\partial \theta_1} \quad \frac{\partial s}{\partial \theta_2} \quad \cdots \quad \frac{\partial s}{\partial \theta_n} \right) \quad (\text{A.5})$$

The *Hessian* of  $s$  with respect to  $\theta$  is the second derivative

$$\frac{\partial^2 s}{\partial \theta^2} = \left[ \frac{\partial^2 s}{\partial \theta_i \partial \theta_j} \right] \quad (\text{A.6})$$

which is a symmetric  $n \times n$  matrix.

The *Jacobian* of  $f$  with respect to  $\theta$  is the  $m \times n$  matrix

$$\frac{\partial f}{\partial \theta} = \left[ \frac{\partial f}{\partial \theta_1} \quad \frac{\partial f}{\partial \theta_2} \quad \cdots \quad \frac{\partial f}{\partial \theta_n} \right] \quad (\text{A.7})$$

The chain rule is

$$\underbrace{\frac{\partial}{\partial \theta}}_{m \times n} (s f) = \frac{\partial}{\partial \theta} (f s) = s \frac{\partial f}{\partial \theta} + f \frac{\partial s}{\partial \theta} \quad (\text{A.8})$$

and for two vector functions  $f$  and  $y \in \mathbb{R}^m$

$$\frac{\partial}{\partial \theta} (y' f) = \frac{\partial}{\partial \theta} (f' y) = y' \left[ \frac{\partial f}{\partial \theta} \right] + f' \left[ \frac{\partial y}{\partial \theta} \right] \quad (\text{A.9})$$

Finally,

$$\underbrace{\frac{\partial}{\partial \theta}}_{p \times n} (A f) = A \underbrace{\frac{\partial f}{\partial \theta}}_{m \times n} + \underbrace{\frac{\partial A}{\partial \theta}}_{p \times m \times n} f \quad (\text{A.10})$$

Suppose that  $s = f^* f$  with  $f \in \mathbb{C}^m$ . Then the chain rule gives

$$\frac{\partial s}{\partial \theta} = \frac{\partial s}{\partial f} \frac{\partial f}{\partial \theta} + \frac{\partial s}{\partial \bar{f}} \frac{\partial \bar{f}}{\partial \theta} \quad (\text{A.11})$$

$$= \bar{f}' \frac{\partial f}{\partial \theta} + f' \frac{\partial \bar{f}}{\partial \theta} \quad (\text{A.12})$$

## A.3 Matrix Inversion Lemma

Suppose that  $A$  and  $C$  are nonsingular matrices (not necessarily of the same dimension), and  $B, D$  are such that  $A + BCD$  exists and is nonsingular. Then

$$(A + BCD)^{-1} = A^{-1} - A^{-1}B(DA^{-1}B + C^{-1})^{-1}DA^{-1} \quad (\text{A.13})$$

with  $DA^{-1}B + C^{-1}$  guaranteed to be nonsingular.

## A.4 Two-norm

Consider a quasi-stationary signal  $x_t \in \mathbb{R}^n$ . Its two-norm is denoted by  $\|x_t\|_2$ , and is defined as

$$\|x_t\|_2 = \left( \overline{\mathbb{E}}\{x'_t x_t\} \right)^{1/2} = \left( \text{tr} \overline{\mathbb{E}}\{x_t x'_t\} \right)^{1/2} \quad (\text{A.14})$$

where  $\overline{\mathbb{E}}$  is the generalized expectation operator.

Let  $\Phi_x(\omega)$  be the spectrum of  $x$ . Then (A.14) is equivalent to

$$\|x_t\|_2 = \left( \text{tr} \frac{1}{2\pi} \int_{-\pi}^{\pi} \Phi_x(\omega) d\omega \right)^{1/2}. \quad (\text{A.15})$$

Let  $x_t$  now be the result of filtering a zero mean white noise sequence  $e_t$  with unit variance, through a stable LTI filter  $H \in \mathbb{R}^{n \times n}(z)$ :

$$x_t = H(q)e_t. \quad (\text{A.16})$$

Then the spectrum  $\Phi_x(\omega)$  is given by

$$\Phi_x(\omega) = H(e^{i\omega})H^*(e^{i\omega}). \quad (\text{A.17})$$

The two-norm of  $H(z)$  is the norm of the output signal  $x_t$ , when the input signal is  $e_t$ :

$$\|H(z)\|_2 \triangleq \|x_t\|_2 = \left( \text{tr} \frac{1}{2\pi} \int_{-\pi}^{\pi} H(e^{i\omega})H^*(e^{i\omega}) d\omega \right)^{1/2}. \quad (\text{A.18})$$

As a consequence, we can write the two-norm of any quasi-stationary signal as the semi-norm of an equivalent stable LTI shaping filter.



---

## Literature

- Aling, H. (1990): *Identification of Closed Loop Systems — Identifiability, Recursive Algorithms and Application to a Power Plant*, PhD Thesis, Delft University of Technology, the Netherlands.
- Aling, H., and O.H. Bosgra (1990): "Structural identifiability conditions for systems operating in closed loop", in *Realization and Modelling in System Theory* (M.A. Kaashoek, J.H. Van Schuppen and A.C.M. Ran Eds.) Birkhäuser, Boston, MA, pp. 421–428.
- Anderson, B.D.O. and M.R. Gevers (1979): "Identifiability of closed loop systems using the joint input–output identification method", *Proc. of the 5th IFAC Symposium on Identification and System Parameter Estimation*, Darmstadt, FRG, pp. 645–652.
- Anderson, B.D.O. and M.R. Gevers (1982): "Identifiability of linear stochastic systems operating under linear feedback", *Automatica*, **Vol. 18**, No. 2, pp. 195–213.
- Anderson, B.D.O. and M.R. Gevers (1983): "On the minimality of feedback realizations", *Int. J. Control*, **Vol. 37**, No. 1, pp. 145–158.
- Anderson, B.D.O. and J.B. Moore (1989): *Optimal Control – Linear Quadratic Methods*, Prentice-Hall, Englewood Cliffs, NJ.
- Anderson, B.D.O. and R.L. Kosut (1991): "Adaptive robust control: on-line learning", *Proc. 30th Conf. Decision and Control*, Brighton, UK, pp. 297–298.
- Aoki, M. (1987): *State Space Modelling of Time Series*, Springer-Verlag, New York.
- Åström, K.J., and B. Wittenmark (1989): *Adaptive Control*, Addison-Wesley, Reading, MA.
- Åström, K.J. (1993): "Matching criteria for control and identification", *Proc. of the European Control Conf.*, Groningen, The Netherlands, pp. 248–251.

- Åström, K.J. and J. Nilsson (1994): "Analysis of a scheme for iterated identification and control", *Preprints of the 10th IFAC Symposium on System Identification (SYSID)*, Copenhagen, Denmark, pp. 2.171–2.176.
- Aude, E.P.L. and D.J. Sandoz (1986): "Analysis of closed-loop systems using least-squares methods", *Int. J. Control*, **Vol. 43**, No. 2, pp. 561–585.
- Backx, T. (1987): *Identification of an Industrial Process: a Markov Parameter Approach*, PhD Thesis, Eindhoven University of Technology, the Netherlands.
- Bauer, B. and H. Unbehauen (1978): "On-line identification of a load-dependent heat exchanger in closed loop using a modified instrumental variable method", *Proc. 7th IFAC World Congress*, Helsinki, Finland, pp. 351–359.
- Beghelli, S., R.P. Guidorzi and U. Soverini (1987): "Structural identification of multivariable systems by the eigenvector method", *Int. J. Control*, **Vol. 46**, No. 2, pp. 671–678.
- Bitmead, R.R., M. Gevers and V. Wertz (1990): *Adaptive Optimal Control – the Thinking Man's GPC*, Prentice Hall, Englewood Cliffs, NJ.
- Bitmead, R.R. and Z. Zang (1991): "An iterative identification and control strategy", *Proc. of the European Contr. Conf.*, Grenoble, France, pp. 1396–1400.
- Bitmead, R.R. (1993): "Iterative control design approaches", *Prepr. 12th IFAC World Congress*, Sydney, Australia, **Vol. 9**, pp. 381–384.
- Butterfield, M.H. and P.J. Thomas (1986): "Methods of quantitative validation for dynamic simulation models", *Trans. of the Institute of Measurement and Control*, **Vol. 8**, No. 4.
- Caines, P.E. and C.W. Chan (1975): "Feedback between stationary stochastic processes", *IEEE Trans. Autom. Contr.*, **Vol. AC-20**, No. 4, pp. 498–508.
- Caines, P.E. and C.W. Chan (1976): "Estimation, identification and feedback", in *System Identification: Advances and Case Studies* (R.K. Mehra and D.G. Lainiotis Eds.), Academic Press, New York, pp. 349–406.
- Clarke, D.W., C. Mohtadi and P.S. Tuffs (1987a): "Generalised Predictive Control – Part I: the basic algorithm", *Automatica*, **Vol. 23**, No. 2, pp. 137–148.
- Clarke, D.W., C. Mohtadi and P.S. Tuffs (1987b): "Generalised Predictive Control – Part II: extensions and interpretations", *Automatica*, **Vol. 23**, No. 2, pp. 149–160.
- Corrêa, G.O. and K. Glover (1982): "Multivariable identification using pseudo-canonical forms", *Preprints of the 6th IFAC/IFORS Symp. on Identification and System Parameter Estimation*, Washington D.C., USA, pp. 1241–1246.



- Corrêa, G.O. and K. Glover (1984a): "Pseudo-canonical forms, identifiable parametrizations and simple parameter estimation for linear multivariable systems: input output models", *Automatica*, **Vol. 20**, pp. 429–442.
- Corrêa, G.O. and K. Glover (1984b): "Pseudo-canonical forms, identifiable parametrizations and simple parameter estimation for linear multivariable systems: parameter estimation", *Automatica*, **Vol. 20**, pp. 443–452.
- De Callafon, R.A., P.M.J. Van den Hof and M. Steinbuch (1993): "Control relevant identification of a compact disc pick-up mechanism", *Proc. 32nd Conf. on Decision and Control*, San Antonio, TX, pp. 2050–2055.
- De Callafon, R.A., P.M.J. Van den Hof and D.K. de Vries (1994): "Identification and control of a compact disc mechanism using fractional representations", *Preprints of the 10th IFAC Symposium on System Identification (SYSID)*, Copenhagen, Denmark, pp. 2.121–2.126.
- Defant, A., and K. Floret (1993): *Tensor Norms and Operator Ideals*, North-Holland, Amsterdam, The Netherlands.
- Denham, M.J. (1974): "Canonical forms for the identification of multivariable linear systems", *IEEE Trans. Autom. Contr.*, **Vol. AC-19**, No. 6, pp. 646–656.
- De Vries, D.K. (1994): *Identification of Model Uncertainty for Control Design*, PhD Thesis, Delft University of Technology, the Netherlands.
- El-Sherief, H. and N.K. Sinha (1979): "Determination of the structure of a canonical model for the identification of linear multivariable systems", *Proc. of the 5th Symp. on Identification and System Parameter Estimation*, Darmstadt, FRG, pp. 569–576.
- Falkus, H.M. (1994): *Parametric Uncertainty in System Identification*, PhD Thesis, Eindhoven University of Technology, the Netherlands.
- Faure, P.L. (1976): "Stochastic realization algorithms", in *System Identification: Advances and Case Studies* (R.K. Mehra and D.G. Lainiotis Eds.), Academic Press, New York, pp. 1–26.
- Faure, P., M. Clerget and F. Germain (1979): *Opérateurs Rationnels Positifs — Applications à l'Hyperstabilité et aux Processus Aléatoires*, Dunod, Paris.
- Federov, J.J. (1972): *Theory of Optimal Experiments*, Academic Press, New York.
- Friedlander, B. (1983): "Instrumental Variable methods for ARMA spectral estimation", *IEEE Trans. Acoustics, Speech and Signal Processing*, **Vol. ASSP-31**, No. 2, pp. 404–414.

- Gantmacher, F.G. (1977): *The Theory of Matrices*, Vol. 1, Chelsea Publishing Company, New York, N.Y.
- Gevers, M.R. (1978): "On the identification of feedback systems", *Proc. of the 4th IFAC symposium on Identification and System Parameter Estimation*, Tbilisi, USSR, pp. 1621–1630.
- Gevers, M.R. and B.D.O. Anderson (1981): "Representations of jointly stationary stochastic feedback processes", *Int. J. Control*, **Vol. 33**, No. 5, pp. 777–809.
- Gevers, M.R., and V.J. Wertz (1983): "A d-step predictor in lattice and ladder form", *IEEE Trans. Autom. Contr.*, **Vol. AC-28**, No. 4, pp. 465–476.
- Gevers, M.R. and A.C. Tsoi (1984): "Structural identification of linear multivariable systems using overlapping forms: a new parametrization", *Int. J. Control*, **Vol. 40**, No. 5, pp. 971–987.
- Gevers, M. and V. Wertz (1984): "Uniquely identifiable state-space and ARMA parametrizations for multivariable linear systems", *Automatica*, **Vol. 20**, No. 3, pp. 333–347.
- Gevers, M. and L. Ljung (1986): "Optimal experiment designs with respect to the intended model application", *Automatica*, **Vol. 22**, No. 5, pp. 543–554.
- Gevers, M. (1993): "Towards a joint design of identification and control?", in *Essays on Control: Perspectives in the Theory and its Applications* (H.L. Trentelman and J.C. Willems Eds.), Birkhäuser, Boston, MA, pp. 111–152.
- Glover, K. and J.C. Willems (1974): "Parametrizations of linear dynamical systems: canonical forms and identifiability", *IEEE Trans. Autom. Contr.*, **Vol. AC-19**, No. 6, pp. 640–646.
- Goodwin, G.C., and R.L. Payne (1977): *Dynamic System Identification: Experiment Design and Data Analysis*, Academic Press, New York.
- Goodwin, G.C., and K.S. Sin (1984): *Adaptive Filtering, Prediction and Control*, Prentice-Hall, Englewood Cliffs, NJ.
- Graupe, D. (1975): "On identifying stochastic closed-loop systems", *IEEE Trans. Autom. Contr.*, **Vol. AC-20**, No. 4, pp. 553–555.
- Guidorzi, R.P. (1975): "Canonical structures in the identification of multivariable systems", *Automatica*, **Vol. 11**, pp. 361–374.
- Guidorzi, R.P. (1981): "Invariants and canonical forms for systems structural and parametrical identification", *Automatica*, **Vol. 17**, pp. 117–133.

- Guidorzi, R.P. and S. Beghelli (1982): "Input-output multistructural models in multivariable systems identification", *Proc. of the 6th IFAC Symp. on Identification and System Parameter Estimation*, Washington D.C., USA, pp. 539–543.
- Guidorzi, R.P., M.P. Losito and T. Muratori (1982): "The Range Error Test in the Structural Identification of Linear Multivariable Systems", *IEEE Trans. Autom. Contr.*, **Vol. AC-27**, No. 5, pp. 1044–1053.
- Gustavsson, I., L. Ljung and T. Söderström (1977): "Identification of processes in closed loop — Identifiability and accuracy aspects", *Automatica*, **Vol. 13**, No. 1, pp. 59–75.
- Gustavsson, I., L. Ljung and T. Söderström (1981): "Choice and effect of different feedback configurations", in *Trends and Progress in System Identification* (P. Eykhoff ed.), Pergamon Press, Oxford, pp. 367–388.
- Hakvoort, R.G. (1994): *System Identification for Robust Process Control – Nominal Models and Error Bounds*, PhD Thesis, Delft University of Technology, the Netherlands.
- Hansen, F., G. Franklin and R. Kosut (1989): "Closed-loop identification with the fractional representation: experiment design", *Proc. American Contr. Conf.*, Pittsburgh, PA, pp. 1422–1427.
- Helmicki, A.J., C.A. Jacobson and C.N. Nett (1991): "Control oriented system identification: a worst-case/deterministic approach in  $H_\infty$ ", *IEEE Trans. Autom. Contr.*, **Vol. AC-36**, pp. 1163–1176.
- Heuberger, P. (1991): *On Approximate System Identification with System Based Orthonormal Functions*, PhD Thesis, Delft University of Technology, the Netherlands.
- Heuberger, P.S.C., P.M.J. Van den Hof and O.H. Bosgra (1993): "A generalized orthonormal basis for linear dynamical systems", *Proc. 32nd Conf. on Decision and Control*, San Antonio, TX, pp. 2850–2855.
- Ho, B.L., and R.E. Kalman (1966): "Effective construction of linear state-variable models from input/output functions", *Regelungstechnik*, **Vol. 14**, pp. 545–548.
- Honig, M.L., and D.G. Messerschmitt (1981): "Convergence properties of an adaptive digital lattice filter", *IEEE Trans. Acoustics, Speech and Signal Processing*, **Vol. ASSP-29**, No. 2, pp. 642–653.
- Honig, M.L. (1983): "Convergence models", *IEEE Trans. Acoustics, Speech and Signal Processing*, **Vol. ASSP-31**, No. 2, pp. 415–425.
- Kailath, T. (1980): *Linear Systems*, Prentice Hall, Englewood Cliffs, NJ.

- Lee, D.T.L., M. Morf and B. Friedlander (1981): "Recursive least squares ladder estimation algorithms", *IEEE Trans. Circ. and Syst.*, **Vol. CAS-28**, No. 6, pp. 467–481.
- Lee, D.T.L., B. Friedlander and M. Morf (1982): "Recursive ladder algorithms for ARMA modelling", *IEEE Trans. Autom. Contr.*, **Vol. AC-27**, No. 4, pp. 753–763.
- Lee, W.S., B.D.O. Anderson, R.L. Kosut and I.M.Y. Mareels (1992): "On adaptive robust control and control-relevant system identification", *Proc. Amer. Control Conf.*, Chicago, IL, pp. 2834–2841.
- Lee, W.S., B.D.O. Anderson, R.L. Kosut and I.M.Y. Mareels (1993a): "On robust performance improvement through the windsurfer approach to adaptive robust control", *Proc. of the 32nd Conf. on Decision and Control*, San Antonio, TX, pp. 2821–2827.
- Lee, W.S., B.D.O. Anderson, R.L. Kosut and I.M.Y. Mareels (1993b): "A new approach to adaptive robust control", *Int. J. Adaptive Control and Signal Processing*, **Vol. 7**, pp. 183–211.
- Lee, W.S., B.D.O. Anderson, I.M.Y. Mareels and R.L. Kosut (1994): "On some practical issues in system identification for the windsurfer approach to adaptive robust control", *Preprints of the 10th IFAC Symposium on System Identification (SYSID)*, Copenhagen, Denmark, pp. 2.165–2.170.
- Levinson, N. (1947): "The Wiener rms (root mean square) error criterion – filter design and prediction", *J. Math. Phys.*, **Vol. 25**, pp. 261–278.
- Levy, E.C. (1959): "Complex curve fitting", *IRE Trans. Autom. Contr.*, **Vol. AC-4**, pp. 37–44.
- Lewis, F.L. (1986): *Optimal Control*, John Wiley & Sons, New York.
- Lindquist, A. and G. Picci (1979): "On the stochastic realization problem", *SIAM J. Control and Optimization*, **Vol. 17**, No. 3, pp. 365–389.
- Lindquist, A. and M. Pavon (1984): "On the structure of state-space models for discrete-time stochastic vector processes", *IEEE Trans. Autom. Contr.*, **Vol. AC-29**, No. 5, pp. 418–432.
- Lindquist, A. and G. Picci (1985): "Realization theory for multivariate stationary Gaussian processes", *SIAM J. Control and Optimization*, **Vol. 23**, No. 6, pp. 809–857.
- Ljung, L., I. Gustavsson and T. Söderström (1974): "Identification of linear multivariable systems operating under linear feedback control", *IEEE Trans. Autom. Contr.*, **Vol. AC-19**, No. 6, pp. 836–840.

- Ljung, L., and T. Söderström (1983): *Theory and Practice of Recursive Identification*, The MIT Press, Cambridge, MA.
- Ljung, L. (1985): "Asymptotic variance expressions for identified black box transfer function models", *IEEE Trans. Autom. Contr.*, **Vol. AC-30**, pp. 834–844.
- Ljung, L. (1987): *System Identification: Theory for the User*, Prentice-Hall, Englewood Cliffs, NJ.
- Ljung, L. (1991): *System Identification Toolbox – User's Guide*, For use with Matlab.
- Ljung, L. (1993): "Information contents in identification data from closed-loop operation", *Proc. of the 32nd Conf. on Decision and Control*, San Antonio, TX, pp. 2248–2252.
- Makhoul, J.I. (1977): "Stable and efficient lattice methods for linear prediction", *IEEE Trans. Acoustics, Speech and Signal Processing*, **Vol. ASSP-25**, No. 5, pp. 423–428.
- Mehra, R.K. (1974): "Optimal input signals for parameter estimation in dynamic systems, survey and new results", *IEEE Trans. Autom. Contr.*, **Vol. AC-19**, No. 6, pp. 753–768.
- Mehra, R.K. (1981): "Choice of input signals", in *Trends and Progress in System Identification* (P. Eykhoff, Ed.), Pergamon Press, Oxford, pp. 305–366.
- Moonen, M., B. De Moor, L. Vandenberghe and J. Vandewalle (1989): "On- and off-line identification of linear state-space models", *Int. J. Control*, **Vol. 49**, No. 1, pp. 219–232.
- Moonen, M. and J. Vandewalle (1990): "QSVD approach to on- and off-line state-space identification", *Int. J. Control*, **Vol. 51**, No. 5, pp. 1133–1146.
- Morari, M. and E. Zafiriou (1989): *Robust Process Control*, Prentice-Hall, Englewood Cliffs, NJ.
- Morf, M., A. Vieira and D.T.L. Lee (1977): "Ladder forms for identification and speech processing", *Proc. 16th IEEE Conf. on Decision and Control*, New Orleans, LA, pp. 1074–1078.
- Morf, M., D.T.L. Lee, D. Nickolls and A. Vieira (1978): "A classification of algorithms for ARMA models and ladder realizations", *IEEE Conf. on Acoustics, Speech and Signal Processing*, Hartford, CT, pp. 13–19.
- Morf, M., and D.T.L. Lee (1979): "Recursive least squares ladder forms for fast parameter tracking", *Proc. 18th IEEE Conf. on Decision and Control*, San Diego, CA, pp. 1362–1367.
- Ng, T.S., G.C. Goodwin and B.D.O. Anderson (1977): "Identifiability of MIMO linear dynamic systems operating in closed loop", *Automatica*, **Vol. 13**, No. pp. 477–485.

- Nisenfeld, A.E. and R.C. Seeman (1981): *Distillation Columns*, Instrument Society of America Monograph, Research Triangle Park, NC.
- Ölcer, S. (1984): "Convergence analysis of ladder algorithms for AR and ARMA models", *Proc. of the 23rd Conf. on Decision and Control*, Las Vegas, NV.
- Pappas, T., A.J. Laub and N.R. Sandell (1980): "On the numerical solution of the discrete-time algebraic Riccati equation", *IEEE Trans. Autom. Contr.*, Vol. AC-25, No. 4, pp. 631-641.
- Partanen, A.G. and R.R. Bitmead (1993): "Two stage iterative identification/controller design and direct experimental controller refinement", *Proc. 32nd Conf. on Decision and Control*, San Antonio, TX, pp. 2833-2838.
- Partanen, A.G., Z. Zang, R.R. Bitmead and M. Gevers (1994): "Experimental restricted complexity controller design", *Preprints of the 10th IFAC Symposium on System Identification (SYSID)*, Copenhagen, Denmark, pp. 2.177-2.182.
- Pavon, M. (1980): "Stochastic realization and invariant directions of the matrix Riccati equation", *SIAM J. Control and Optimization*, Vol. 18, No. 2, pp. 155-180.
- Polat, A. (1992): *Lattice Filters in Identification*, MSc Thesis, A92.016(600), Control Laboratory, Dept. of EE, Delft University of Technology, the Netherlands.
- Priestley, M.B. (1981): *Spectral Analysis and Time Series*, Academic Press, London.
- Richalet, J. (1991): *Pratique de l'Identification*, Editions Hermès, Paris, France.
- Richalet, J., S. Abu el Ata-Doss and A. Coic (1991): "Global identification and optimal input design", *IFAC preprints 9th IFAC/IFORS symp.*, Budapest, pp. 809-814.
- Sanathanan, C.K. and J. Koerner (1963): "Transfer function synthesis as a ratio of two complex polynomials", *IEEE Trans. Autom. Contr.*, Vol. AC-8, pp. 56-58.
- Sargent, R.G. (1988): "A tutorial on validation and verification of simulation models", *Proc. of the 1988 Winter Simulation Conference*.
- Schinkel, S. (1993): *Model Validation with Invalidation Techniques*, Internal Report T93.001, Control Laboratory, Dept. of EE, Delft University of Technology, the Netherlands.
- Schinkel, S. (1994): *Optimal Input Design for Frequency-Function Variance Reduction: an Optimization Problem*, MSc Thesis, A94.042(664), Control Laboratory, Dept. of EE, Delft University of Technology, the Netherlands.

- Schoukens, J. and R. Pintelon (1991): *Identification of Linear Systems – a Practical Guideline to Accurate Modeling*, Pergamon Press, Oxford.
- Schrama, R.J.P. (1992a): *Approximate Identification and Control Design, with Application to a Mechanical System*, PhD Thesis, Delft University of Technology, the Netherlands.
- Schrama, R.J.P. (1992b): "Accurate identification for control: the necessity of an iterative scheme", *IEEE Trans. Autom. Contr.*, **Vol. 37**, No. 7, pp. 991–994.
- Shinsky, F.G. (1984): *Distillation Control for Productivity and Energy Conservation*, McGraw-Hill, New York.
- Shook, D.S., C. Mohtadi and S.L. Shah (1992): "A control-relevant identification strategy for GPC", *IEEE Trans. Autom. Contr.*, **Vol. 37**, No. 7, pp. 975–980.
- Sin, K.S. and G.C. Goodwin (1980): "Checkable conditions for identifiability of linear systems operating in closed loop", *IEEE Trans. Autom. Contr.*, **Vol. AC-25**, No. 4, pp. 722–729.
- Smith, R.S. (1989): *Model Validation for Uncertain Systems*, PhD Thesis, California Institute of Technology, Pasadena, CA, USA.
- Söderström, T., L. Ljung and I. Gustavsson (1974): *On the Accuracy of Identification and the Design of Identification Experiments*, Report 7428, Dept. of Automatic Control, Lund Institute of Technology, Lund, Sweden.
- Söderström, T., I. Gustavsson and L. Ljung (1975): "Identifiability conditions for linear systems operating in closed loop", *Int. J. Control*, **Vol. 21**, No. 2, pp. 243–255.
- Söderström, T. and P. Stoica (1981): "Comparison of some instrumental variable methods – consistency and accuracy aspects", *Automatica*, **Vol. 17**, pp. 101–115.
- Söderström, T. and P.G. Stoica (1983): *Instrumental Variable Methods for System Identification*, Lecture notes in Control and Information Sciences (A.V. Balakrishnan and M. Thoma, eds.), Springer-Verlag, Berlin.
- Söderström, T., P. Stoica and E. Trulsson (1987): "Instrumental variable methods for closed loop systems", *Prepr. of the 10th IFAC World Congress on Automatic Control*, **Vol. 10**, Munich, FRG, pp. 364–369.
- Söderström, T. and P.G. Stoica (1989): *System Identification*, Prentice-Hall, Englewood Cliffs, NJ.
- Tulleken, H.J.A.F. (1990): "Generalized Binary Noise Test-signal concept for improved Identification-Experiment Design", *Automatica*, **Vol. 26**, No. 1, pp. 37–49.

- Tulleken, H.J.A.F. (1992): *Grey-box Modelling and Identification Topics*, PhD Thesis, Delft University of Technology, the Netherlands.
- Van den Bosch, P.P.J. and A.C. van der Klauw (1994): *Modeling, Identification and Simulation of Dynamical Systems*, CRC Press, Boca Raton, FL.
- Van den Hof, P.M.J. and P. Janssen (1987): "Some asymptotic properties of multivariable models identified by equation error techniques", *IEEE Trans. Autom. Contr.*, **Vol. AC-32**, No. 1, pp. 89–92.
- Van den Hof, P.M.J., D.K. De Vries and P. Schoen (1992): "Delay structure conditions for identifiability of closed loop systems", *Automatica*, **Vol. 28**, pp. 1047–1050.
- Van den Hof, P.M.J., R.J.P. Schrama and O.H. Bosgra (1992): "An indirect method for transfer function estimation from closed loop data", *Proc. of the 31st IEEE Conf. on Decision and Control*, Tucson, Arizona, USA, pp. 1702–1706.
- Van den Hof, P.M.J. and R.J.P. Schrama (1993): "An indirect method for transfer function estimation from closed loop data", *Automatica*, **Vol. 29**, pp. 1523–1527.
- Van den Hof, P.M.J., R.J.P. Schrama, O.H. Bosgra and R.A. de Callafon (1993): "Identification of normalized coprime plant factors for iterative model and controller enhancement", *Proc. 32nd Conf. on Decision and Control*, San Antonio, TX, pp. 2839–2844.
- Van den Hof, P.M.J., and R.J.P. Schrama (1994): "Identification and control – closed loop issues", *Preprints of the 10th IFAC Symposium on System Identification (SYSID)*, Copenhagen, Denmark, pp. 2.1–2.13.
- Van den Hof, P.M.J., P.S.C. Heuberger and J. Bokor (1994): "Identification with generalized orthonormal basis functions – statistical analysis and error bounds", *Preprints of the 10th IFAC Symposium on System Identification (SYSID)*, Copenhagen, Denmark, pp. 3.207–3.212.
- Van der Klauw, A.C., M. Verhaegen and P.P.J. Van den Bosch (1991): "State space Identification of Closed Loop Systems", *Proc. IEEE Conference on Decision and Control*, Brighton, UK, pp. 1327–1332.
- Van der Klauw, A.C., A. Polat and P.P.J. van den Bosch (1993): "Lattice algorithms for recursive ARMAX identification", *Proc. of the 1993 American Control Conference*, San Francisco, USA, pp. 2011–2013.
- Van der Klauw, A.C. and P.P.J. van den Bosch (1993): "A model structure selection procedure for multivariable systems identification", *Proc. of the 1993 European Control Conference*, Groningen, The Netherlands, pp. 1319–1324.



- Van der Klauw, A.C., A. Polat and P.P.J. van den Bosch (1994a): "Lattice algorithms for recursive identification of general model structures", *Proc. of the 1994 American Control Conference*, Baltimore, ML, USA, pp. 520–524.
- Van der Klauw, A.C., J.E.F. van Osch and P.P.J. van den Bosch (1994b): "Closed-loop identification methods for LQ control design", *Preprints of the 10th IFAC Symposium on System Identification (SYSID)*, Copenhagen, Denmark, pp. 3.609–3.613.
- Van der Klauw, A.C., G.J.P. de Reuver and P.P.J. van den Bosch (1994c): "Optimal input design based on global identification", *Preprints of the 10th IFAC Symposium on System Identification (SYSID)*, Copenhagen, Denmark, pp. 3.525–3.530.
- Van der Klauw, A.C., G.E. van Ingen, A. van Rhijn, S. Olivier, P.P.J. van den Bosch and R.A. de Callafon (1994d): "Closed-loop identification of a distillation column", *Proc. of the third IEEE Conference on Control Applications*, Glasgow, UK, pp. 275–280.
- Van der Schaft, A.J. and J.C. Willems (1984): "A new procedure for stochastic realization of spectral density matrices", *SIAM J. Control and Optimization*, **Vol. 22**, No. 6, pp. 845–855.
- Van Dooren, P. (1981): "A generalized eigenvalue approach for solving Riccati equations", *SIAM J. Control and Optimization*, **Vol. 2**, No. 2, pp. 121–135.
- Van Osch, J.E.F. (1992): *Identification of Multivariable Processes Operating under Feedback*, MSc Thesis, A92.053(615), Control Laboratory, Dept. of EE, Delft University of Technology, the Netherlands.
- Van Overbeek, A.J.M. and L. Ljung (1982): "On-line structure selection for multivariable state-space models", *Automatica*, **Vol. 18**, No. 5, pp. 529–543.
- Van Overschee, P. and B. De Moor (1991): "Subspace algorithms for the stochastic identification problem", *Proc. of the 30th Conf. on Decision and Control*, Brighton, UK, pp. 1321–1326.
- Van Overschee, P. and B. De Moor (1993): "Subspace algorithms for the stochastic identification problem", *Automatica*, **Vol. 29**, No. 3, pp. 649–660.
- Van Overschee, P. and B. De Moor (1994a): "N4SID: two subspace algorithms for identification of combined deterministic-stochastic systems", *Automatica*, **Vol. 30**, No. 1, pp. 75–93.
- Van Overschee, P. and B. De Moor (1994b): "A unifying theorem for subspace identification algorithms and its interpretation", *Preprints of the 10th IFAC Symposium on System Identification (SYSID)*, Copenhagen, Denmark, pp. 2.145–2.150.

- Verhaegen, M. and P. Dewilde (1992a): "Subspace Model Identification, Part 1: the Output-Error State Space Model Identification class of algorithms", *Int. J. Control*, **Vol. 56**, No. 5, pp. 1187–1210.
- Verhaegen, M. and P. Dewilde (1992b): "Subspace Model Identification, Part 2: Analysis of the elementary Output-Error State Space Model Identification algorithm", *Int. J. Control*, **Vol. 56**, No. 5, pp. 1211–1241.
- Wahlberg, B. and L. Ljung (1986): "Design variables for bias distribution in transfer function estimation", *IEEE Trans. Autom. Contr.*, **Vol. AC-32**, pp. 134–144.
- Wahlberg, B. (1991): "System identification using Laguerre models", *IEEE Trans. Autom. Contr.*, **Vol. AC-36**, pp. 551–562.
- Wahlberg, B. (1994): "System identification using Kautz models", *IEEE Trans. Autom. Contr.*, **Vol. AC-39**, No. 6, pp. 1276–1282.
- Wellstead, P.E. (1978): "The identification and parameter estimation of feedback systems", *Proc. of the 4th IFAC Symposium on identification and system parameter estimation*, Tbilisi, USSR, pp. 1593–1600.
- Yang, Y.P. and K.M. Huang (1992): "Adaptive lattice estimation and control of a manipulator with one flexible forearm", *IEE Proceedings-D*, **Vol. 139**, No. 3, pp. 237–244.
- Yuan, Z.D. and L. Ljung (1984): "Black-box identification of multivariable transfer functions — asymptotic properties and optimal input design", *Int. J. Control*, **Vol. 40**, No. 2, pp. 233–256.
- Zang, Z., R.R. Bitmead and M. Gevers (1991): *Iterative Model Refinement and Control Robustness Enhancement*, Report no. 91.137, Center for Systems Eng. and Appl. Mech., Univ. Cath. de Louvain-La-Neuve, Belgium.
- Zarrop, M.B. (1979): "Optimal experiment design for dynamic system identification", *Lect. Not. in Contr. and Inf. Sciences*, **Vol. 21**, Springer Verlag, Berlin.
- Zheng, W. and C. Feng (1991): "A new look at least-squares identification of closed-loop systems", *Preprints of the 9th IFAC/IFORS Symp. on Identification and System Parameter Estimation*, Budapest, Hungary, pp. 1374–1378.
- Zhu, Y.C. (1990): *Identification and Control of MIMO Industrial Processes: An Integration Approach*, PhD Thesis, Eindhoven University of Technology, the Netherlands.
- Zhu, Y.C. and Backx, T. (1993): *Identification of Multivariable Industrial Processes for Simulation, Diagnosis and Control*, Springer Verlag, London.

---

## *List of symbols and abbreviations*

This list summarizes the operators, variables and abbreviations that are used throughout the thesis. The variables are divided into time-dependent variables and other variables.

### *Matrix operators and notational conventions*

A hat  $\hat{\cdot}$  over a variable indicates that it is estimated from data. An asterisk  $*$  indicates that the variable is optimal in some sense, or it denotes the complex conjugate. This will be clear from the context.

Other definitions and matrix operators are ( $A$  is an arbitrary matrix)

|                    |  |
|--------------------|--|
| $A'$               | transpose of matrix $A$                        |
| $A^*$              | conjugated transpose of the complex matrix $A$ |
| $A^{-1}$           | inverse of matrix $A$                          |
| $\text{tr}\{A\}$   | trace of matrix $A$                            |
| $\det\{A\}$        | determinant of matrix $A$                      |
| $\text{im}\{A\}$   | image of $A$                                   |
| $\text{rank}\{A\}$ | rank of matrix $A$                             |
| $\text{Im}\{A\}$   | imaginary part of $A$                          |
| $\text{Re}\{A\}$   | real part of $A$                               |
| $\ A\ _2$          | two-norm of $A$                                |
| $V_x$              | $\partial V / \partial x$                      |
| $V_{x,x}$          | $\partial^2 V / \partial x^2$                  |

### *Time-dependent variables*

The following symbols represent variables that depend on time  $t$ . This is denoted by the subscript  $t$ . If a time-vector is  $x_t$ , then the associated signal is  $\{x_t\}$ .

|                  |   |
|------------------|---|
| $F_{i,t}$        | cross-covariance matrix between backward residual and forward prediction errors                     |
| $K_{i,t}^e$      | forward reflection coefficient  |
| $K_{i,t}^r$      | backward reflection coefficient   |
| $R_{i,t}$        | covariance matrix of order $i$  |
| $R_{i,t}^e$      | cross-covariance matrix of forward residual and prediction errors                                   |
| $R_{i,t}^r$      | cross-covariance matrix of backward residual and prediction errors                                  |
| $e_t$            | zero mean white noise   |
| $e_{i,t}$        | forward prediction error  |
| $\bar{e}_{i,t}$  | forward residual error  |
| $r_{1,t}$        | reference signal  |
| $r_{2,t}$        | external excitation signal  |
| $r_t$            | external input signal: $r_t = C_f r_{1,t} + r_{2,t}$  |
| $r_{i,t}$        | backward prediction error   |
| $\bar{r}_{i,t}$  | backward residual error   |
| $r_{\text{bq}}$  | reference value for the bottom quality  |
| $r_{\text{tq}}$  | reference value for the top quality   |
| $u_t$            | process input   |
| $u_t^r$          | part of $u_t$ that stems from $r_t$ only  |
| $u_{\text{cp}}$  | set point of the cutpoint temperature controller  |
| $u_{\text{irf}}$ | set point of the internal reflux-to-feed ratio controller   |
| $v_t$            | additive output disturbance   |
| $v_{0,t}$        | true additive output disturbance  |
| $w_t$            | noise-free output   |
| $x_t$            | state vector  |
| $x_{\text{cp}}$  | measured cutpoint temperature   |
| $x_{\text{irf}}$ | measured internal reflux-to-feed ratio  |
| $y_t$            | process output  |
| $y_t^r$          | part of $y_t$ that stems from $r_t$ only  |
| $y_{\text{bq}}$  | quality (impurity) of the bottom product  |
| $y_{\text{tq}}$  | quality (impurity) of the top product   |
| $z_t$            | joint process input and output: $z_t = (y_t' \ u_t')'$<br>or data vector (recursive identification) |
| $\tilde{z}_t$    | filtered data vector  |
| $\Theta_{i,t}^e$ | forward model   |
| $\Theta_{i,t}^r$ | backward model  |
| $\beta_{i,t}$    | parameter relating the residual and prediction errors   |
| $\varepsilon_t$  | prediction error  |

|                          |   |
|--------------------------|---|
| $\bar{\varepsilon}_t$    | residual error                                |
| $\zeta_t$                | instrumental variable                         |
| $\eta_t$                 | external excitation signal                    |
| $\hat{\theta}_t$         | parameter estimate (recursive identification) |
| $\vartheta_{i,t}$        | lattice parameter vector                      |
| $\phi_t$                 | regression vector                             |
| $\varphi_{i,t}$          | lattice regressor                             |
| $\chi_{y,t}, \chi_{u,t}$ | fictitious white noise inputs                 |
| $\psi_t$                 | gradient vector                               |

### Other variables

|                          |  |
|--------------------------|--|
| $A, B, C, D, F$          | polynomials or polynomial matrices of a general model  |
| $A, B, C$                | state space matrices   |
| $\mathbb{C}$             | set of complex numbers   |
| $C_b$                    | feedback part of the controller  |
| $C_f$                    | feedforward part of the controller   |
| $C$                      | controller = $(C_f, C_b)$  |
| $\mathbb{E}$             | mathematical expectation   |
| $\bar{\mathbb{E}}$       | generalized expectation $\bar{\mathbb{E}}\{x_t\} = \lim_{N \rightarrow \infty} \frac{1}{N} \sum_{t=1}^N \mathbb{E}\{x_t\}$ |
| $F_u$                    | local input filter for LQ controller design  |
| $F_y$                    | local output filter for LQ controller design   |
| $G_0$                    | true process   |
| $\hat{G}$                | model of $G_0 = G(\hat{\theta})$   |
| $G_c$                    | closed-loop input-output process   |
| $\mathcal{G}$            | set of input-output models $\{G(z, \theta)   \theta \in \Theta\}$  |
| $H_0$                    | true noise process   |
| $\hat{H}$                | model of $H_0$   |
| $\hat{H}_c$              | closed-loop noise process  |
| $H_j, j = 1, 2, \dots$   | Markov parameters  |
| $H_{ur}$                 | system between $r$ and $u$   |
| $H_{yr}$                 | system between $r$ and $y$   |
| $\mathcal{H}_{N,\infty}$ | Hankel matrix of Markov parameters   |
| $I_n$                    | $n \times n$ identity matrix   |
| $\mathcal{I}$            | multi-index  |
| $J_C$                    | control design criterion   |
| $J_I$                    | identification criterion   |
| $K_0$                    | shaping filter for $r_t$   |

|                           |  |
|---------------------------|--|
| $K_r$                     | tensor of polynomials relating $r_t$ and the instrumental variables                |
| $K_u$                     | $p \times d \times m$ tensor of transfer functions                                 |
| $L$                       | prediction error prefilter   |
| $L_u$                     | identification filter for the input  |
| $L_y$                     | identification filter for the output   |
| $\mathcal{M}$             | model set $\{(G(z, \theta), H(z, \theta))   \theta \in \Theta\}$                   |
| $N$                       | number of samples; length of data set  |
| $\mathbb{N}$              | set of natural numbers $\{0, 1, 2, \dots\}$  |
| $Q$                       | positive definite matrix   |
| $\mathbb{R}$              | set of real numbers  |
| $\mathbb{R}(z)$           | field of rational functions of $z$ with real coefficients                          |
| $\mathbb{R}[z]$           | ring of polynomials in $z$ with real coefficients                                  |
| $S_0^{(o)}$               | output sensitivity function  |
| $S_0^{(i)}$               | input sensitivity function   |
| $S$                       | true system $(G_0(z), H_0(z))$   |
| $T$                       | transformation matrix  |
| $T_b$                     | basic switching time of GBN  |
| $T_{sw}$                  | switching time of GBN  |
| $W$                       | weighting matrix for input design  |
| $W_0$                     | true system between white noise inputs and joint process input and output          |
| $\mathbb{Z}$              | set of integers $\{\dots, -2, -1, 0, 1, 2, \dots\}$                                |
| $a_j, b_j, c_j, d_j, f_j$ | parameters of $A, B, C, D, F$  |
| $d$                       | number of parameters ( $= \dim \theta$ )   |
| $f_I$                     | IV function  |
| $i$                       | imaginary number: $i^2 = -1$   |
| $m$                       | number of process inputs   |
| $n$                       | dimension of the state vector  |
| $p$                       | number of process outputs  |
| $q$                       | nonswitching probability of GBN  |
| $q$                       | forward shift operator   |
|                           | $= 2p - 1$ for GBN   |
| $q^{-1}$                  | backward shift operator  |
| $r_j, j = 1, \dots, p$    | structure indices  |
| $s$                       | model structure  |
| $t$                       | time index of a discrete signal  |
| $z$                       | complex number   |
| $\Gamma(\omega)$          | $(\operatorname{Re}\{G(e^{i\omega})\} \quad \operatorname{Im}\{G(e^{i\omega})\})'$ |
| $\Delta_{ij}$             | unit pulse   |

|                 |   |
|-----------------|---|
| $\Theta$        | set of permitted parameter vectors: parameter space                                       |
| $\Xi(\omega)$   | $(\operatorname{Re}\{GS(e^{i\omega})\} \operatorname{Im}\{GS(e^{i\omega})\})'$            |
| $\Pi$           | parametrization   |
| $\Phi_u$        | (auto)spectrum of the signal $u$  |
| $\Phi_{yu}$     | cross spectrum of $y$ and $u$   |
| $\Psi(\omega)$  | $(\operatorname{Re}\{S(e^{i\omega})\} \operatorname{Im}\{S(e^{i\omega})\})'$              |
| $\alpha$        | number of polynomials in a model structure, or<br>parameter vector                        |
| $\beta$         | parameter vector  |
| $\beta_\infty$  | asymptotic estimate of $\beta$  |
| $\gamma$        | parameter vector in the frequency domain containing elements of the<br>frequency function |
| $\theta$        | parameter vector  |
| $\theta_0$      | true parameter, or initial estimate   |
| $\theta_\infty$ | asymptotic estimate of $\theta$   |
| $\lambda$       | LQ input power weighting, $\lambda$<br>forgetting factor (recursive identification)       |
| $\xi$           | input protocol  |
| $\tau$          | time lag  |
| $\omega$        | radial frequency  |

## Abbreviations

|       |   |
|-------|---|
| ARMAX | Auto-Regressive Moving Average with eXogenous input |
| ARX   | Auto-Regressive with eXogenous input                |
| BIBO  | Bounded Input Bounded Output                        |
| BJ    | Box-Jenkins   |
| DI    | Direct Identification method                        |
| FIR   | Finite Impulse Response                             |
| GBN   | Generalized Binary Noise                            |
| GI    | Generalized closed-loop Identification method       |
| II    | Indirect Identification method                      |
| IMC   | Internal Model Control                              |
| IV    | Instrumental Variable method                        |
| JIO   | Joint Input/Output method                           |
| LELS  | Lattice Extended Least Squares                      |
| LIV   | Lattice Instrumental Variable                       |
| LLS   | Linear Least Squares                                |

---

|           |  |
|-----------|--|
| LOE       | Lattice Output Error                       |
| LPEM      | Lattice Prediction Error Method            |
| LPLR      | Lattice Pseudo-Linear Regression           |
| LQ        | Linear Quadratic                           |
| LTI       | Linear, Time-Invariant                     |
| LTIFD     | Linear, Time-Invariant, Finite-Dimensional |
| MFD       | Matrix Fraction Description                |
| MIMO      | Multi-Input Multi-Output                   |
| MISO      | Multi-Input Single-Output                  |
| OE        | Output Error                               |
| ORTFIR    | ORTHogonal FIR                             |
| PEM       | Prediction Error Method                    |
| PID       | Proportional Integral Differential         |
| PRBS      | Pseudo-Random Binary Sequence              |
| RELS      | Recursive Extended Least Squares           |
| RPEM      | Recursive Prediction Error Method          |
| ROE       | Recursive Output Error                     |
| RPLR      | Recursive Pseudo-Linear Regression         |
| SISO      | Single-Input Single-Output                 |
| SMI       | Subspace Model Identification              |
| S/N-ratio | Signal to Noise ratio                      |
| TS        | Two-Step method                            |
| ZMWN      | Zero Mean White Noise                      |
| w.p. 1    | with probability one                       |



---

## *Gesloten-lus identificatie onderwerpen in de procesindustrie*

Het ontwerpen van regelingen in de procesindustrie impliceert vaak het ontwerpen van model-gebaseerde regelaars. Om een voldoende prestatie te halen, uitgedrukt in bijvoorbeeld de kwaliteit van de uitgang en het energieverbruik, worden regelaars ontworpen die zijn gebaseerd op modellen van het te regelen proces.

Deze modellen zijn in het algemeen wiskundige black-box modellen. Dit betekent dat er geen fysieke interpretatie is van de structuur en van de parameters van het model. De modellen worden verkregen uit metingen van procesingangen en -uitgangen, met een identificatie methode, zoals de Prediction Error Method (PEM), die een functie van het verschil tussen model- en procesuitgang minimaliseert. Om voldoende informatie over de procesdynamica te verkrijgen, dient hetingangssignaal zodanig te worden ontworpen dat het proces voldoende wordt geëxciteerd.

In de standaard PEM aanpak wordt aangenomen dat hetingangssignaal vrij kan worden gekozen door de gebruiker, zodat het ongecorrleerd is met de verstoringen die op het proces inwerken. Dit houdt in dat het identificatie experiment waarmee de data wordt verkregen, moet worden uitgevoerd in een open-lus situatie (met de regelaar uitgeschakeld). In de procesindustrie daarentegen is het in het algemeen niet mogelijk om een open-lus experiment uit te voeren, en het moet dus in gesloten lus worden gedaan. De regelaar moet actief blijven gedurende de meeste experimenten om de veiligheid te garanderen van het proces, de operators en de omgeving. Bovendien zou een open-lus experiment duur zijn, omdat het ongeregelde proces wordt geëxciteerd door een of anderingangssignaal, waardoor de produktiekwaliteit afneemt.

In dit proefschrift wordt onderzocht of een model kan worden geïdentificeerd uit gesloten-lus data, zodanig dat een (opnieuw) ontworpen regelaar een hogere prestatie van het gesloten-lus systeem tot gevolg heeft. Als het doel van de identificatie – het ontwerpen of verbeteren van regelaars – en het toepassingsgebied – de procesindustrie – met haar specifieke eigenschappen in ogenschouw worden genomen, kunnen verschillende onderwerpen worden onderscheiden, die aan het gestelde probleem zijn gerelateerd.

Het eerste onderwerp is gesloten-lus identificatie. Dit heeft te maken met het probleem hoe een model kan worden verkregen met gesloten-lus data. Een overzicht van bestaande gesloten-lus identificatie methoden is gegeven, en een unificerende methode wordt gepresenteerd die de methoden generaliseert die zijn gebaseerd op de Prediction Error Method. De voorgestelde Gegeneraliseerde Identificatie methode kan consistente modellen leveren, als de modelverzameling ruim genoeg is om het proces volledig te bevatten. Deze situatie komt in de praktijk niet voor, en er zal altijd een bias (modelfout) zijn. De Gegeneraliseerde Identificatie kan de verdeling van de bias over het frequentiedomein expliciet beïnvloeden door geschikte filters toe te passen op de ingangs-uitgangs data. Dit stelt de gebruiker in staat om de bias aan te passen aan specificaties van de latere regelaarontwerpstep, zoals bijvoorbeeld een kleine bias in de omgeving van de gewenste gesloten-lus bandbreedte.

Het tweede punt dat wordt besproken is het parametrisatieprobleem. De parametrisatie of modelstructuur van een black-box model is willekeurig, maar het bepaalt wel de conditionering van het parameterschattingsprobleem, en daarmee de resultaten van de identificatie methode.

Enkele bekende resultaten met betrekking tot het schatten van dode tijd en parametrisaties met orthonormale basisfuncties worden besproken, en een algoritme om een geschikte modelstructuur voor multivariabele systemen te kiezen wordt voorgesteld.

Een herparametrisatie van Single-Input Single-Output (SISO) modellen resulteert in een orthogonale basis in de regressor ruimte. Dit resultaat is al gebruikt in on-line ladder identificatie algoritmen voor lineaire parametrisaties. Deze algoritmen worden uitgebreid om ook te gelden voor meer algemene parametrisaties. De voorgestelde ladder algoritmen hebben dezelfde voordelen als de bestaande ladder algoritmen. Modellen van verschillende ordes worden tegelijkertijd geschat en de algoritmen hebben minder berekeningen nodig dan niet-ladder implementaties.

Het derde onderwerp dat aan de orde komt betreft regelaar-relevante identificatie. In aanmerking nemend dat het doel van de identificatie is om een model te leveren, dat geschikt is voor regelaarontwerp, hoe kan dit worden meegenomen in de identificatie procedure?

Dit onderzoeksgebied is recentelijk opgekomen, en verschillende iteratieve schema's van identificatie en regelaarontwerp zijn in de literatuur voorgesteld. Deze schema's hebben gemeen dat een model wordt geïdentificeerd uit gesloten-lus data, vervolgens wordt een model-gebaseerde regelaar ontworpen, en toegepast om de behaalde prestatie te evalueren. Indien die niet toereikend is, wordt een nieuwe iteratie gestart.

Om het aantal iteraties te reduceren, en daarmee het aantal experimenten dat moet worden uitgevoerd, wordt een extra iteratieve lus toegevoegd aan de bestaande schema's. In deze lus wordt een nieuw model geschat uit dezelfde data als het vorige model, maar met andere filters, die afhangen van de ontworpen regelaar. Deze filters bepalen de bias van het model, en de bias kan dus zo worden gevormd dat een betere regelaar resulteert. Een

mogelijke keuze voor filters in een iteratief schema van gesloten-lus identificatie en LQ regelaar ontwerp wordt voorgesteld, en geschikte stopcriteria worden geïntroduceerd om te beslissen wanneer de iteraties te beëindigen.

Het vierde probleem dat wordt beschouwd is het ontwerp van een ingangssignaal. De bias van een model wordt bepaald door geschikte filters toe te passen op de gemeten data. De variantie van een model wordt gereduceerd door een geschikt ingangssignaal toe te passen.

De gevolgde aanpak gaat uit van de relatie tussen de variantie van een model en de Hessiaan van het PEM identificatie criterium. Scalaire functies van de Hessiaan naar de modelparameters worden gebruikt om een excitatie signaal te ontwerpen.

Gezien vanuit regelaarontwerp is de onzekerheid van de frequentieresponsie meer geschikt om de kwaliteit van een model te evalueren, dan de onzekerheid van de modelparameters. Regelaareigenschappen, zoals robuustheid, worden meestal in het frequentiedomein gespecificeerd, en daarom lijkt het relevanter om te proberen de variantie van de frequentieresponsie te reduceren of te beïnvloeden. Deze aanpak resulteert in een nieuwe optimaal ingangssignaal ontwerp methode, die is gebaseerd op de Hessiaan van het identificatiecriterium naar punten van de frequentieresponsie. Deze methode is ontwikkeld voor zowel open-lus als gesloten-lus identificatie.

De precieze locatie van het ingangssignaal in de gesloten lus blijkt geen invloed te hebben op de identificatie resultaten, en kan daarom worden gekozen in overeenstemming met de eisen en beperkingen van het proces.

Als laatste is een industrieel experiment uitgevoerd. Een excitatiesignaal is toegepast op een multivariabele destillatiekolom in een gesloten lus, en de resulterende data is gebruikt om modellen te identificeren. Vanwege de korte lengte van de dataset in vergelijking tot het grote aantal modelparameters kunnen de resultaten niet worden geverifieerd met behulp van kruisvalidatie. Suggesties worden gegeven ter verbetering van de betrouwbaarheid van de resultaten van toekomstige identificatie experimenten.



---

## *Acknowledgements*

The completion of a PhD thesis gives an ethereal feeling. Four years of research have been summarized in a 200-page manuscript, which is finally ready. A feeling of pride cannot be suppressed. I thank the Dutch Technology Foundation (STW) for financing this research, and offering me the possibility to work on such an interesting project.

Reviewing the four years I spent at the Control Laboratory, Department of Electrical Engineering, Delft University of Technology, I remember it as a period of creating and taking opportunities, and continuous learning.

I have learned a great deal from my promotor, Prof. dr. ir. Paul van den Bosch. Both on a professional and on a social level we have had many interesting discussions. He was there to give advice or backup, to motivate me, or to bring me down to earth. He never hesitated to ask my advice either, and I think that this mutual respect has been inspiring for both of us. I want to thank him for everything he did during my four-year stay.

My copromotor, Dr. ir. Paul Van den Hof, deserves special thanks for the time he spent on my thesis, and for the ideas he brought forward. The discussions we had were open, and very often they resulted in the solution of the problems I had put forward. The second thoughts he sometimes had with respect to my work appeared to be valuable, and often led to a clearer vision of the problems I was dealing with.

The STW User's Committee has contributed largely in specifying the problems, that the process industry deals with, and in pointing to possible solution strategies. I want to thank Dr. Van den Boom (Eindhoven University of Technology), Dr. Eder (ACT GmbH, Buro Brussel), Mr. Van Rhijn (ESSO), Mr. Shakouri (Heineken), Mr. Veen (STW), Prof. Verbruggen and Dr. Verhaegen (Delft University of Technology) for their valuable contributions. Special thanks go to Mr. Van Rhijn, for enabling us to do the experiments at the ESSO refinery.

The Master's students I guided are gratefully acknowledged for their various contributions, especially Jan van Osch for his work on closed-loop identification, Ahmet Polat for his

work on lattice algorithms, Gijs de Reuver and Stefan Schinkel for their work on input design, and Gert van Ingen for conducting the ESSO experiment and analyzing the data.

The courses of the Dutch Graduate School of Systems and Control have provided me with a wealth of information and theoretical background, needed for my research. For this I want to thank the respective teachers.

I want to thank my colleagues at the Control Laboratory for the pleasant working atmosphere. Especially André, Gerhard, Rogier and Ton are mentioned for the discussions we had on various items, both academic and nonacademic, and Robert Jan, who was the intermediary between Eindhoven and Delft concerning the printing of my concepts. The AIO's at the Mechanical Engineering Systems and Control Group are gratefully acknowledged for the fruitful discussions on various aspects of identification, and for the discussions at conferences abroad. Mrs. Zaat-Jones is kindly acknowledged for her revisions of my American text.

I am indebted to my parents for their continuous support throughout these four years. My girlfriend Annelous deserves the greatest thanks for motivating and supporting me in difficult times. She was as happy as I was, when another chapter was finished.

---

## *Curriculum Vitae*

Alexander Christiaan van der Klauw was born on September 10, 1967, in Enschede. He attended the "Erasmiaans Gymnasium" in Rotterdam, from which he graduated in 1985. He then studied Electrical Engineering at the Delft University of Technology. He graduated in 1990 on a project with ADERSA in France, on the predictive control of flexible systems.

In September 1990 he started as a researcher on the project "Closed-loop identification in the process industry", financed by the Dutch Technology Foundation (STW). During this time his research was directed toward closed-loop identification. He also co-taught a course on Modeling, Identification and Simulation, of which the lecture notes have been published by CRC Press.

Currently he is employed by Unilever, Corporate Manufacturing and Engineering Group (CMEG).





---

# *Index*

## **A**

a priori knowledge, 91  
accumulator, 132  
Akaike's Information Criterion, 48  
assumptions, 19  
asymptotic, 15

## **B**

backward model, 57  
basic IV, 17  
basis transformation, 44  
bias, 92  
    distribution, 16  
black-box, 2  
block selection rule, 46  
bootstrap IV, 17  
bottoms product, 132

## **C**

chain selection rule, 46  
closed-loop, 4  
    configuration, 19  
condenser, 132  
condition number, 99  
consistent, 11, 13  
constraints, 92  
control-design filters, 80  
controller design, 77  
convergence, 64  
correlation analysis, 126  
Cramèr-Rao bound, 93  
criterion  
    experiment design, 93  
    global, 79  
    input design, 99  
    local, 80

cross-validation, 125  
cutpoint, 132

## **D**

data preprocessing, 137  
data reduction, 10  
data vector, 53  
    filtered, 56  
dead time, 40  
decimation, 139  
determinant, 99, 121  
DI, 23  
distillate, 132  
distillation column, 130  
distortion method, 126

## **E**

excitation signal, 122  
experiment design, 91  
extended scheme, 85

## **F**

feed, 131  
feedback, 5  
feedforward, 5  
filtered white noise, 102, 112  
Final Prediction Error, 48  
Fisher's information matrix, 93  
forgetting factor, 54  
forward model, 57  
frequency function, 93  
    variance, 97

## **G**

GBN, 102, 113  
Generalized Binary Noise, 102, 113, 136

GI, 34

gray-box, 2

## H

Hankel matrix, 45

Hessian, 94

hypothesis test, 41

## I

identification, 2, 77

    closed-loop, 19, 117

    control-relevant, 75, 87

    criterion, 15

        global, 81

        local, 82

    Direct, 23, 81, 119, 123

    filter, 35, 82, 84

    Generalized, 34, 119, 124

    global, 93, 94

    Indirect, 25

    open-loop, 9

    parametric, 10

    recursive, 52

II, 25

IMC, 132

impurity, 132

input design problem, 92, 109

input protocol, 92, 101

input sensitivity, 20

input signal, 136

instrumental variable, 17, 29

instruments

    basic, 29

    noise-free, 30

internal loop, 84

Internal Model Control, 132

iso- $V$ , 94

iterative, 75, 77

IV, 29

## J

JIO, 26

Joint Input Output, 26

## L

Lattice

    Bootstrap Instrumental Variable, 63

    Extended Least Squares, 62

    Output Error, 62

    Prediction Error Method, 60

    Pseudo Linear Regression, 61

lattice algorithms, 51

lattice parameter, 59

lattice regressor, 59

LBIV, 63

LELS, 62

location, 122

LOE, 62

LPEM, 60

LPLR, 61

LQ controller design, 79

## M

Markov parameters, 45

model error, 92

model set, 12

model structure, 12, 43, 46

    selection, 48

model validation, 125

    objective, 125

    subjective, 125

modeling, 2

monitoring, 87

multi-index, 46

multisine, 101, 111, 115

## N

nice selection, 46

noise model, 85

nonswitching probability, 102

## O

optimal IV, 18

ORTFIR, 42

orthogonal FIR, 42  
orthogonalization, 51, 57  
orthonormal basis, 41  
outliers, 138  
output sensitivity, 20

## P

parallel filtering, 140  
parameter estimate, 94  
parameter vector, 12  
    true, 13  
parametrization, 12  
    canonical, 44  
    independent, 13  
    overlapping, 44  
    pseudo-canonical, 44  
PEM, 14  
performance, 76  
    achieved, 76  
    degradation, 77  
persistently exciting, 10  
pole-placement, 78  
prediction error, 15, 52  
    backward, 58  
    forward, 58  
Prediction Error Method, 14  
problem, 6  
process industry, 1  
    characteristics, 3

## R

reboiler, 132  
reflection coefficient  
    backward, 59  
    forward, 59  
reflux, 132  
regression, 14  
    vector, 53  
requirements, 19  
residual, 52, 126  
    backward, 57  
    forward, 57

residue, 132

## S

sampling time, 136  
scaling, 139  
sensitivity, 98  
series expansion, 42  
smallest eigenvalue, 99, 121  
smallest singular value, 99  
spectral analysis, 11, 21  
spectral factorization, 28  
stochastic realization, 28  
stop criterion, 87  
structure index, 39, 46  
Subspace Model Identification, 43  
system, 10

## T

time delay, 40, 140  
top product, 132  
trace, 122  
tray, 131  
trend, 138  
triangle inequality, 77  
TS, 31  
Two-Step, 31, 118

## U

uncertainty region, 94  
uniquely identifiable, 43, 44  
upper bound, 88

## V

vapor pressure, 130  
variance, 92

## W

weights, 120  
white-box, 2  
windowing, 11  
windsurfer approach, 78

## Z

Zang scheme, 78, 79