

System Identification

Lecture 12

Closed-loop identification

Contents

Introduction

Direct identification method

Indirect methods

Consistency

Asymptotic variance

Approximations

Introduction

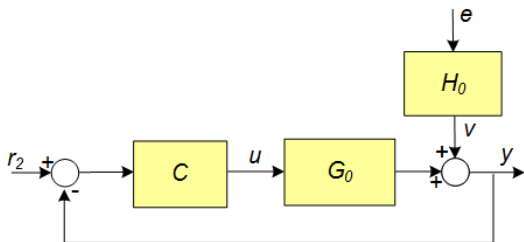

- Usual operation of many plants
- Particularly when processes are unstable
- Linearizing effect of controller

r_2 is reference or setpoint signal

Principle difference with OL situation: u and v correlated.

The closed-loop problem

System set-

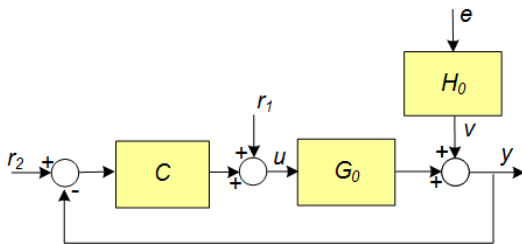

Available data:

- 1 $(u(t), y(t))$, $t = 1, \dots, N$ are measured
- 2 Additionally $r_1(t)$ or $r_2(t)$, $t = 1, \dots, N$ might be measured
- 3 Knowledge of $C(q)$ might be used

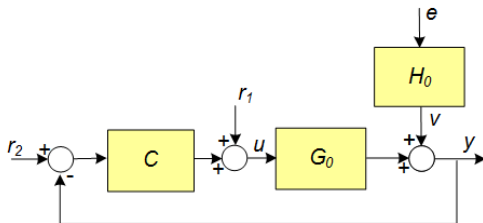

For ease of notation:
introduce $r(t) := r_1(t) + C(q)r_2(t)$.

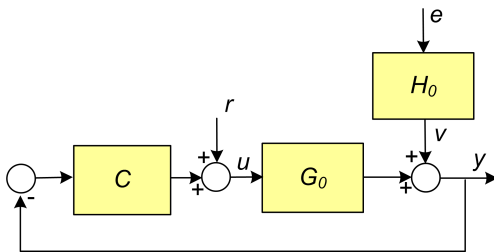

System's equations:

$$u = r - Cy$$

$$y = G_0 u + v$$

leading to:

$$y = \frac{G_0}{1 + CG_0} r + \frac{1}{1 + CG_0} v$$

$$u = \frac{1}{1 + CG_0} r - \frac{C}{1 + CG_0} v$$

Using the sensitivity function: $S_0 := \frac{1}{1 + CG_0}$

the system relations become:

$$y = G_0 S_0 r + S_0 v$$

$$u = S_0 r - CS_0 v$$

Example (“is there a problem?”) – Spectral analysis

Suppose that we make a nonparametric spectral analysis/ETFE estimate on the basis of u and y only

$$\hat{G}(e^{i\omega}) = \frac{\Phi_{yu}(\omega)}{\Phi_u(\omega)}; \quad \begin{aligned} y(t) &= S_0 [G_0 r(t) + v(t)] \\ u(t) &= S_0 [r(t) - Cv(t)] \end{aligned}$$

Then

$$\begin{aligned} \Phi_u(\omega) &= |S_0|^2 [\Phi_r(\omega) + |C|^2 \Phi_v(\omega)] \\ \Phi_{yu}(\omega) &= |S_0|^2 [G_0 \Phi_r(\omega) - C^* \Phi_v(\omega)] \end{aligned}$$

and so:

$$\hat{G} = \frac{\Phi_{yu}(\omega)}{\Phi_u(\omega)} = \frac{G_0 \Phi_r(\omega) - C^* \Phi_v(\omega)}{\Phi_r(\omega) + |C|^2 \Phi_v(\omega)}$$

$$\hat{G}(e^{i\omega}) = \frac{G_0\Phi_r(\omega) - C^*\Phi_v(\omega)}{\Phi_r(\omega) + |C|^2\Phi_v(\omega)}$$

Limit cases:

$$\Phi_v(\omega) = 0 \quad \text{no noise} \quad \Rightarrow \quad \hat{G} = G_0$$

$$\Phi_r(\omega) = 0 \quad \text{no excitation} \quad \Rightarrow \quad \hat{G} = -1/C$$

There are two dynamical relationships between u and y (forward and backward)

A linear combination of the two is estimated dependent on the signal to noise ratio

Example: identifiability / lack of input excitation

Consider $\mathcal{S} \in \mathcal{M}$ for an ARX model set:

$$y(t) + ay(t-1) = bu(t-1) + e(t).$$

Controller: $u(t) = f \cdot y(t)$ (without external excitation)

Prediction error:

$$\begin{aligned}\varepsilon(t, \theta) &= y(t) + ay(t-1) - bu(t-1) \\ &= y(t) + (a - bf)y(t-1)\end{aligned}$$

and all models (\hat{a}, \hat{b}) such that $\hat{a} = a_0 + \gamma f$, $\hat{b} = b_0 + \gamma$ give the same prediction error for any $\gamma \in \mathbb{R}$. Knowledge of f does not help.

No unique model can be estimated (not enough excitation)

Possible way out when external excitation r is present, follows from system equations:

$$\begin{aligned}y &= G_0 S_0 r + S_0 v \\u &= S_0 r - C S_0 v\end{aligned}$$

When r and v are uncorrelated, the two equations actually reflect two open-loop systems (with input r)

Note that

$$G_0 = \frac{G_{yr}}{G_{ur}}$$

where G_{yr} and G_{ur} can be estimated either parametrically or nonparametrically.

Two principle approaches:

- Direct identification (based on u and y only)
Which part of the (open-loop) theory can still be used?
- Indirect identification (based on u , y and (r and/or C))

Which results are we going to focus on:

- Consistency of (\hat{G}, \hat{H}) (situation $\mathcal{S} \in \mathcal{M}$)
- Consistency of \hat{G} (situation $G_0 \in \mathcal{G}$)
- Asymptotic variance properties

Direct identification method

Leading principle:

Use measured y, u and identify a -standard- model by “neglecting” the presence of C

Analysis results

Convergence result (Chapter 5) is valid also under closed-loop conditions:

$$\hat{\theta}_N \rightarrow \theta^* \quad \text{w.p. 1 as } N \rightarrow \infty$$

with

$$\theta^* = \arg \min_{\theta} \bar{V}(\theta) = \arg \min_{\theta} \bar{\mathbb{E}} \varepsilon^2(t, \theta)$$

Principle question:

Does $\min \bar{V}(\theta)$ lead to models with desired properties?

Combining:

$$\begin{aligned}y(t) &= G_0 u(t) + H_0 e(t) \\u(t) &= r(t) - C y(t) \\ \varepsilon(t, \theta) &= H(\theta)^{-1} [y(t) - G(\theta) u(t)]\end{aligned}$$

delivers:

$$\varepsilon(t, \theta) = \underbrace{\frac{(G_0 - G(\theta))}{H(\theta)(1 + CG_0)}}_{T_{\varepsilon r}(q, \theta)} r(t) + \underbrace{\frac{H_0(1 + CG(\theta))}{H(\theta)(1 + CG_0)}}_{T_{\varepsilon e}(q, \theta)} e(t)$$

If CG_0 and $CG(\theta)$ are strictly proper (i.e. the products contain a delay), then

$T_{\varepsilon e}(q, \theta)$ is *monic*

This requires that there is no algebraic loop in the system:

$$\lim_{z \rightarrow \infty} C(z)G_0(z) = 0.$$

$$\varepsilon(t, \theta) = \underbrace{\frac{(G_0 - G(\theta))}{H(\theta)(1 + CG_0)}}_{T_{\varepsilon r}(q, \theta)} r(t) + \underbrace{\frac{H_0(1 + CG(\theta))}{H(\theta)(1 + CG_0)}}_{T_{\varepsilon e}(q, \theta) \text{ monic}} e(t)$$

Minimum of $\bar{E}\varepsilon(t, \theta)^2$ is achieved for

- $T_{\varepsilon r}(q, \theta^*) = 0$
- $T_{\varepsilon e}(q, \theta^*) = 1$

(provided that r is persistently exciting)

$$\begin{aligned}T_{\varepsilon r}(q, \theta^*) = 0 &\Rightarrow \frac{(G_0 - G(\theta^*))}{H(\theta^*)(1 + CG_0)} = 0 \\ &\Rightarrow G(q, \theta^*) = G_0(q)\end{aligned}$$

This, together with

$$T_{\varepsilon e}(q, \theta^*) = 1 \Rightarrow \frac{H_0(1 + CG(\theta^*))}{H(\theta^*)(1 + CG_0)} = 1$$

implies that $H(q, \theta^*) = H_0(q)$.

Consistency result of direct method

If $\mathcal{S} \in \mathcal{M}$, r is sufficiently **exciting**, and there are no **algebraic loops** in closed-loop system and parametrized models, then

$$G(q, \theta^*) = G_0(q); \quad H(q, \theta^*) = H_0(q)$$

i.e. $G(q, \hat{\theta}_N)$ and $H(q, \hat{\theta}_N)$ are consistent estimates.

- Open-loop consistency result seems to be fully valid for the closed-loop case!

However:

Note: There is no consistency result for only $G_0 \in \mathcal{G}$.

$$\varepsilon(t, \theta) = \underbrace{\frac{(G_0 - G(\theta))}{H(\theta)(1 + CG_0)}}_{T_{\varepsilon r}(q, \theta)} r(t) + \underbrace{\frac{H_0(1 + CG(\theta))}{H(\theta)(1 + CG_0)}}_{T_{\varepsilon e}(q, \theta) \text{ monic}} e(t)$$

- If $H(\theta) \neq H_0$, then bringing $T_{\varepsilon e}(q, \theta)$ “close to monic” needs to be comprised with making $T_{\varepsilon r}(q, \theta)$ “close to 0”.
- This is due to the presence of $G(\theta)$ in $T_{\varepsilon e}(q, \theta)$.

The excitation condition on r can actually be relaxed.

It is sufficient for consistency in the case $\mathcal{S} \in \mathcal{M}$, that for any two models $M_1 = (G_1, H_1)$, $M_2 = (G_2, H_2)$ in \mathcal{M} with predictor filters

$$W_i = [H_i^{-1}G_i \quad 1 - H_i^{-1}] \quad i = 1, 2$$

it holds that

$$\mathbb{E} \left\{ \left[[W_1(q) - W_2(q)] \begin{pmatrix} u(t) \\ y(t) \end{pmatrix} \right]^2 \right\} = 0 \implies W_1 = W_2$$

Notion: **Data set is informative w.r.t. \mathcal{M}**

It guarantees that $\bar{V}(\theta) = \bar{V}(\theta_0)$ implies $\theta = \theta_0$

Rewriting the “power is 0” condition to the frequency domain:

$$\frac{1}{2\pi} \int_{-\pi}^{\pi} \tilde{W}(e^{i\omega}) \Phi_z(\omega) \tilde{W}^T(e^{i\omega}) d\omega = 0$$

with $\tilde{W} = W_1 - W_2$, and

$$\Phi_z(\omega) = \begin{bmatrix} \Phi_u(\omega) & \Phi_{uy}(\omega) \\ \Phi_{yu}(\omega) & \Phi_y(\omega) \end{bmatrix}$$

it follows that informativity is guaranteed if

$$\Phi_z(\omega) > 0 \quad \forall \omega$$

This can be achieved by

- Presence of an exciting r , or
- A controller of sufficiently high order, or
- A time-varying or nonlinear controller

Question:

Where did the ARX-example from slide 9 go wrong?

Question:

Can we use identification techniques that rely on periodic input signal u ?

Summary direct identification method

- Consistent estimates in the situation $\mathcal{S} \in \mathcal{M}$, under excitation conditions
- Excitation conditions can be realized by either presence of r or through input excitation through the noise process
- No consistency when only $G_0 \in \mathcal{G}$
- No “free” excitation of input u ; periodic excitation of u is not feasible

Indirect identification methods

Main step with respect to direct methods:

- Additional use of measured r and/or controller C

Several indirect methods are all closely related:

- Nonparametric
- Coprime factor method
- Projection methods (Two-stage and Instrumental variable (IV)-method)
- Classical indirect

1. Non-parametric / coprime factor method

$$\hat{G} = \frac{\Phi_{yr}(\omega)}{\Phi_{ur}(\omega)}$$

i.e. based on **nonparametric** frequency response estimates of

$$G_{yr} = \frac{G_0}{1 + CG_0} \quad \text{and} \quad G_{ur} = \frac{1}{1 + CG_0}.$$

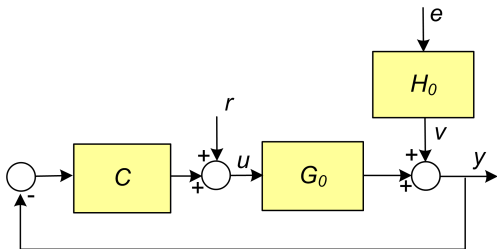

1. Non-parametric / coprime factor method

- Using reference excitation to identify two “open-loop” systems, and take quotient
- Any desired excitation (e.g. periodic) can be used for r .

Can be done with **parametric models** (coprime factors of G_0).

- $\hat{G} = \frac{\hat{G}_{yr}}{\hat{G}_{ur}}$
- Hard to control the order of G_0 (because of quotient)
- Using filtered versions of r as input, can help in low-order representations of G_0

2. Projection methods (two-stage / IV)

Approach

- Decompose the input signal u into

$$u(t) = u^r(t) + u^e(t)$$

i.e. the components of u that result from r and e respectively. Since r and e are uncorrelated this implies that both u -components are uncorrelated too.

- Then

$$y(t) = G_0 u^r(t) + \underbrace{G_0 u^e(t) + H_0 e(t)}_{\text{disturbance terms}}.$$

- Identify G_0 (and possibly a noise model), based on input u^r and output y . This is basically an open-loop problem.

2. Projection methods (two-stage / IV)

- Typically G_0 is identified with a parametric model
- The model order of \hat{G} can directly be prespecified (contrast with coprime factor method)

How to construct (an estimate of) u^r ?

- Identify the transfer function G_{ur} on the basis of r and u (open-loop problem)
- Simulate:

$$\hat{u}^r(t) = \hat{G}_{ur}(q)r(t)$$

- Use $\hat{u}^r(t)$ as input signal in the identification of G_0 .

3. Classical indirect method

Approach

- Identify $G_{yr} = \frac{G_0}{1+CG_0}$ on the basis of r and y
- Use the knowledge of C to derive an estimate of G_0 : Choose \hat{G} such that

$$\hat{G}_{yr} = \frac{\hat{G}}{1 + C\hat{G}}$$

i.e.

$$\hat{G} = \frac{\hat{G}_{yr}}{1 - C\hat{G}_{yr}}.$$

- Like with the coprime factor method, the model order of \hat{G} is a result of the manipulations

Consistency

Direct method

Consistency of (G, H) can be obtained in the situation $\mathcal{S} \in \mathcal{M}$.

Indirect methods

Consistency of G can be obtained in the situation $G_0 \in \mathcal{G}$.

Asymptotic variance

Direct method

- The variance results of the open-loop situation remain valid, provided that we have consistency ($\mathcal{S} \in \mathcal{M}$).
- This includes the **Maximum Likelihood properties** of the estimates (minimum variance asymptotically)
- Asymptotic-in-order-of- G result for $n, N \rightarrow \infty$, and noise model in model set:

$$\text{var} \hat{G}(e^{i\omega}) \sim \frac{n \Phi_v(\omega)}{N \Phi_u(\omega)}$$

- In the case $\mathcal{S} \in \mathcal{M}$ the full input signal u is used for identification.

Asymptotic variance

Indirect methods

- Typically the reference signal r is used as input for identification;
- Typical variance result (asymptotic in model order n and in N):

$$\text{var} \hat{G}(e^{i\omega}) \sim \frac{n}{N} \frac{\Phi_v(\omega)}{\Phi_{u^r}(\omega)}$$

valid in the situation $G_0 \in \mathcal{G}$.

- Only the reference-part of the input signal contributes to variance reduction.
- Neglecting u^e as input signal contributes to a worse SN-ratio.

Bias expressions - Approximations

Bias in direct closed-loop identification

$$\hat{\theta}_N \rightarrow \theta^* = \arg \min_{\theta} \bar{V}(\theta); \quad \bar{V}(\theta) = \bar{\mathbb{E}} \varepsilon_f^2(t, \theta)$$

By Parseval, $\bar{V}(\theta) =$ (see slide 13)

$$\frac{1}{2\pi} \int_{-\pi}^{\pi} \left\{ \left| \frac{G_0 - G(\theta)}{1 + CG_0} \right|^2 \Phi_r + \left| \frac{1 + CG(\theta)}{1 + CG_0} \right|^2 \Phi_v \right\} \frac{|L|^2}{|H(\theta)|^2} d\omega$$

No explicit (tunable) approximation criterion for $G(\theta)$,
since $G(\theta)$ appears in both terms of the integrand

Bias in indirect closed-loop identification

Bias expressions for “all” indirect alternatives

$$\theta^* = \arg \min_{\theta} \int_{-\pi}^{\pi} \left| \frac{G_0}{1 + CG_0} - \frac{G(\theta)}{1 + CG(\theta)} \right|^2 \frac{\Phi_r |L|^2}{|K|^2} d\omega$$

(with slight variations) and K a fixed noise model.

Closed-loop properties of the plant ($G_0 S_0$) are best approximated.

Note

$$\frac{G_0}{1 + CG_0} - \frac{G(\theta)}{1 + CG(\theta)} = \frac{G_0 - G(\theta)}{(1 + CG_0)(1 + CG(\theta))}$$

“Additive error” is weighted with sensitivity of plant and model.

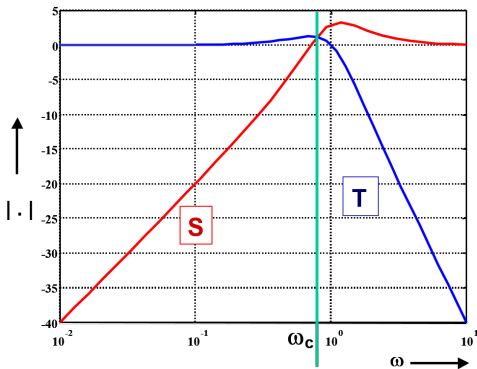

Typical curve for Bode magnitude plot of **sensitivity function S_0** and related **complementary sensitivity $G_0C/(1 + CG_0)$** .

Model errors are highly weighted around the cross-over frequency of the closed-loop.

Main properties of the different methods

	Direct	Cop-Fac	Two-St	Clas.Ind.
Consistency (\hat{G}, \hat{H})	+	+	+	+
Consistency \hat{G}	-	+	+	+
Tunable bias	-	+	+	+
Fixed model order	+	-	+	-
Variance	+	-	-	-
C assumed known	no	no	no	yes
C assumed linear	no	yes	yes	yes

Model validation in closed-loop

- For all **indirect methods**:
validation with correlation tests as in open-loop
- For **direct method**: Careful with test on $R_{\varepsilon u}(\tau)$.

$$\begin{aligned}\varepsilon(t, \theta) &= H(\theta)^{-1}[(G_0 - G(\theta))u(t) + H_0 e(t)] \\ R_{\varepsilon u}(\tau) &= H(\theta)^{-1}[G_0 - G(\theta)]R_u(\tau) + H(\theta)^{-1}H_0 R_{eu}(\tau).\end{aligned}$$

Can the second term influence the cross-correlation test?

$R_{eu}(\tau)$ will have a contribution for $\tau < 0$ only.

The second term can then have a contribution for $\tau > 0$ if the filter $H(\theta)^{-1}H_0$ has dynamics, i.e. when the noise model is incorrect.

For the direct method the residual tests should not be interpreted independently (validation of \hat{G} and \hat{H} simultaneously).

Summary - Closed-loop identification

- **Nonparametric** estimation in closed-loop needs to be done in an **indirect way** (using a reference r)
- Parametric models can be consistently identified with a **direct method**
- but only through modelling G and H simultaneously ($\mathcal{S} \in \mathcal{M}$)
- **Indirect methods** can provide consistent estimates in the situation $G_0 \in \mathcal{G}$
- Direct methods lead to **smaller variance** (ML-properties)
- In closed-loop identification, the frequency area around the **cross-over frequency** of the closed-loop system, typically is most dominantly present in the plant data/models.

Extensions / challenges Distributed/networked systems

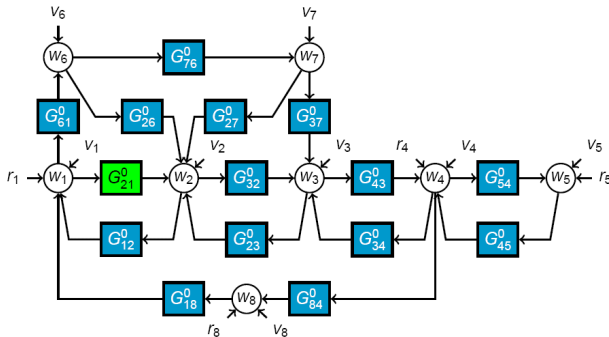

- Local and global identification; identifiability
- Where best to excite and to sense?
- Prior knowledge of blocks

e.g. Van den Hof, Dankers et al., Automatica 2013, 2015; IEEE Trans. Autom. Control, 2016.